

MATHEMATICS

STANDARD FIVE

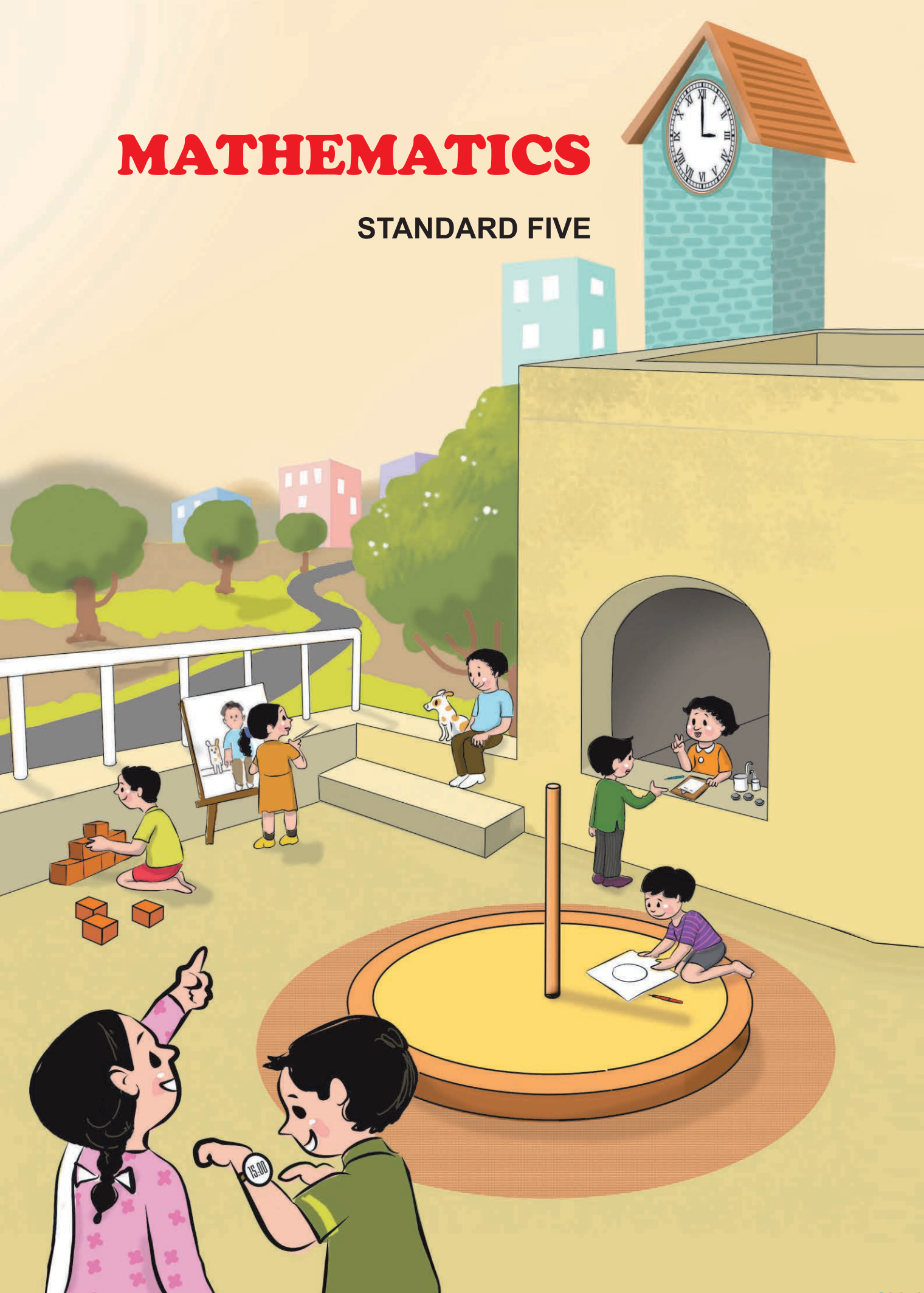

Education Department's Sanction Number :
Pra-Shi-Sa/2014-15/149/Manjuri/D-505/344, Date 14/1/2015

MATHEMATICS

STANDARD FIVE

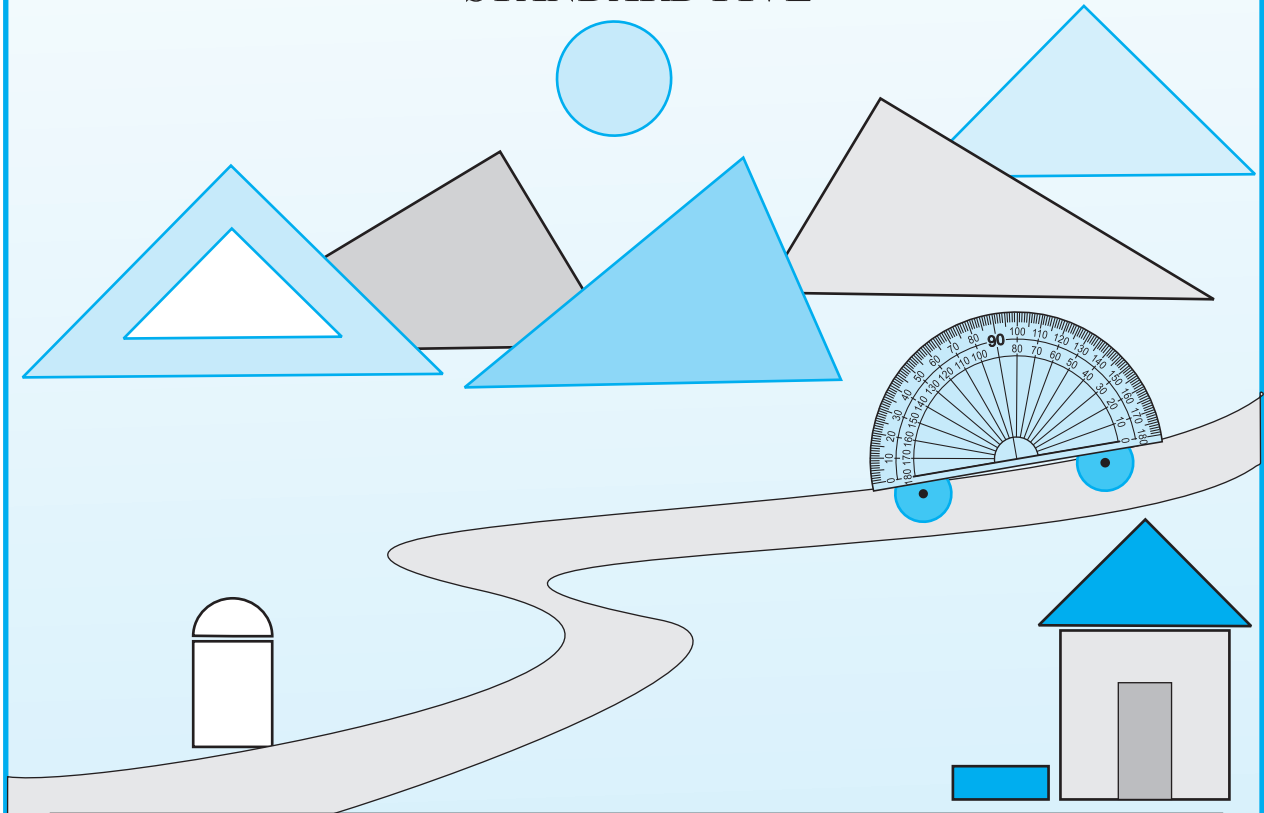

The digital textbook can be obtained through DIKSHA App on a smartphone by using the Q. R. Code given on title page of the textbook and useful audio-visual teaching-learning material of the relevant lesson will be available through the Q. R. Code given in each lesson of this textbook.



**MAHARASHTRA STATE BUREAU OF TEXTBOOK PRODUCTION
AND CURRICULUM RESEARCH, PUNE.**

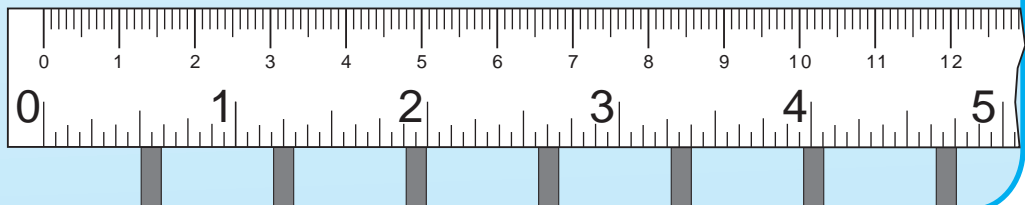

**First Edition : 2015
Fifth Reprint : 2020**

© **Maharashtra State Bureau of Textbook Production and Curriculum Research, Pune - 411 004.**

The Maharashtra State Bureau of Textbook Production and Curriculum Research reserves all rights relating to the book. No part of this book should be reproduced without the written permission of the Director, Maharashtra State Bureau of Textbook Production and Curriculum Research, Pune.

Mathematics Subject Committee

Dr Shashikant A. Katre (Chairman)
Dr Smt. Mangala Naralikar (Member)
Dr Vinayak M. Solapurkar (Member)
Dr Smt. Vaijayanta Patil (Member)
Dr K. Subramaniam (Member)
Shri. Rajendra Gosavi (Member)
Shri. Pramod T. Kharche (Member)
Smt. Mangal Pawar (Member)
Smt. Ujjwala Godbole
(Member - Secretary)

Cover and Illustrations :

Reshma Barve, Pune.

Computer Drawings :

Sandeep Koli, Mumbai.

Co-ordination :

Ujjwala S. Godbole
I/C Special Officer for Mathematics

Translation : Smt. Mrinalini Desai

Scrutiny : Dr Mangala Naralikar

Co-ordination :

Dhanavanti Hardikar
Academic Secretary (Languages)
Santosh J. Pawar
Assistant Special Officer, English

Mathematics Panel

Dr M. M. Shikare
Dr Kailas Bondarde
Dr Jayashri Atre
Dr Anil Vaidya
Shri. Hemant Deshpande
Shri. Nagesh Mone
Shri. Ravindra Yewale
Shri. Purushottam Sharma
Shri. Suresh Shinde
Smt. Bharati Tathe
Shri. Kalyan Shinde
Shri. Pradeep Godase
Shri. Sudhir Nachane
Shri. Rajesh Vairagade
Smt. Vaishali Patil
Shri. Maruti Baraskar

Production :

Sachchitanand Aphale, Chief Production Officer
Sanjay Kamble, Production Officer
Prashant Harne, Assistant Production Officer

Typesetting : DTP Section (Languages)
Textbook Bureau, Pune.

Paper : 70 GSM Cream wove

Printer : HEXAGON PRINT & PACK PVT. LTD.,
PALGHAR

Print Order No. : N/PB/2020-21/75,000

Publisher :

Vivek Uttam Gosavi, Controller
Maharashtra State Textbook Bureau,
Prabhadevi, Mumbai - 400 025.



The Constitution of India

Preamble

WE, THE PEOPLE OF INDIA, having solemnly resolved to constitute India into a SOVEREIGN SOCIALIST SECULAR DEMOCRATIC REPUBLIC and to secure to all its citizens:

JUSTICE, social, economic and political;

LIBERTY of thought, expression, belief, faith and worship;

EQUALITY of status and of opportunity; and to promote among them all

FRATERNITY assuring the dignity of the individual and the unity and integrity of the Nation;

IN OUR CONSTITUENT ASSEMBLY this twenty-sixth day of November, 1949, do HEREBY ADOPT, ENACT AND GIVE TO OURSELVES THIS CONSTITUTION.

NATIONAL ANTHEM

Jana-gana-mana-adhināyaka jaya hē
Bhārata-bhāgya-vidhātā,

Panjāba-Sindhu-Gujarāta-Marāthā
Drāvida-Utkala-Banga

Vindhya-Himāchala-Yamunā-Gangā
uchchala-jaladhi-taranga

Tava subha nāmē jāgē, tava subha āsisa māgē,
gāhē tava jaya-gāthā,

Jana-gana-mangala-dāyaka jaya hē
Bhārata-bhāgya-vidhātā,

Jaya hē, Jaya hē, Jaya hē,
Jaya jaya jaya, jaya hē.

PLEDGE

India is my country. All Indians
are my brothers and sisters.

I love my country, and I am proud
of its rich and varied heritage. I shall
always strive to be worthy of it.

I shall give my parents, teachers
and all elders respect, and treat
everyone with courtesy.

To my country and my people,
I pledge my devotion. In their
well-being and prosperity alone lies
my happiness.

Preface

The 'Primary Education Curriculum - 2012' was prepared in the State of Maharashtra following the 'Right of Children to Free and Compulsory Education Act, 2009' and the 'National Curriculum Framework 2005'. The Textbook Bureau has launched a new series of Mathematics textbooks based on this syllabus approved by the State Government from the academic year 2013-2014. We are happy to place this textbook of Standard Five in this series in your hands.

Our approach while designing this textbook was that the entire teaching-learning process should be child-centred, emphasis should be given on active learning and constructivism and at the end of Primary Education the students should have attained the desired competencies and that the process of education should become enjoyable and interesting.

Children constantly try to 'do' things on their own. Considering this factor, we have tried to make this book activity-oriented. For this, instructions and many activities have been given. Illustrations and diagrams have been used in the textbook to lead to a clearer understanding of mathematics.

Graded problem sets have been included in order to ensure revision and reinforcement of mathematical concepts and to facilitate self-learning. It is expected that the children will solve the questions in these problem sets on their own. Activity-oriented and open ended questions have also been included in the problem sets. We have tried to provide a variety of exercises to make them interesting for the students.

The language of presentation that the teacher is expected to use has been provided in the form of dialogues in the textbook. Some properties and rules that students need to use again and again while studying mathematics have been given in boxes. We have tried to make the subject lively with games, puzzles, etc.

This book was scrutinized by teachers, educationists and experts in the field of mathematics at all levels and from all parts of the State to make it as flawless and useful as possible. Letters from teachers and parents have been taken into account and their comments and suggestions have been duly considered by the Mathematics Subject Committee while finalising the book.

The Mathematics Subject Committee and Panel of the Textbook Bureau, Shri. V.D. Godbole (Invitee) and the artist have taken great pains to prepare this book. The Bureau is thankful to all of them.

We hope that this book will receive a warm welcome from students, teachers and parents.



(C. R. Borkar)

Director



Maharashtra State Bureau of Textbook
Production and Curriculum Research, Pune.



Pune

Date : November 27, 2014

Agrahayan 6, 1936

English Mathematics - Standard V-Learning Outcomes

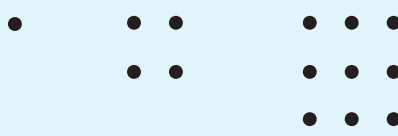
Suggested Pedagogical Processes	Learning Outcomes
<p>The learners may be provided opportunities in pairs/groups/ individually and encouraged to —</p> <ul style="list-style-type: none"> discuss on contexts/situations in which a need arises to go beyond the number 1000 so that extension of number system occurs naturally. For example, number of grams in 10 kg, number of metres in 20 km, etc. represents numbers beyond 1000 (up to 100000) using place value system, like extend learning of numbers beyond 9 thousand, how to write number one more than 9999 operate (addition and subtractions) large numbers using standard algorithm. This may be identified as extension of algorithm for one more place use a variety of ways to divide numbers like equal distribution and inverse process of multiplication develop the idea of multiples of a number through its multiplication facts, skip counting on a number-line and number grid develop the concept of factors through division of numbers and multiples estimate the results of number operation through approximations and then verifies it classify the numbers with properties, for example, prime numbers, co-prime numbers etc. discuss and use contexts/ situations from daily life in activities to develop understanding about fractional part of the group like, how many bananas are there in half a dozen bananas? compares fractions through various ways like paper folding, shading of diagram etc. develop the idea of equivalence of fractions through various activities. For example, by paper folding and shading: <div style="display: flex; align-items: center; margin-bottom: 10px;">  <div style="margin-left: 10px;"> $\frac{1}{2}$ is the same as </div> </div> <div style="display: flex; align-items: center;">  <div style="margin-left: 10px;"> $\frac{2}{4}$ </div> </div> <ul style="list-style-type: none"> understand the idea of decimal fractions ($\frac{1}{10}$ th and $\frac{1}{100}$ th) develop earlier understanding of angles and to describe it 	<p>The learner —</p> <p>05.71.01 works with large numbers.</p> <ul style="list-style-type: none"> reads and writes numbers bigger than 1000 being used in her/his surroundings. performs four basic arithmetic operations on numbers beyond 1000 by understanding of place value of numbers. divides a given number by another number using standard algorithms. estimates sum, difference, product and quotient of numbers and verifies the same using different strategies like using standard algorithms or breaking a number and then using operation. For example, to divide 9450 by 25, divide 9000 by 25, 400 by 25, and finally 50 by 25 and gets the answer by adding all these quotients. <p>05.71.02 Identifies the classification of prime numbers and coprime numbers.</p> <p>05.71.03 acquires understanding about fractions.</p> <ul style="list-style-type: none"> finds the number corresponding to part of a collection. identifies and forms equivalent fractions of a given fraction. expresses a given fraction $\frac{1}{2}$, $\frac{1}{4}$, $\frac{1}{5}$ in decimal notation and vice versa. For example, in using units of length and money– half of Rs. 10 is Rs.5. converts fractions into decimals and vice versa. <p>05.71.04 explores idea of angles and shapes. Classifies angles into right angle, acute angle, obtuse angle and represents the same by drawing and tracing.</p> <p>05.71.05 relates different commonly used larger and smaller units of length, weight and volume and converts larger units to smaller units and vice versa.</p> <p>05.71.06 estimates the volume of a container in known units like volume of a bucket is about 20 times that of a mug.</p>

Suggested Pedagogical Processes	Learning Outcomes
<ul style="list-style-type: none"> • observe angles in their surroundings and compare their measures. For example, whether the angle is smaller, bigger or equal to the corner of a book which is a right angle; further, classify the angles • introduce protractor as a tool for measuring angles and use it to measure and draw angles • plan their shopping— to make estimates of money (in different denominations) and the balance money one would get • conducts role play of shopkeepers/ buyers in which students create bills • measure length of different objects using a tape/ metre scale • appreciates the need of converting bigger units to smaller units • discuss experiences on units of capacity printed on water bottle, soft drink pack, etc. • fill a given space by using different solid shapes, cubes, cuboids, prisms, spheres, etc. and encourage students to decide which solid shape is more appropriate • measure volume by counting the number of unit cubes that can fill a given space • explore patterns in numbers while doing various operations and to generalise them as patterns in square numbers <ul style="list-style-type: none"> •  • triangular number as shown below also forms a pattern <ul style="list-style-type: none"> •  • collect information and display it in a pictorial form. For example, heights of students from their class and represent it pictorially • introduce perimeter or rectangular shapes through blackboard, plane surface of table and books with explaining the concept of closed surface 	<p>05.71.07 makes cube and parallelepiped using nets designed for this purpose.</p> <p>05.71.08 applies the four fundamental arithmetic operations in solving problems involving coins, notes, length, mass, capacity and time intervals.</p> <p>05.71.09 identifies the pattern in triangular number and square number.</p> <p>05.71.10 collects data related to various daily life situations, represents it in tabular form and as bar graphs and interprets it.</p> <p>05.71.11 estimates the perimeter and area of the rectangular shapes in the surroundings. For example, the floor of the classroom, plane surface of chalk-stick box, etc.</p> <p>05.71.12 uses four basic operations (addition, subtraction, multiplication and division) on large numbers.</p>

■ ■ ■ ■ ■ **Contents** ■ ■ ■ ■ ■



Part One

1. Roman Numerals	1
2. Number Work	3
3. Addition and Subtraction	10
4. Multiplication and Division	15
5. Fractions	21
6. Angles	34
7. Circles	41

Part Two

8. Multiples and Factors	46
9. Decimal Fractions.....	52
10. Measuring Time.....	59
11. Problems on Measurement.....	64
12. Perimeter and Area	68
13. Three Dimensional Objects and Nets.	75
14. Pictographs	79
15. Patterns	83
16. Preparation for Algebra.....	86



English Mathematics - Standard V
❖ To the Teacher ❖



The textbook is a very important tool of the teaching-learning process. This textbook has been designed to help you base your teaching of mathematics on your own and your pupils' varied experiences in the local surroundings. We urge you to make full use of the special features of the textbook.

- Explain the mathematical ideas and concepts with the help of the games, stories, practical work, activities and puzzles. Enact the students to dramatise the conversations in the textbook.
- Make the maximum use of practical work for teaching mathematics.
- Have a question-and-answer session based on the subject-content. Use teaching/ learning aids to give learning experience.
- As the children carry out an activity, move amongst the groups to observe what they are doing. Give guidance if necessary.
- Feel free to design activities or make educational materials in addition to the ones given here, and use them for teaching.
- Make consistent efforts to help students develop the ability to read and write numbers and to carry out calculations in their mind.
- Many of the interactions suggested in the syllabus have been included in this textbook. However, other interactions may also be considered.

Part One

1. Roman Numerals

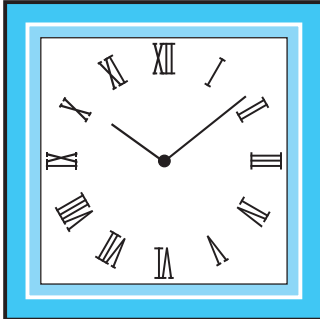

Geeta : This clock doesn't have numbers. It has some symbols instead.

Teacher : Yes, Geeta ! These are Roman numerals. In Europe, in the old times, Roman capital letters were used to write numbers. That is why, they were called Roman numerals. The letter 'I' was the symbol used for 1, 'V' for 5, and 'X' for 10.

In this method, there was no symbol for zero. Also, the value of a symbol did not change with its place. There are certain rules for writing numbers using the Roman numerals. Let us see how to write 1 to 20 using these rules and the symbols I, V and X.

Rule 1 : If either of the symbols I or X is written consecutively two or three times, their sum total is the number they make.

Examples : $II = 1 + 1 = 2$ $XX = 10 + 10 = 20$ $III = 1 + 1 + 1 = 3$

Rule 2 : The symbols I or X can be repeated consecutively for a maximum of three times. The numeral V is never repeated consecutively.

Rule 3 : When either I or V is written on the right of the symbol of a bigger number, its value is added to the value of the bigger number.

Examples : $VI = 5 + 1 = 6$ $XI = 10 + 1 = 11$ $XV = 10 + 5 = 15$
 $VII = 5 + 2 = 7$ $XII = 10 + 2 = 12$ $XVI = 10 + 5 + 1 = 16$
 $VIII = 5 + 3 = 8$ $XIII = 10 + 3 = 13$

Rule 4 : When I is written on the left of V or X, then its value is subtracted from the value of V or X. However, the symbol I is not written more than once before V or X.

Examples : $IV = 5 - 1 = 4$, $IX = 10 - 1 = 9$. But, the number 8 is not written as IIX.

We have to think a little differently to write the numbers 14 and 19.

$14 = 10 + 1 + 1 + 1 + 1$. However, we do not use the symbol I consecutively more than 3 times. Hence, we shall think of the number 14 as $10 + 4$, instead. Then, using the symbol IV for 4, we write 14 as XIV. Similarly, we shall think of the number 19 as $10 + 9$ and write it as XIX.

Thus, to write the numbers from 1 to 20 in Roman numerals, we first distribute a given number into groups of 10, 5 and 1 and then apply the rules given above.

Thus, $12 = 10 + 1 + 1 = XII$, $7 = 5 + 1 + 1 = VII$, $18 = 10 + 5 + 3 = XVIII$

Problem Set 1

1. Write all the numbers from 1 to 20 using Roman numerals.
2. Write the following numbers using international numerals.
 - (1) V (2) VII (3) X (4) XIII (5) XIV (6) XVI (7) XVIII (8) IX
3. Fill in the empty boxes.

Number	Three		Six		Fifteen	
Roman numerals		VIII		XII		XIX

4. Write the numbers using Roman numerals.

- | | | |
|---|--|--|
| (1) 9 <input style="width: 40px; height: 20px;" type="text"/> | (2) 2 <input style="width: 40px; height: 20px;" type="text"/> | (3) 17 <input style="width: 40px; height: 20px;" type="text"/> |
| (4) 4 <input style="width: 40px; height: 20px;" type="text"/> | (5) 11 <input style="width: 40px; height: 20px;" type="text"/> | (6) 18 <input style="width: 40px; height: 20px;" type="text"/> |

5. In the table below, each given number is written in international numerals and then again in Roman numerals. If it is written correctly in Roman numerals, put '✓' in the box under it. If not, put '✗' and correct it.

International numerals	4	6	8	16	15
Roman numerals	III	VI	IIX	XVI	VVV
Right / Wrong (If wrong, correct the numeral.)					

Something more : L, C, D and M are also used as Roman numerals.

Roman numerals	I	V	X	L	C	D	M
Numbers	1	5	10	50	100	500	1000

Activity : Apart from clocks and watches, where else do we see Roman numerals ?

The decimal system of writing numbers

It is not easy to read or write numbers using Roman numerals. It also makes calculations difficult. You have learnt to write numbers using the ten digits, 0 to 9. In that system, the value of a digit depends upon its place in the number. This system of writing numbers is called the 'decimal system'.

Mathematicians of ancient India invented the decimal system of writing numbers and began to use it. Later, this system was accepted in all parts of the world because it was simple and convenient.



2. Number Work



You have learnt to read and write numbers in the decimal system using the ten digits from 0 to 9.

□ Revision

Problem Set 2

- Using the digits 0, 1, 2, 3, 4, 5, 6, 7, 8, 9 write ten each of two-, three-, four- and five-digit numbers. Read the numbers.
- Fill in the blanks in the table below.

Devanagari numerals	International numerals	Number written in words
(1) २,३५९	2,359	Two thousand, three hundred and fifty-nine
(2) ३२,७५६	-----	-----
(3) -----	67,859	-----
(4) १,०३४	-----	-----
(5) -----	-----	Twenty-seven thousand, eight hundred and ninety-five

- As a part of the 'Avoid Plastic Project', Zilla Parishad schools made and provided paper bags to provision stores and greengrocers. Read the talukawise numbers of the bags and write the numbers in words.

Kopargaon	Shevgaon	Karjat	Sangamner
12,740	28,095	31,608	10,972

- How many rupees do they make ?
 - 20 notes of 1000 rupees, 5 notes of 100 rupees and 14 notes of 10 rupees.
 - 15 notes of 1000 rupees, 12 notes of 100 rupees, 8 notes of 10 rupees and 5 coins of 1 rupee.
- Write the biggest and the smallest five-digit numbers that can be made using the digits 4, 5, 0, 3, 7 only once.
- The names of some places and their populations are given below. Use this information to answer the questions that follow.

Tala : 40,642	Gaganbawada : 35,777	Bodhwad : 91,256
Moregaon : 87,012	Bhamragad : 35,950	Velhe : 54,497
Ashti : 76,201	Washi : 92,173	Morwada : 85,890

- Which place has the greatest population ? What is its population ?
- Which place, Morwada or Moregaon, has the greater population ?
- Which place has the smallest population ? How much is it ?

□ Introducing six-digit numbers

Teacher : How much, do you think, is the price of a four-wheeler?

Ajay : Maybe about six or seven lakh rupees.

Teacher : Do you know exactly how much one lakh is?

Ajay : It's a lot, isn't it? More than even ten thousand, right?

Teacher : Yes, indeed! Let's find out just how much. What is $999 + 1$?

Ajay : One thousand.

Teacher : You have learnt to write 99000, too. Now, if you add 1000 to that, you will get one hundred thousand. That's what we call one lakh.

Vijay : $9999 + 1$ is 10,000 (ten thousand). We had made the ten thousands place for it. Can we make a place for one lakh too in the same way?

Teacher : Yes, of course. Carry out the addition $99,999 + 1$ and see what you get.

$$\begin{array}{r} 99,999 \\ + \quad 1 \\ \hline 1,00,000 \end{array}$$

Here we keep carrying over till we have to make a place for the 'lakh' on the left of the ten thousands place. And we write the last carried over one in that place. The sum we get is read as 'one lakh'.

Vijay : Kishakaka bought a second-hand car for two and a half lakh rupees.

Ajay : How much is two and a half lakh?

Teacher : One lakh is 100 thousand. So, half a lakh is 50 thousand. Because, half of 100 is 50.

Vijay : That means two and a half lakh is 2 lakh 50 thousand.

Teacher : Now write this number in figures.

Vijay : 2,50,000.

Teacher : We have seen that a hundred thousand is 1 lakh. If we have 1000 notes of 100 rupees, how many rupees would they make?

Vijay : 1000 notes of 100 rupees would make 1 lakh rupees.



□ Reading six-digit numbers

- (1) 2,35,705 : two lakh thirty-five thousand seven hundred and five (2) 8,00,363 : eight lakh three hundred and sixty-three
- (3) 3,07,899 : three lakh seven thousand eight hundred and ninety-nine (4) 9,00,049 : nine lakh forty-nine
- (5) 5,30,735 : five lakh thirty thousand seven hundred and thirty five

□ Writing six-digit numbers in figures

(1) Eight lakh, nine thousand and forty-three : There are 8 lakhs in this number. There are no ten thousands, so we write 0 in that place. As there are 9 thousands, we write 9 in the thousands place. We write 0 in the hundreds place as there are no hundreds. Forty-three is equal to 4 tens and 3 units, so in the tens and units places we write 4 and 3 respectively. In figures : 8,09,043.

When writing numbers in figures, write the digit in the highest place first and then, in each of the next smaller places, write the proper digit from 1 to 9. Write 0, if there is no digit in that place. For example, if the number eight lakh, nine thousand and forty-three is written as '89043', it is wrong. It should be written as 8,09,043. Here, we have to write zero in the ten thousands place.

(2) Four lakh, twenty thousand, five hundred : In this figure, there aren't any thousands in the thousands place, so we write 0 in it. Since there are five hundreds, we write 5 in the hundreds place. There are no tens and units, hence, we write 0 in those places.

In figures : 4,20,500.

Problem Set 3

1. Read the numbers and write them in words.

- (1) 7,65,234 (2) 4,73,225 (3) 3,27,001 (4) 8,75,375 (5) 1,50,437
 (6) 2,03,174 (7) 6,47,851 (8) 9,00,999 (9) 5,75,010 (10) 4,03,005

2. Read the numbers and write them in figures.

- (1) One lakh thirty-five thousand eight hundred and fifty-five (2) Seven lakh twenty-seven thousand
 (3) Four lakh twenty-five thousand three hundred (4) Nine lakh nine thousand ninety-nine
 (5) Seven lakh forty-nine thousand three hundred and sixty-two (6) Eight lakh

3. Make five six-digit numbers, each time using any of the digits 0 to 9 only once.

□ Introducing seven-digit numbers

Teacher : Now we shall learn about seven-digit numbers. Suppose 10 farmers borrow ₹ 1,00,000 each from a Co-operative Bank. Then, how much is the total loan given by the bank to them ?

Ajit : We must find out what is ten times 1,00,000. That is, we multiply 1,00,000 by 10. That means we write one zero after the number to be multiplied.

Ajay : $1,00,000 \times 10 = 10,00,000$

Teacher : This becomes a seven-digit number. We read it as 'Ten lakh'. We must make one more place for the 10 lakhs to the left of the lakhs place. In western countries, the term million is used. One million is equal to ten lakhs.

Thus, ten lakh = 10,00,000.

Just as we read ten thousands and thousands together, we read ten lakhs and lakhs together. So, we read 18,35,614 as 'eighteen lakh, thirty-five thousand, six hundred and fourteen'.

Study the seven-digit numbers given below in figures and in words.

- (1) 31,25,745 : thirty-one lakh, twenty-five thousand, seven hundred and forty-five (2) 91,00,006 : ninety-one lakh and six thousand, seven hundred and forty-five
 (3) 63,00,988 : sixty-three lakh, nine hundred and eighty-eight (4) 88,00,400 : eighty-eight lakh, four hundred
 (5) seventy-two lakh and ninety-five : 72,00,095 (6) seventy lakh, two thousand, three hundred : 70,02,300

Problem Set 4

1. Read the numbers and write them in words.

- | | | | |
|---------------|----------------|----------------|----------------|
| (1) 25,79,899 | (2) 30,70,506 | (3) 45,71,504 | (4) 21,09,900 |
| (5) 43,07,854 | (6) 50,00,000 | (7) 60,00,010 | (8) 70,00,100 |
| (9) 80,01,000 | (10) 90,10,000 | (11) 91,00,000 | (12) 99,99,999 |

2. Given below are the deposits made in the Women's Co-operative Credit Societies of some districts. Read those figures.

- | | | |
|--------------------------|--------------------------|------------------------|
| Pune : ₹ 94,29,408 | Nashik : ₹ 61,07,187 | Nagpur : ₹ 46,53,570 |
| Ahmadnagar : ₹ 45,43,159 | Aurangabad : ₹ 37,01,282 | Yavatmal : ₹ 27,72,348 |
| | Sindhudurg : ₹ 58,49,651 | |

□ The expanded form of a number and the place value of digits

Teacher : Look at the place value of each of the digits in the number 27,65,043.

Digit	2	7	6	5	0	4	3
Place	Ten Lakhs	Lakhs	Ten Thousands	Thousands	Hundreds	Tens	Units
Place Value	20,00,000	7,00,000	60,000	5,000	0	40	3

Hamid : When we write the place values of the digits as an addition, we get the expanded form of the number. So, the expanded form of the number 27,65,043 is $20,00,000 + 7,00,000 + 60,000 + 5,000 + 0 + 40 + 3$.

Teacher : Now tell me the expanded form of 95,04,506.

Soni : $90,00,000 + 5,00,000 + 0 + 4,000 + 500 + 0 + 6$.

Teacher : Good! It can also be written as $90,00,000 + 5,00,000 + 4,000 + 500 + 6$.
Now write the number from the expanded form that I give you.
 $4,00,000 + 90,000 + 200$

Asha : Here, we have 4 in the lakhs place, 9 in the ten thousands place and 2 in the hundreds place. There are no digits in the ten thousands place and in the tens and units places. Hence, we write 0 in those places. Therefore, the number is 4,90,200.

Teacher : Tell me the place value of the underlined digit in the number 59,30,478.

Soni : The underlined digit is 5. The digit is in the ten lakhs place. Hence, its place value is 50,00,000 or fifty lakhs.

Problem Set 5

1. Write the place value of the underlined digit.
 (1) 78, 95,210 (2) 14, 95,210 (3) 3,52,749 (4) 50,000 (5) 89, 99,988
2. Write the numbers in their expanded form.
 (1) 56, 43, 215 (2) 70, 815 (3) 8, 35, 999 (4) 8, 88, 889 (5) 92, 32, 992
3. Write the place name and place value of each digit in the following numbers.
 (1) 35, 705 (2) 7, 82, 899 (3) 82, 74, 508
4. The expanded form of the number is given. Write the number.
 (1) 60, 000 + 4000 + 600 + 70 + 9 (2) 9, 00, 000 + 20,000 + 7000 + 800 + 5
 (3) 20,00,000 + 3,00,000 + 60,000 + 9000 + 500 + 10 + 7
 (4) 7,00,000 + 80,000 + 4000 + 500 (5) 80,00,000 + 50,000 + 1000 + 600 + 9

An interesting dice game

Prepare a table with the name of each player, as shown below.
 In front of each name, there are boxes to make seven-digit numbers.

Names	TL	L	TTH	TH	H	T	U	The number formed
Ajay	1							
Megha				3				
Pushkarni	6							
Vijay		2						

Game 1 : The first player throws the dice and writes that number in any one of the boxes in front of his/her name. You can write only one number in each box and once it is written, you cannot change its place. The other players do the same till all the boxes are filled and each one gets a seven-digit number. The one with the largest number is the winner.

Game 2 : Use the same table, but you may write the number (you get on throwing the dice) in any box in front of anyone's name. The one with the largest number is the winner.

Game 3 : The rules are the same as for game 2, but the one with the smallest number is the winner.

□ Bigger and smaller numbers

Hamid : How do we determine the smaller or bigger number when we are dealing with six- or seven-digit numbers ?

Teacher : You have learnt how to do that with five-digit numbers. The number with the bigger ten thousands digit is the bigger number. If they are the same, we look at the thousands digits to determine the smaller or bigger number.

Now, can you tell how to compare six- or seven-digit numbers ?

Hamid : Yes, I can. First, we'll look at the ten lakhs digits. If they are the same, we'll look at the digits in the lakhs place. If those are equal, we look at the ten thousands place to tell the smaller or bigger number and so on. Besides, we might be able to tell which of the numbers is bigger, just by looking at the number of digits in each number. Right ?

Teacher : Absolutely ! The number with more digits is the bigger number.

Problem Set 6

1. Write the proper symbol, '<' or '>' in the box.

(1) 5,705 15,705

(2) 22,74,705 12,74,705

(3) 35,33,302 35,32,302

(4) 99,999 9,99,999

(5) 4,80,009 4,90,008

(6) 35,80,177 35,88,172

2. Solve the problems given below.

(1) The Swayamsiddha Savings Group made 3,45,000 papads while the Swabhimani Group made 2,95,000. Which group made more papads ?

(2) Children of the Primary School in Ahmadnagar District collected 2,00,000 seeds while those in Pune District collected 3,25,000. Which children collected more seeds ?

(3) The number of people who took part in the Republic Day flag-hoisting ceremony was 2,01,306 in Pandharpur taluka and 1,97,208 in Malshiras taluka. In which taluka did a larger number of people participate ?

(4) At an exhibition, the Annapoorna Savings Group sold goods worth ₹ 5,12,345. The Nirman Group sold goods worth ₹ 4,12,900. This figure was ₹ 4,33,000 for the Srujan Group and ₹ 5,11,937 for the Savitribai Phule group.

Which group had the largest sales ?
Which group had the smallest ?

Write the sales figures in ascending order.

□ Introducing crores

99,99,999 is the biggest seven-digit number. On adding the number 1 to it, we get the smallest eight-digit number, 1,00,00,000. We read this number as ‘one crore’. The new place created to write this number is called the ‘crores’ place.

From the following examples, you can learn to read eight-digit numbers.

Number	Reading
8,45,12,706	Eight crore forty-five lakh twelve thousand seven hundred and six
5,61,63,589	Five crore sixty-one lakh sixty-three thousand five hundred and eighty-nine
6,09,04,034	Six crore nine lakh four thousand and thirty-four

Something more

On the left of the crores place are the places for ten crores, *abja*, and *ten abja* in that order. The place value of each of these is ten times the value of the one on its right. According to the Census of the year 2011, the population of our country is 1,21,01,93,422. We read this as ‘one *abja* twenty-one crore one lakh ninety-three thousand four hundred and twenty-two’.

Numbers	In words	Number of zeroes after 1
1	One	–
10	Ten	1
100	Hundred	2
1,000	One thousand	3
10,000	Ten thousand	4
1,00,000	Lakh	5
10,00,000	Ten lakh	6
1,00,00,000	Crore	7
10,00,00,000	Ten crore	8
1,00,00,00,000	<i>Abja</i>	9

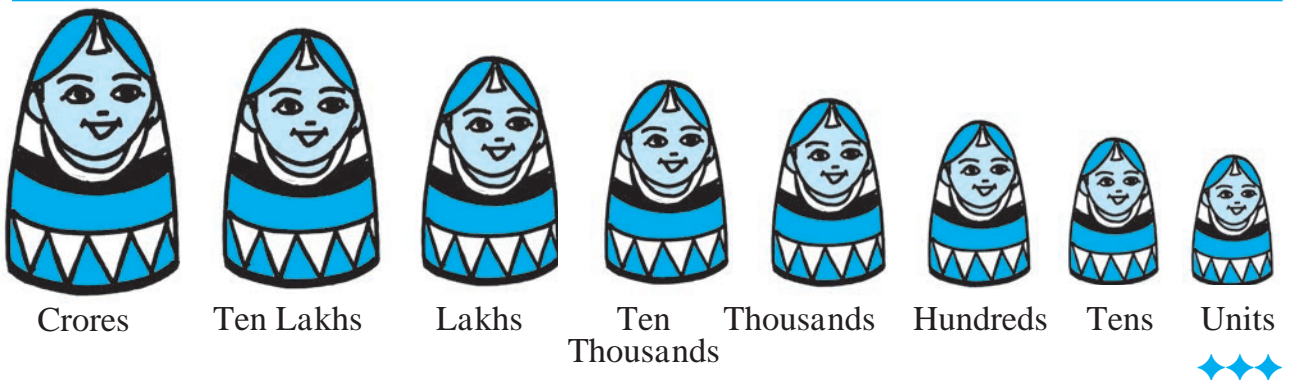

3. Addition and Subtraction



□ Addition : Revision

Study the following example.

- ◆ For the first day of a cricket match, 23,456 tickets were sold while 14,978 tickets were sold for the second day. How many tickets were sold in all?

The total number of tickets sold was 38,434.

$$\begin{array}{r} 23456 \\ + 14978 \\ \hline 38434 \end{array}$$

Problem Set 7

Add :

$$\begin{array}{r} (1) \quad 40722 \\ + \quad 13819 \\ \hline \\ \hline \end{array}$$

$$\begin{array}{r} (2) \quad 56427 \\ + \quad 10648 \\ \hline \\ \hline \end{array}$$

$$\begin{array}{r} (3) \quad 64027 \\ + \quad 28409 \\ \hline \\ \hline \end{array}$$

$$\begin{array}{r} (4) \quad 33216 \\ + \quad 28540 \\ \hline \\ \hline \end{array}$$

□ Addition of six-digit and seven-digit numbers

Last year, you have learnt to add five-digit numbers. Six- and seven-digit numbers can be added using the same method.

Study the following examples.

Add :

Example (1) $1,43,057 + 4,21,689$

L	TTh	Th	H	T	U
			1	1	
1	4	3	0	5	7
+ 4	2	1	6	8	9
5	6	4	7	4	6

Example (2) $26,42,073 + 7,39,478$

TL	L	TTh	Th	H	T	U
1		1		1	1	
2	6	4	2	0	7	3
+ 7	3	9	4	7	8	
3	3	8	1	5	5	1

Example (3) $3,12,469 + 758 + 24,092$

$$\begin{array}{r} 312469 \\ + \quad 758 \\ + \quad 24092 \\ \hline 337319 \end{array}$$

Example (4) $64 + 409 + 5,13,728$

$$\begin{array}{r} 64 \\ + \quad 409 \\ + \quad 513728 \\ \hline 514201 \end{array}$$

In the examples 3 and 4, the numbers are carried over mentally.

Problem Set 8

Add :

- | | |
|-----------------------------------|-----------------------------------|
| (1) $42,311 + 65,36,624$ | (2) $3,17,529 + 8,04,613$ |
| (3) $12,42,746 + 4,83,748$ | (4) $24,12,636 + 23,19,058$ |
| (5) $2,654 + 71,209 + 5,03,789$ | (6) $29 + 726 + 51,36,274$ |
| (7) $14,02,649 + 524 + 28,13,749$ | (8) $23,45,678 + 9,87,654$ |
| (9) $22 + 6,047 + 3,84,527$ | (10) $2,345 + 65,432 + 76,54,369$ |

Study the following word problem.

- ◆ During the polio eradication campaign, 3,17,658 children were given the polio vaccine in one District and 2,04,969 children in another. Altogether, how many children got the vaccine ?

$$\begin{array}{r}
 3\ 1\ 7\ 6\ 5\ 8 \\
 +\ 2\ 0\ 4\ 9\ 6\ 9 \\
 \hline
 5\ 2\ 2\ 6\ 2\ 7 \\
 \hline
 \end{array}$$

Altogether, 5,22,627 children got the vaccine.

Problem Set 9

Solve the following problems.

1. In a certain election, 13,47,048 women and 14,29,638 men cast their votes. How many votes were polled altogether ?
2. What will be the sum of the smallest and the largest six-digit numbers ?
3. If Surekhatai bought a tractor for ₹ 8,07,957 and a thresher for ₹ 32,609, how much money did she spend altogether ?
4. A textile mill produced 17,24,938 metres of cloth last year and 23,47,056 metres this year. What was the total production for the two years ?
5. If the Government gave ₹ 34,62,950 worth of computers and ₹ 3,26,578 worth of TV sets to the schools, what is the total amount it spent on this equipment ?

□ Subtraction : Revision

Study the following example.

- ◆ Last year , 38,796 students took a certain exam. This year the number was 47,528. How many more students took the exam this year ?

$$\begin{array}{r}
 4\ 7\ 5\ 2\ 8 \\
 -\ 3\ 8\ 7\ 9\ 6 \\
 \hline
 0\ 8\ 7\ 3\ 2 \\
 \hline
 \end{array}$$

8,732 more students took the exam this year.

Problem Set 10

Subtract :

$$\begin{array}{r} (1) \quad 64293 \\ - \quad 28547 \\ \hline \\ \hline \end{array}$$

$$\begin{array}{r} (2) \quad 37058 \\ - \quad 23469 \\ \hline \\ \hline \end{array}$$

$$\begin{array}{r} (3) \quad 71540 \\ - \quad 58628 \\ \hline \\ \hline \end{array}$$

$$\begin{array}{r} (4) \quad 50432 \\ - \quad 48647 \\ \hline \\ \hline \end{array}$$

□ Subtraction of six and seven-digit numbers

You have learnt to carry out subtractions of five-digit numbers. Using the same method, we can do subtractions of numbers with more than five digits.

Study the following examples.

Subtract :

Example (1) $65,07,843 - 9,25,586$

	14				13	
5	4	10		7	3	13
6	5	0	7	0	7	3
-	9	2	5	5	8	6
5	5	8	2	2	5	7

Example (2) $34,61,058 - 27,04,579$

3	4	6	1	0	5	8
-	2	7	0	4	5	7
0	7	5	6	4	7	9

As shown in the above example, learn to subtract by keeping the borrowed numbers in your mind without writing them down.

Subtraction by another method

Before subtracting one number from another, if we add 10 or 100 to both of them, the difference remains the same. Let us use this fact.

Example : Subtract : $724 - 376$

$$\begin{array}{r} ^{12} ^{14} \\ 7 ^2 ^4 \\ - ^3 ^7 ^6 \\ \hline ^1 ^1 \\ \hline 3 ^4 ^8 \end{array}$$

As we cannot subtract 6 from 4, we shall add a ten to both the numbers. For the upper number, we untie one tens. We add those ten units to 4 units to get 14 units.

We write the tens added to the lower number below it, in the tens place.

We subtract 6 units from 14.

Now, we cannot subtract $(7 + 1)$ i.e. 8 tens from 2 tens. So, we add one hundred to both the numbers. For the upper number, we untie the hundred and add the ten tens to 2 tens. To add the hundred to the lower number, we write it below, in the hundreds place. 12 tens minus 8 tens is 4 tens. And 7 hundreds minus $(3 + 1)$ i.e. 4 hundreds is 3 hundreds. Hence, the difference is 348.

Example (1)

4	0	5	8	2	5
–		9	8	7	6
1	1	1	1	1	
3	9	5	9	4	9

Example (2)

2	5	2	0	2	1	1
–	2	1	8	9	5	0
		1	1	1		
2	3	0	1	2	6	1

Problem Set 11

Subtract :

- (1) $8,57,513 - 4,82,256$ (2) $13,17,519 - 10,07,423$ (3) $68,34,501 - 23,57,823$
 (4) $45,43,827 - 12,05,938$ (5) $70,12,345 - 28,64,547$ (6) $38,01,213 - 37,54,648$

Study the following word problem.

In 2001, the population of a city was 21,43,567. In 2011, it was 28,09,878. By how much did the population grow?

$$\begin{array}{r} 2809878 \\ - 2143567 \\ \hline 0666311 \end{array}$$

The population grew by 6,66,311.

Problem Set 12

- Prathamesh wants to buy a laptop worth 27,450 rupees. He has 22,975 rupees. What is the amount he still needs to be able to buy the laptop?
- A company produced 44,730 scooters in a certain year and 43,150 in the next. How many more scooters did they produce in the previous year?
- In a certain city, the number of men is 16,37,856 and the number of women is 16,52,978. By how many does the number of women exceed the number of men?
- An organization decided to collect 25,00,000 rupees for a certain project. They collected 26,57,340 through donations and other kinds of aid. By how much did they exceed their target?
- Use the numbers 23,849 and 27,056 to make a subtraction problem. Solve the problem.

Mixed examples

Study the following solved examples.

Example (1) $4,13,758 + 2,09,542 - 5,16,304$

$$4,13,758 + 2,09,542 - 5,16,304 = 1,06,996$$

$$\begin{array}{r} 413758 \\ + 209542 \\ \hline 623300 \\ - 516304 \\ \hline 106996 \end{array}$$

Example (2) $345678 - 162054 + 600127$

$$345678 - 162054 + 600127 = 7,83,751$$

$$\begin{array}{r} 345678 \\ - 162054 \\ \hline 183624 \\ + 600127 \\ \hline 783751 \end{array}$$

In these examples, both operations, addition and subtraction, have to be done. They are done in the order in which they are given. In actual cases, we need to consider the specific problem to decide which operation must be done first.

Example (3) The total amount spent on building a certain house was ₹ 87,14,530. Of this amount, ₹ 24,72,615 were spent on buying the plot of land, ₹ 50,43,720 on the construction material and the rest on labour charges. What was the amount spent on labour?

Method : 1		Method : 2
$\begin{array}{r} 8714530 \rightarrow \text{Total amount spent} \\ - 2472615 \rightarrow \text{Cost of plot} \\ \hline 6241915 \rightarrow \text{Cost of material} \\ \hline \end{array}$	+ / -	$\begin{array}{r} 2472615 \text{ Cost of plot} \\ + 5043720 \text{ Cost of material} \\ \hline 7516335 \text{ Cost of plot and} \\ \text{material} \end{array}$
$\begin{array}{r} 6241915 \rightarrow \text{Cost of material and labour} \\ - 5043720 \rightarrow \text{Cost of material} \\ \hline 1198195 \rightarrow \text{Amount spent on labour} \end{array}$	+ / -	$\begin{array}{r} 8714530 \text{ Total amount spent} \\ - 7516335 \text{ Cost of plot and material} \\ \hline 1198195 \text{ Amount spent on labour} \end{array}$

Let us verify our answer.

$\begin{array}{r} 2472615 \rightarrow \text{Cost of plot} \\ + 5043720 \rightarrow \text{Cost of material} \\ + 1198195 \rightarrow \text{Amount spent on labour} \\ \hline 8714530 \rightarrow \text{Total cost} \end{array}$	<p>The sum total of all the amounts spent tallies with the given total cost. It means that our answer is correct.</p>
--	---

Problem Set 13

1. The Forest Department planted 23,078 trees of *khair*, 19,476 of *behada* besides trees of several other kinds. If the Department planted 50,000 trees altogether, how many trees were neither of *khair* nor of *behada*?
2. A city has a population of 37,04,926. If this includes 11,24,069 men and 10,96,478 women, what is the number of children in the city?
3. The management of a certain factory had 25,40,600 rupees in the labour welfare fund. From this fund, 12,37,865 rupees were used for medical expenses, 8,42,317 rupees were spent on the education of the workers' children and the remaining was put aside for a canteen. How much money was put aside for the canteen?
4. For a three-day cricket match, 13,608 tickets were sold on the first day and 8,955 on the second day. If, altogether, 36,563 tickets were sold in three days, how many were sold on the third day?



4. Multiplication and Division



□ Multiplication

Multiplying a given number by a three-digit number

Example (1) There are 754 students in a school. If one child's uniform costs 368 rupees, what will be the cost of the uniforms for all the children in the school ?

$\begin{array}{r} 754 \\ \times 368 \\ \hline 6032 \\ + 45240 \\ + 226200 \\ \hline 277472 \end{array}$	<p>----- Multiplying by 8 units</p> <p>----- Multiplying by 6 tens</p> <p>----- Multiplying by 3 hundreds</p>	<div style="border: 1px solid blue; border-radius: 50%; padding: 10px; width: fit-content; margin-bottom: 10px;"> $\begin{array}{r} 754 \\ \times 8 \\ \hline 6032 \end{array}$ </div> <div style="border: 1px solid blue; border-radius: 50%; padding: 10px; width: fit-content; margin-bottom: 10px;"> $\begin{array}{r} 754 \\ \times 60 \\ \hline 45240 \end{array}$ </div> <div style="border: 1px solid blue; border-radius: 50%; padding: 10px; width: fit-content;"> $\begin{array}{r} 754 \\ \times 300 \\ \hline 226200 \end{array}$ </div>
---	---	--

The total cost of the uniforms is ₹ 2,77,472.

Here, 754 is the multiplicand, 368 is the multiplier and 2,77,472 is the product.

Note : We could have also found out the total cost of the uniforms by taking 368 754 times and adding it up. However, it takes less time and effort to find the answer by multiplication.

Example (2) $3429 \times 507 =$ How many ?

$\begin{array}{r} 3429 \\ \times 507 \\ \hline 24003 \\ + 00000 \\ + 1714500 \\ \hline 1738503 \end{array}$	<p>----- Multiplying by 7 units</p> <p>----- Multiplying by 0 tens</p> <p>----- Multiplying by 5 hundreds</p>	<div style="border: 1px solid blue; border-radius: 50%; padding: 10px; width: fit-content; margin-bottom: 10px;"> $\begin{array}{r} 3429 \\ \times 7 \\ \hline 24003 \end{array}$ </div> <div style="border: 1px solid blue; border-radius: 50%; padding: 10px; width: fit-content; margin-bottom: 10px;"> $\begin{array}{r} 3429 \\ \times 0 \\ \hline 00000 \end{array}$ </div> <div style="border: 1px solid blue; border-radius: 50%; padding: 10px; width: fit-content;"> $\begin{array}{r} 3429 \\ \times 500 \\ \hline 1714500 \end{array}$ </div>
---	---	--

Example (3) Write a multiplication word problem using the two numbers 25,634 and 78.

Solve the problem.

A shopkeeper bought 78 TV sets for ₹25,634 each. What is their total cost ?

$$\begin{array}{r}
 25634 \text{ ----- Cost of one TV set} \\
 \times \quad 78 \text{ ----- Number of TV sets} \\
 \hline
 205072 \text{ ----- Multiplying by 8 units} \\
 + 1794380 \text{ ----- Multiplying by 7 tens} \\
 \hline
 19,99,452
 \end{array}$$

The total cost is ₹19,99,452.

$$\begin{array}{r}
 25634 \\
 \times \quad 8 \\
 \hline
 205072
 \end{array}$$

$$\begin{array}{r}
 25634 \\
 \times \quad 70 \\
 \hline
 1794380
 \end{array}$$

Make a habit of holding the carried over numbers in your mind.

Problem Set 14

1. Multiply.

- (1) 327×92 (2) 807×126 (3) 567×890 (4) 4317×824
 (5) 6092×203 (6) 1177×99 (7) 456×187 (8) 6543×79
 (9) 2306×832 (10) 6429×509 (11) $4,321 \times 678$ (12) $20,304 \times 87$

- As part of the 'Avoid Plastic' campaign, each of 745 students made 25 paper bags. What was the total number of paper bags made ?
- In a plantation, saplings of 215 medicinal trees have been planted in each of the 132 rows of trees. How many saplings are there in the plantation altogether ?
- One computer costs 27,540 rupees. How much will 18 such computers cost ?
- Under the 'Inspire Awards' scheme, 5000 rupees per student were granted for the purchase of science project materials. If 154 students in a certain taluka were covered under the scheme, find the total amount granted to that taluka.
- If a certain two-wheeler costs 53,670 rupees, how much will 35 such two-wheelers cost ?
- One hour has 3,600 seconds. How many seconds do 365 hours have ?
- Frame a multiplication word problem with the numbers 5473 and 627 and solve it.
- Find the product of the biggest three-digit number and the biggest four-digit number.
- One traveller incurs a cost of 7,650 rupees for a certain journey. What will be the cost for 26 such travellers ?

□ Pairing off objects from two groups in different ways

- (1) Ajay wants to travel light. So he took with him three shirts – one red, one green and one blue and two pairs of trousers – one white and one black. How many different ways does he have of pairing off a shirt with trousers?

Writing ‘S’ for shirt and ‘T’ for trousers, the possible different pairs are:

(Red S, Black T), (Green S, Black T), (Blue S, Black T) Altogether 6
 (Red S, White T), (Green S, White T), (Blue S, White T) different pairs.

- (2) Suresh has three balls of different colours marked A, B and C and three bats marked P, Q and R. He wishes to take only one bat and one ball to the playground. In how many ways can he pair off a ball and a bat to take with him?

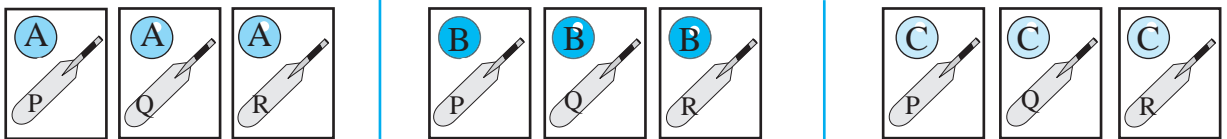

How many different pairs have been shown here?

- (3) The three friends, Sanju, John and Ali went to the fair. A shop there, had five different types of hats. Each of the boys had photos taken of himself, wearing every type of hat, in turn. Find how many photographs were taken in all.

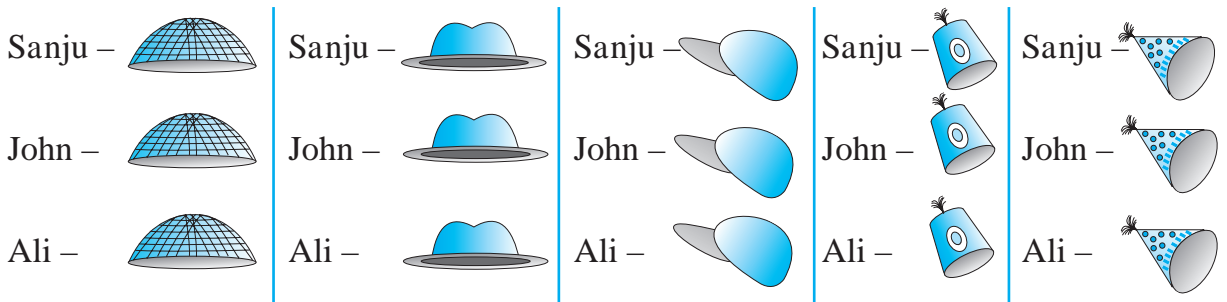

How many different pairs were formed? That is, how many photos were taken?

- ◆ Take two collections, each containing the given number of objects. Make as many different pairs as possible, taking one object from each collection every time. Thus, complete the table below.

Objects in one collection	Objects in the other collection	How many ways to form pairs?
3	2	
5	2	
2	4	
3	4	

What does this table tell us?

The number of different pairs formed by pairing off objects from two groups is equal to the product of the number of objects in the two groups.

□ Division

Teacher : You have learnt some things about division. For example, we know that division means making equal parts of a given number, or, subtracting a number repeatedly from a given number. What else do you know?

Shubha : We know that we get two divisions from one multiplication.

From $9 \times 4 = 36$, we get the divisions $36 \div 4 = 9$ and $36 \div 9 = 4$.

Teacher : Very good! Right now, there's nothing new to learn about division. Only the number of digits in the dividend and the divisor will grow. Tell me what is $354 \div 6$?

Sarang : $354 = 300 + 54$. 300 divided by six is 50. And $54 \div 6 = 9$. Hence the quotient is $50 + 9 = 59$.

Teacher : Right! Now let's learn, step by step, how to divide a four-digit number by a one-digit number. So now, divide 4925 by 7 and tell me the quotient and the remainder.

Shubha : We cannot divide 4 thousands by 7 into whole thousands. Now, 4 Th = 40 H. So let us instead take the 40 hundreds together with 9 hundreds and divide 49 hundreds. $49 \div 7 = 7$. So, everyone gets 7 hundreds. Now, we cannot divide 2T equally among 7 people. So we must write 0 in the tens place in the quotient. Then on dividing 25 by seven, we get quotient 3 and the remainder is 4. Thus, the answer is quotient 703, remainder 4.

Teacher : Very good! Now divide 7439 by 9.

Sarang : It's difficult to do this mentally. I'll write it down on paper.

The quotient is 826 and the remainder, 5.

Teacher : We use the same method to divide a four-digit number by a two-digit number. If necessary, we can prepare the table of the divisor before we start.

$$\begin{array}{r}
 0826 \\
 9 \overline{) 7439} \\
 \underline{-0} \\
 74 \\
 \underline{-72} \\
 23 \\
 \underline{-18} \\
 59 \\
 \underline{-54} \\
 5
 \end{array}$$

Study the solved examples shown below.

Example (1)

$25 \overline{) 4254}$	$25 \times 1 = 25$
$\underline{-0}$	$25 \times 2 = 50$
$\underline{42}$	$25 \times 3 = 75$
$\underline{-25}$	$25 \times 4 = 100$
$\underline{175}$	$25 \times 5 = 125$
$\underline{-175}$	$25 \times 6 = 150$
$\underline{0004}$	$25 \times 7 = 175$
$\underline{-0000}$	
$\underline{0004}$	

Quotient 170, Remainder 4

Example (2)

$32 \overline{) 9783}$	$32 \times 1 = 32$
$\underline{-0}$	$32 \times 2 = 64$
$\underline{97}$	$32 \times 3 = 96$
$\underline{-96}$	$32 \times 4 = 128$
$\underline{18}$	$32 \times 5 = 160$
$\underline{-00}$	$32 \times 6 = 192$
$\underline{183}$	
$\underline{-160}$	
$\underline{23}$	

Quotient 305, Remainder 23

Example (3) Divide. $9842 \div 45$

$$\begin{array}{r} 218 \\ 45 \overline{) 9842} \\ \underline{-90} \\ 084 \\ \underline{-45} \\ 392 \\ \underline{-360} \\ 032 \end{array}$$

We can prepare the 45 times table to do this division.

But when the divisor is a big number, we can solve the example by first guessing what the quotient will be. Let us see how to do that.

We have 0 in the thousands place in the quotient.

Now, to guess the quotient when dividing 98 by 45, look at the first digits in both – the dividend and the divisor. These are 9 and 4, respectively.

Dividing 9 by 4, we will get 2 in the quotient. Let us see if 2 times 45 can be subtracted from 98. $45 \times 2 = 90$. $90 < 98$. So, we write 2 in the hundreds place in the quotient.

Next, dividing 84 by 45 we can easily see that as $90 > 84$, we have to write 1 in the tens place in the quotient.

Now, we have to divide 392 by 45. As $3 < 4$, let us look at 39, the number formed by the first 2 digits, to guess the next digit in the quotient.

$4 \times 9 = 36$ and $36 < 39$. Let us check if the next digit can be 9. $45 \times 9 = 405$ and $405 > 392$. Therefore, 9 cannot be the next digit in the quotient.

Let us check for 8. $45 \times 8 = 360$. $360 < 392$. So, we write 8 in the units place of the quotient.

We subtract 8×45 from 392 and complete the division.

The quotient is 218 and the remainder, 32.

Example (4) If 35 kilograms of wheat cost 910 rupees, what is the rate of wheat per kg?

Weight of wheat in kg \times rate of wheat per kg = cost of wheat

Hence, $35 \times$ rate per kg = 910

Therefore, when we divide 910 by 35, we will get the per kg rate of wheat.

The rate per kilogram of wheat is 26 rupees.

$$\begin{array}{r} 26 \\ 35 \overline{) 910} \\ \underline{-70} \\ 210 \\ \underline{-210} \\ 000 \end{array}$$

Problem Set 15

1. Solve the following and write the quotient and remainder.

(1) $1284 \div 32$

(2) $5586 \div 87$

(3) $1207 \div 27$

(4) $8543 \div 41$

(5) $2304 \div 43$

(6) $56,741 \div 26$

2. How many hours will it take to travel 336 km at a speed of 48 km per hour?

3. Girija needed 35 cartons to pack 1400 books. There are an equal number of books in every carton. How many books did she pack into each carton?

4. The contribution for a picnic was 65 rupees each. Altogether, 2925 rupees were collected. How many had paid for the picnic?

5. Which number, on being multiplied by 56, gives a product of 9688?

- If 48 sheets are required for making one notebook, how many notebooks at the most will 5880 sheets make and how many sheets will be left over?
- What will the quotient be when the smallest five-digit number is divided by the smallest four-digit number?

Mixed examples

◆ A farmer brought 140 trays of chilli seedlings. Each tray had 24 seedlings. He planted all the seedlings in his field, putting 32 in a row. How many rows of chillies did he plant?

Let us find out the total number of seedlings when there were 24 seedlings in each of the 140 trays. We shall multiply 140 and 24.

Total number of seedlings 3,360.

To find out how many rows were planted with 32 seedlings in each row, we shall divide 3,360 by 32.

The quotient is 105.

Therefore, the number of rows is 105.

Carry out the multiplication of 105×32 and verify your answer.

$$\begin{array}{r} 140 \\ \times 24 \\ \hline 560 \\ + 2800 \\ \hline 3360 \end{array}$$

$$\begin{array}{r} 105 \\ 32 \overline{) 3360} \\ \underline{- 32} \\ 016 \\ \underline{- 00} \\ 160 \\ \underline{- 160} \\ 000 \end{array}$$

Problem Set 16

- From a total of 10,000 rupees, Anna donated 7,000 rupees to a school. The remaining amount was to be divided equally among six students as the 'all-round student' prize. What was the amount of each prize?
- An amount of 260 rupees each was collected from 50 students for a picnic. If 11,450 rupees were spent for the picnic, what is the amount left over?
- A shopkeeper bought a sack of 50kg of sugar for 1750 rupees. As the price of sugar fell, he had to sell it at the rate of 32 rupees per kilo. How much less money did he get than he had spent?
- A shopkeeper bought 7 pressure cookers at the rate of 1870 rupees per cooker. He sold them all for a total of 14,230 rupees. Did he get less or more money than he had spent?
- Fourteen families in a Society together bought 8 sacks of wheat, each weighing 98 kilos. If they shared all the wheat equally, what was the share of each family?
- The capacity of an overhead water tank is 3000 litres. There are 16 families living in this building. If each family uses 225 litres every day, will the tank filled to capacity be enough for all the families? If not, what will the daily shortfall be?



5. Fractions

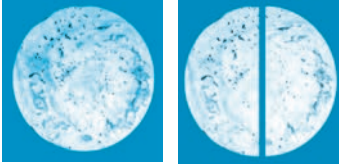

□ Equivalent fractions

◆  If one bhakari is divided equally between two people, each one will get **half** a bhakari. The fraction half is written as $\frac{1}{2}$. Here 1 is the numerator and 2 is the denominator.

◆ One bhakari was divided into four equal parts. Two of the parts were given away. This is shown as $\frac{2}{4}$. Here, 2 is the numerator and 4, the denominator. This, too, means that **half** a bhakari was given.

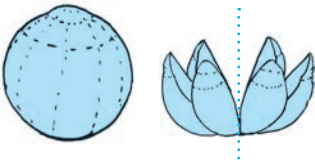

◆  Six equal parts were made of one melon. They were shared equally by two people. It means that the part that each one got was $\frac{3}{6}$. Each one actually got **half** the melon. Thus, $\frac{3}{6}$ also shows the fraction 'one half'.

In the three examples above, the fraction 'half' has been shown by $\frac{1}{2}$, $\frac{2}{4}$, $\frac{3}{6}$ respectively.

It means that the value of all three fractions is the same. This is written as $\frac{1}{2} = \frac{2}{4} = \frac{3}{6}$. Such fractions of equal value are called **equivalent fractions**.

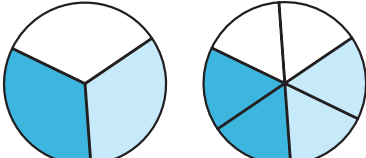
◆  Look at the coloured parts of the two equal circles shown alongside. One circle is divided into 3 equal parts and two of them are coloured. That is, the coloured part is $\frac{2}{3}$ of the circle.

The other circle of the same size is divided into six equal parts and 4 of them are coloured. That is, $\frac{4}{6}$ of the whole circle is coloured. However, we see that the coloured parts of the two circles are equal. Therefore, $\frac{2}{3} = \frac{4}{6}$.

Thus, $\frac{2}{3}$ and $\frac{4}{6}$ are equivalent fractions.

□ Obtaining equivalent fractions

◆  Two of the 5 equal parts in the figure are coloured. The coloured part is $\frac{2}{5}$ of the whole figure.

When two lines are drawn across the same figure, it gets divided into 15 equal parts. So, now, the fraction that shows the coloured part is $\frac{6}{15}$.

However, the coloured part has not changed. Therefore, we see that $\frac{2}{5} = \frac{6}{15}$.

Teacher : Do you see any special connection between the numerators and denominators of the fractions $\frac{2}{5}$ and $\frac{6}{15}$?

Sonu : Three times 2 is 6 and three times 5 is fifteen.

Teacher : We have also seen that $\frac{1}{2} = \frac{2}{4}$, $\frac{1}{2} = \frac{3}{6}$ and $\frac{2}{3} = \frac{4}{6}$. In two equivalent fractions, the numerator of one fraction is as many times the numerator of the other as the denominator of one is of the denominator of the other.

When the numerator and denominator of a fraction are multiplied by the same non-zero number, we get a fraction that is equivalent to the given fraction.

Nandu : Can I get an equivalent fraction by dividing the numerator and denominator by the same number ?

Teacher : Of course ! If the numerator and denominator have a common divisor, then the fraction obtained on actually dividing them by that divisor is equivalent to the given fraction. The numerator and denominator of the fraction $\frac{6}{15}$ can be divided by 3. On doing this division, we get the fraction $\frac{2}{5}$.

It means that $\frac{6}{15} = \frac{2}{5}$.

If the numerator and denominator have a common divisor then the fraction we get on dividing them by that divisor is equivalent to the given fraction.

Teacher : Divide the numerator and denominator of $\frac{6}{12}$ by the same number to find an equivalent fraction.

Sonu obtained this fraction $\frac{6}{12} = \frac{6 \div 2}{12 \div 2} = \frac{3}{6}$

Minu obtained this fraction $\frac{6}{12} = \frac{6 \div 3}{12 \div 3} = \frac{2}{4}$

Nandu : 6 and 12 can also be divided by 6. Will that do ?

Teacher : Sure. $\frac{6}{12} = \frac{6 \div 6}{12 \div 6} = \frac{1}{2}$.

Remember that the fractions we get by dividing $\frac{6}{12}$ by 2 or 3 or 6 are all equivalent to $\frac{6}{12}$. That is $\frac{6}{12} = \frac{3}{6} = \frac{2}{4} = \frac{1}{2}$.

Example (1) Find a fraction with denominator 30 which is equivalent to $\frac{5}{6}$.

$\frac{5}{6} = \frac{\square}{30}$. We must find the right number for the box.

Here, 5 times the denominator 6 is 30. What is five times the numerator 5 ?

$\frac{5}{6} = \frac{5 \times 5}{6 \times 5} = \frac{25}{30}$. Hence, the fraction $\frac{25}{30}$ with denominator 30 is equivalent to $\frac{5}{6}$.

Example (2) Find a fraction equivalent to $\frac{15}{40}$ but with denominator 8.

$$\frac{15}{40} = \frac{\square}{8}. \text{ We must find the number for the box.}$$

40 divided by 5 is 8.

So, we will get the number for the box by dividing 15 by 5. $15 \div 5 = 3$.

$$\text{Therefore, } \frac{15}{40} = \frac{\boxed{3}}{8}$$

Thus, the fraction $\frac{3}{8}$ is equivalent to the fraction $\frac{15}{40}$.

Problem Set 17

1. Write the proper number in the box.

$$(1) \frac{1}{2} = \frac{\square}{20}$$

$$(2) \frac{3}{4} = \frac{15}{\square}$$

$$(3) \frac{9}{11} = \frac{18}{\square}$$

$$(4) \frac{10}{40} = \frac{\square}{8}$$

$$(5) \frac{14}{26} = \frac{\square}{13}$$

$$(6) \frac{\square}{3} = \frac{4}{6}$$

$$(7) \frac{1}{\square} = \frac{4}{20}$$

$$(8) \frac{\square}{5} = \frac{10}{25}$$

2. Find an equivalent fraction with denominator 18, for each of the following fractions.

$$\frac{1}{2}, \frac{2}{3}, \frac{4}{6}, \frac{2}{9}, \frac{7}{9}, \frac{5}{3}$$

3. Find an equivalent fraction with denominator 5, for each of the following fractions.

$$\frac{6}{15}, \frac{10}{25}, \frac{12}{30}, \frac{6}{10}, \frac{21}{35}$$

4. From the fractions given below, pair off the equivalent fractions.

$$\frac{2}{3}, \frac{5}{7}, \frac{5}{11}, \frac{7}{9}, \frac{14}{18}, \frac{15}{33}, \frac{18}{27}, \frac{10}{14}$$

5. Find two equivalent fractions for each of the following fractions.

$$\frac{7}{9}, \frac{4}{5}, \frac{3}{11}$$

□ Like fractions and unlike fractions

Fractions such as $\frac{1}{7}, \frac{4}{7}, \frac{6}{7}$ whose denominators are equal, are called 'like fractions'.

Fractions such as $\frac{1}{3}, \frac{4}{8}, \frac{9}{11}$ which have different denominators are called 'unlike fractions'.

□ Converting unlike fractions into like fractions

Example (1) Convert $\frac{5}{6}$ and $\frac{7}{9}$ into like fractions.

Here, we must find a common multiple for the numbers 6 and 9.

Multiples of 6 : 6, 12, 18, 24, 30, 36,

Multiples of 9 : 9, 18, 27, 36, 45

Here, the number 18 is a multiple of both 6 and 9. So, let us make 18 the denominator of both fractions.

$$\frac{5}{6} = \frac{5 \times 3}{6 \times 3} = \frac{15}{18} \quad \frac{7}{9} = \frac{7 \times 2}{9 \times 2} = \frac{14}{18}$$

Thus, $\frac{15}{18}$ and $\frac{14}{18}$ are like fractions, respectively equivalent to $\frac{5}{6}$ and $\frac{7}{9}$.

Here, 18 is a multiple of both 6 and 9. We could also choose numbers like 36 and 54 as the common denominators.

Example (2) Convert $\frac{4}{8}$ and $\frac{5}{16}$ into like fractions.

As 16 is twice 8, it is easy to make 16 the common denominator.

$$\frac{4}{8} = \frac{4 \times 2}{8 \times 2} = \frac{8}{16}. \text{ Thus, } \frac{8}{16} \text{ and } \frac{5}{16} \text{ are the required like fractions.}$$

Example (3) Find a common denominator for $\frac{4}{7}$ and $\frac{3}{4}$.

The number 28 is a multiple of both 7 and 4. So, make 28 the common denominator.

$$\frac{4}{7} = \frac{4 \times 4}{7 \times 4} = \frac{16}{28}, \quad \frac{3}{4} = \frac{3 \times 7}{4 \times 7} = \frac{21}{28}. \text{ Therefore, } \frac{16}{28} \text{ and } \frac{21}{28} \text{ are the required like fractions.}$$

Problem Set 18

Convert the given fractions into like fractions.

(1) $\frac{3}{4}, \frac{5}{8}$

(2) $\frac{3}{5}, \frac{3}{7}$

(3) $\frac{4}{5}, \frac{3}{10}$

(4) $\frac{2}{9}, \frac{1}{6}$

(5) $\frac{1}{4}, \frac{2}{3}$

(6) $\frac{5}{6}, \frac{4}{5}$

(7) $\frac{3}{8}, \frac{1}{6}$

(8) $\frac{1}{6}, \frac{4}{9}$

Comparing like fractions

Example (1) A strip was divided into 5 equal parts. It means that each part is $\frac{1}{5}$. The

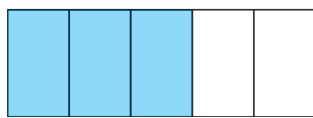

coloured part is $\frac{3}{5} = \frac{1}{5} + \frac{1}{5} + \frac{1}{5}$.

The white part is $\frac{2}{5} = \frac{1}{5} + \frac{1}{5}$. The coloured part is bigger than

the white part. This tells us that $\frac{3}{5}$ is greater than $\frac{2}{5}$. This is written as $\frac{3}{5} > \frac{2}{5}$.

Example (2) This strip is divided into 8 equal parts. 3 of the parts have one colour and 4

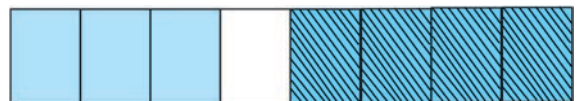

have another colour. Here, $\frac{3}{8} < \frac{4}{8}$.

In like fractions, the fraction with the greater numerator is the greater fraction.

□ Comparing fractions with equal numerators

You have learnt that the value of fractions with numerator 1 decreases as the denominator increases.

Even if the numerator is not 1, the same rule applies so long as all the fractions have a common numerator. For example, look at the figures below. All the strips in the figure are alike.



The figure shows that $\frac{2}{3} > \frac{2}{4} > \frac{2}{5}$.

Of two fractions with equal numerators, the fraction with the greater denominator is the smaller fraction.

□ Comparing unlike fractions

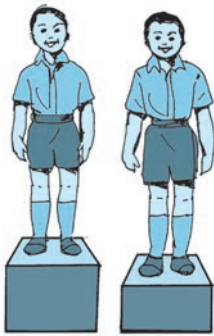

Teacher : Suppose we have to compare the unlike fractions $\frac{3}{5}$ and $\frac{4}{7}$. Let us take an example to see how this is done. These two boys are standing on two blocks. How do we decide who is taller?

Sonu : But the height of the blocks is not the same. If both blocks are of the same height, it is easy to tell who is taller.

Nandu : Now that they are on blocks of equal height, we see that the boy on the right is taller.

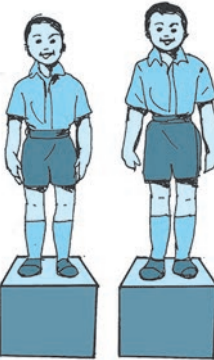

Teacher : The height of the boys can be compared when they stand at the same height. Similarly, if fractions have the same denominators, their numerators decide which fraction is bigger.

Nandu : Got it! Let's obtain the same denominators for both fractions.

Sonu : 5×7 can be divided by both 5 and 7. So, 35 can be the common denominator.

$$\frac{3}{5} = \frac{3 \times 7}{5 \times 7} = \frac{21}{35} \quad \frac{4}{7} = \frac{4 \times 5}{7 \times 5} = \frac{20}{35}$$

$$\frac{21}{35} > \frac{20}{35} \quad \text{Therefore, } \frac{3}{5} > \frac{4}{7}$$

To compare unlike fractions, we convert them into their equivalent fractions so that their denominators are the same.

Problem Set 19

Write the proper symbol from $<$, $>$, or $=$ in the box.

- | | | | |
|--|--|--|---|
| (1) $\frac{3}{7}$ <input type="text"/> $\frac{3}{7}$ | (2) $\frac{3}{8}$ <input type="text"/> $\frac{2}{8}$ | (3) $\frac{2}{11}$ <input type="text"/> $\frac{10}{11}$ | (4) $\frac{5}{15}$ <input type="text"/> $\frac{10}{30}$ |
| (5) $\frac{5}{8}$ <input type="text"/> $\frac{5}{9}$ | (6) $\frac{4}{7}$ <input type="text"/> $\frac{4}{11}$ | (7) $\frac{10}{11}$ <input type="text"/> $\frac{10}{13}$ | (8) $\frac{1}{5}$ <input type="text"/> $\frac{1}{9}$ |
| (9) $\frac{5}{6}$ <input type="text"/> $\frac{1}{8}$ | (10) $\frac{5}{12}$ <input type="text"/> $\frac{1}{6}$ | (11) $\frac{7}{8}$ <input type="text"/> $\frac{14}{16}$ | (12) $\frac{4}{9}$ <input type="text"/> $\frac{4}{9}$ |
| (13) $\frac{5}{18}$ <input type="text"/> $\frac{1}{9}$ | (14) $\frac{2}{3}$ <input type="text"/> $\frac{4}{7}$ | (15) $\frac{3}{7}$ <input type="text"/> $\frac{5}{9}$ | (16) $\frac{4}{11}$ <input type="text"/> $\frac{1}{5}$ |

□ Addition of like fractions

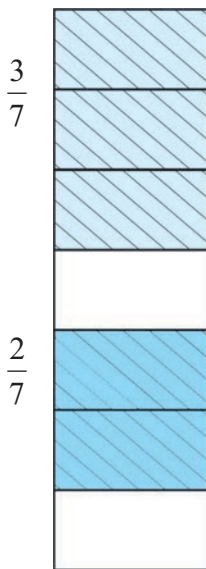

Example (1) $\frac{3}{7} + \frac{2}{7} = ?$

Let us divide a strip into 7 equal parts. We shall colour 3 parts with one colour and 2 parts with another.

The part with one colour is $\frac{3}{7}$, and that with the other colour is $\frac{2}{7}$.

The total coloured part is shown by the fraction $\frac{5}{7}$.

It means that, $\frac{3}{7} + \frac{2}{7} = \frac{3+2}{7} = \frac{5}{7}$.

Example (2) Add : $\frac{3}{8} + \frac{2}{8} + \frac{1}{8}$.

The total coloured part is $\frac{3}{8} + \frac{2}{8} + \frac{1}{8} = \frac{3+2+1}{8} = \frac{6}{8}$.

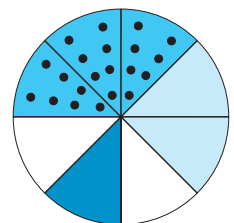

When adding like fractions, we add the numerators of the two fractions and write the denominator as it is.

Example (3) Add : $\frac{2}{6} + \frac{4}{6}$

$\frac{2}{6} + \frac{4}{6} = \frac{2+4}{6} = \frac{6}{6}$. However, we know that $\frac{6}{6}$ means that all 6 of the 6 equal parts are taken. That is, 1 whole figure is taken. Therefore, $\frac{6}{6} = 1$. Note that :

If the numerator and denominator of a fraction are equal, the fraction is equal to one.

That is why, $\frac{7}{7} = 1$; $\frac{10}{10} = 1$; $\frac{2}{5} + \frac{3}{5} = \frac{2+3}{5} = \frac{5}{5} = 1$.

Remember that, if we do not divide a figure into parts, but keep it whole, it can also be written as 1.

This tells us that $1 = \frac{1}{1} = \frac{2}{2} = \frac{3}{3}$ and so on.

You also know that if the numerator and denominator of a fraction have a common divisor, then the fraction obtained by dividing them by that divisor is equivalent to the given fraction.

$$\frac{5}{5} = \frac{5 \div 5}{5 \div 5} = \frac{1}{1} = 1$$

Problem Set 20

1. Add :

(1) $\frac{1}{5} + \frac{3}{5}$

(2) $\frac{2}{7} + \frac{4}{7}$

(3) $\frac{7}{12} + \frac{2}{12}$

(4) $\frac{2}{9} + \frac{7}{9}$

(5) $\frac{3}{15} + \frac{4}{15}$

(6) $\frac{2}{7} + \frac{1}{7} + \frac{3}{7}$

(7) $\frac{2}{10} + \frac{4}{10} + \frac{3}{10}$

(8) $\frac{4}{9} + \frac{1}{9}$

(9) $\frac{5}{8} + \frac{3}{8}$

2. Mother gave $\frac{3}{8}$ of one guava to Meena and $\frac{2}{8}$ of the guava to Geeta.

What part of the guava did she give them altogether?

3. The girls of Std V cleaned $\frac{3}{4}$ of a field while the boys cleaned $\frac{1}{4}$. What part of the field was cleaned altogether?

Subtraction of like fractions



A figure is divided into 5 equal parts and 4 of them are coloured. That is, $\frac{4}{5}$ part of the figure is coloured.

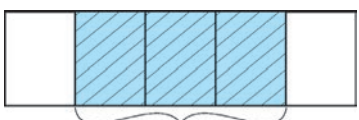

$\frac{1}{5}$

$\frac{3}{5}$

Now, we remove the colour from one of the coloured parts. That is, we subtract $\frac{1}{5}$ from $\frac{4}{5}$. The remaining coloured part is $\frac{3}{5}$. Therefore, $\frac{4}{5} - \frac{1}{5} = \frac{4-1}{5} = \frac{3}{5}$

When subtracting a fraction from another like fraction, we write the difference between the numerators in the numerator and the common denominator in the denominator.

Example (1) Subtract : $\frac{7}{13} - \frac{5}{13}$

These two fractions have a common denominator. So, we shall subtract the second numerator from the first and write the denominator as it is.

$$\frac{7}{13} - \frac{5}{13} = \frac{7-5}{13} = \frac{2}{13}$$

Example (2) If Raju got $\frac{5}{12}$ part of a sugarcane and Sanju got $\frac{3}{12}$ part, how much was the extra part that Raju got?

To find out the difference, we must subtract.

$$\frac{5}{12} - \frac{3}{12} = \frac{5-3}{12} = \frac{2}{12} . \text{ Thus, Raju got } \frac{2}{12} \text{ extra.}$$

Problem Set 21

1. Subtract :

(1) $\frac{5}{7} - \frac{1}{7}$

(2) $\frac{5}{8} - \frac{3}{8}$

(3) $\frac{7}{9} - \frac{2}{9}$

(4) $\frac{8}{11} - \frac{5}{11}$

(5) $\frac{9}{13} - \frac{4}{13}$

(6) $\frac{7}{10} - \frac{3}{10}$

(7) $\frac{9}{12} - \frac{2}{12}$

(8) $\frac{10}{15} - \frac{3}{15}$

2. $\frac{7}{10}$ of a wall is to be painted. Ramu has painted $\frac{4}{10}$ of it. How much more needs to be painted?

□ Addition and subtraction of unlike fractions

Example (1) Add : $\frac{2}{3} + \frac{1}{6}$



First let us show the fraction $\frac{2}{3}$ by colouring two of the three equal parts on a strip.

You have learnt to add and to subtract fractions with common denominators. Here, we have to add the fraction $\frac{1}{6}$ to the fraction $\frac{2}{3}$.



So let us divide each part on this strip into two equal parts. $\frac{4}{6}$ is a fraction equivalent to $\frac{2}{3}$. Now, as $\frac{1}{6}$ is to be added

to $\frac{2}{3}$ i.e. to $\frac{4}{6}$, we shall colour one more of the six parts on the strip. Now, the total coloured part is $\frac{5}{6}$.

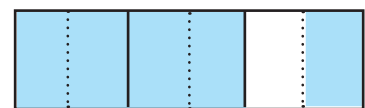

Therefore, $\frac{2}{3} + \frac{1}{6} = \frac{4+1}{6} = \frac{5}{6}$.

That is, $\frac{2}{3} + \frac{1}{6} = \frac{5}{6}$.

Example (2) Add : $\frac{1}{2} + \frac{2}{5}$

Here, the smallest common multiple of the two denominators is 10. So, we shall change the denominator of both fractions to 10.

$$\begin{aligned}\frac{1}{2} + \frac{2}{5} &= \frac{1 \times 5}{2 \times 5} + \frac{2 \times 2}{5 \times 2} \\ &= \frac{5}{10} + \frac{4}{10} \\ &= \frac{5+4}{10} = \frac{9}{10}\end{aligned}$$

Example (3) Add : $\frac{3}{8} + \frac{1}{16}$

Here, 16 is twice 8. So, we shall change the denominator of both fractions to 16.

$$\begin{aligned}\frac{3}{8} + \frac{1}{16} &= \frac{3 \times 2}{8 \times 2} + \frac{1}{16} \\ &= \frac{6}{16} + \frac{1}{16} \\ &= \frac{6+1}{16} = \frac{7}{16}\end{aligned}$$

Example (4) Subtract : $\frac{3}{4} - \frac{5}{8}$

Let us make 8 the common denominator of the given fractions.

$$\begin{aligned}\frac{3}{4} - \frac{5}{8} &= \frac{3 \times 2}{4 \times 2} - \frac{5}{8} \\ &= \frac{6}{8} - \frac{5}{8} \\ &= \frac{6-5}{8} \\ &= \frac{1}{8}\end{aligned}$$

Example (5) Subtract : $\frac{4}{5} - \frac{2}{3}$

The smallest common multiple of the denominators is 15. So, we shall change the denominator of both fractions to 15.

$$\begin{aligned}\frac{4}{5} - \frac{2}{3} &= \frac{4 \times 3}{5 \times 3} - \frac{2 \times 5}{3 \times 5} \\ &= \frac{12}{15} - \frac{10}{15} \\ &= \frac{12-10}{15} \\ &= \frac{2}{15}\end{aligned}$$

Problem Set 22

1. Add :

(1) $\frac{1}{8} + \frac{3}{4}$ (2) $\frac{2}{21} + \frac{3}{7}$ (3) $\frac{2}{5} + \frac{1}{3}$ (4) $\frac{2}{7} + \frac{1}{2}$ (5) $\frac{3}{9} + \frac{3}{5}$

2. Subtract :

(1) $\frac{3}{10} - \frac{1}{20}$ (2) $\frac{3}{4} - \frac{1}{2}$ (3) $\frac{6}{14} - \frac{2}{7}$ (4) $\frac{4}{6} - \frac{3}{5}$ (5) $\frac{2}{7} - \frac{1}{4}$

□ A fraction of a collection and a multiple of a fraction

◆ $\frac{1}{4}$ of a collection of 20 dots

$\frac{1}{4}$ of 20 = 5
 $20 \div 4 = 5$

◆ $\frac{1}{2}$ of a collection of 20 dots

$\frac{1}{2}$ of 20 = 10
 $20 \div 2 = 10$

◆ $\frac{3}{4}$ of a collection of 20 dots

$\frac{3}{4} = \frac{1}{4} + \frac{1}{4} + \frac{1}{4}$
 $\frac{3}{4}$ of 20 is three $\frac{1}{4}$ parts of 20; that is, 15 dots
 $20 \div 4 = 5, 5 \times 3 = 15$

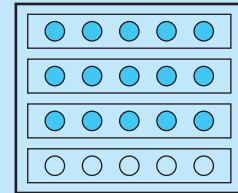

◆ Twice 5 is 10

2 rows of
5 balls each
 $5 \times 2 = 10$
 Twice 5 is 10

◆ $\frac{1}{2}$ times 10

$\frac{1}{2}$ of 10 = 5
 $\frac{1}{2}$ times 10 = 5

◆ Thrice 5

Total balls 15
 Thrice 5 = 15
 That is, $5 \times 3 = 15$

◆ $\frac{1}{3}$ times 15

$\frac{1}{3}$ times 15
 Hence, $15 \times \frac{1}{3} = 5$
 $15 \div 3 = 5$

◆ $\frac{2}{3}$ times 15

To get $\frac{2}{3}$ times 15 is to find $\frac{1}{3}$ times 15 and take it twice.

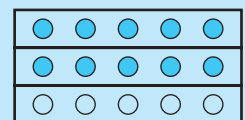

◆ Meena has 5 rupees. Tina has twice as many rupees. That is, Tina has $5 \times 2 = 10$ rupees. Meena has half as many rupees as Tina, that is, $\frac{1}{2}$ of 10, or, 5 rupees.

◆ Ramu has to travel a distance of 20 km. If he has travelled $\frac{4}{5}$ of the distance by car, how many kilometres did he travel by car?

$\frac{4}{5}$ of 20 km is $20 \times \frac{4}{5}$. So, we take $\frac{1}{5}$ of 20, 4 times.

$\frac{1}{5}$ of 20 = 4. 4 times 4 is $4 \times 4 = 16$.

It means that $20 \times \frac{4}{5} = 16$.

Ramu travelled a distance of 16 kilometres by car.

Problem Set 23

1. What is $\frac{1}{3}$ of each of the collections given below?

(1) 15 pencils (2) 21 balloons (3) 9 children (4) 18 books

2. What is $\frac{1}{5}$ of each of the following?

(1) 20 rupees (2) 30 km (3) 15 litres (4) 25 cm

3. Find the part of each of the following numbers equal to the given fraction.

(1) $\frac{2}{3}$ of 30 (2) $\frac{7}{11}$ of 22 (3) $\frac{3}{8}$ of 64 (4) $\frac{5}{13}$ of 65

Mixed fractions

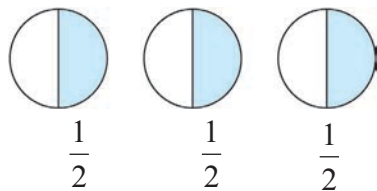

Half of each of the three circles is coloured. That is, 3 parts, each equal to $\frac{1}{2}$ of the circle, are coloured.

The coloured part is $\frac{1}{2} + \frac{1}{2} + \frac{1}{2}$, that is, $\frac{3}{2}$ or $1 + \frac{1}{2}$.

$1 + \frac{1}{2}$ is written as $1 \frac{1}{2}$. $1 \frac{1}{2}$ is read as 'one and one upon two'.

In the fraction $1 \frac{1}{2}$, 1 is the integer part and $\frac{1}{2}$ is the fraction part. Hence, such fractions are called **mixed fractions** or **mixed numbers**. $2 \frac{1}{4}$, $3 \frac{2}{5}$, $7 \frac{4}{9}$ are all mixed fractions.

Fractions in which the numerator is greater than the denominator are called **improper fractions**.

$\frac{3}{2}$, $\frac{5}{3}$ are improper fractions. We can convert improper fractions into mixed fractions.

For example, $\frac{3}{2} = \frac{2+1}{2} = \frac{2}{2} + \frac{1}{2} = 1 + \frac{1}{2} = 1 \frac{1}{2}$

Activities

1. Colour the Hats.



In the picture alongside :

Colour $\frac{1}{3}$ of the hats red.

Colour $\frac{3}{5}$ of the hats blue.

How many hats have you coloured red ?

How many hats have you coloured blue ?

How many are still not coloured ?

2. Make a Magic Spinner.

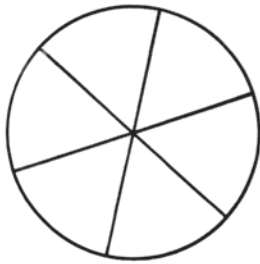

Take a white cardboard disc. As shown in the figure, divide it into six equal parts.

Colour the parts red, orange, yellow, green, blue and violet.

Make a small hole at the centre of the disc and fix a pointed stick in the hole.

Your magic spinner is ready.

What fraction of the disc is each of the coloured parts ?

Give the disc a strong tug to make it turn fast. What colour does it appear to be now ?

The Clever Poet

There was a king who had a great love for literature. A certain poet knew that if the king read a good poem it made him very happy. Then the king would give the poet an award. Once, the poet composed a good poem. He thought if he showed it to the king, he would win a prize. So, he went to the king's palace. But, it was not easy to meet the king. You had to pass a number of gates and guards. The first guard asked the poet why he wanted to meet the king. So, the poet told him the reason. Seeing the chance of getting a share of the award, the guard demanded, 'You must give me $\frac{1}{10}$ of your prize. Only then will I let you go in.' The poet could do nothing but agree. The second guard stopped him and said, 'I will let you go in only if you promise me $\frac{2}{5}$ of your prize.' The third guard, too, was a greedy man. He said, 'I will not let you go, unless you promise me $\frac{1}{4}$ of your prize.' The king's palace was just a little distance away. Now, the poet told the guard, 'Why only $\frac{1}{4}$, I shall give you half the prize!' The guard was pleased and let him in.

The king liked the poem. He asked the poet, 'What is the prize you want?' 'I shall be happy if Your Majesty awards me 100 lashes of the whip.' The king was surprised. 'Are you out of your mind!' he exclaimed. 'I have never met anyone so crazy as to ask for a whipping!'

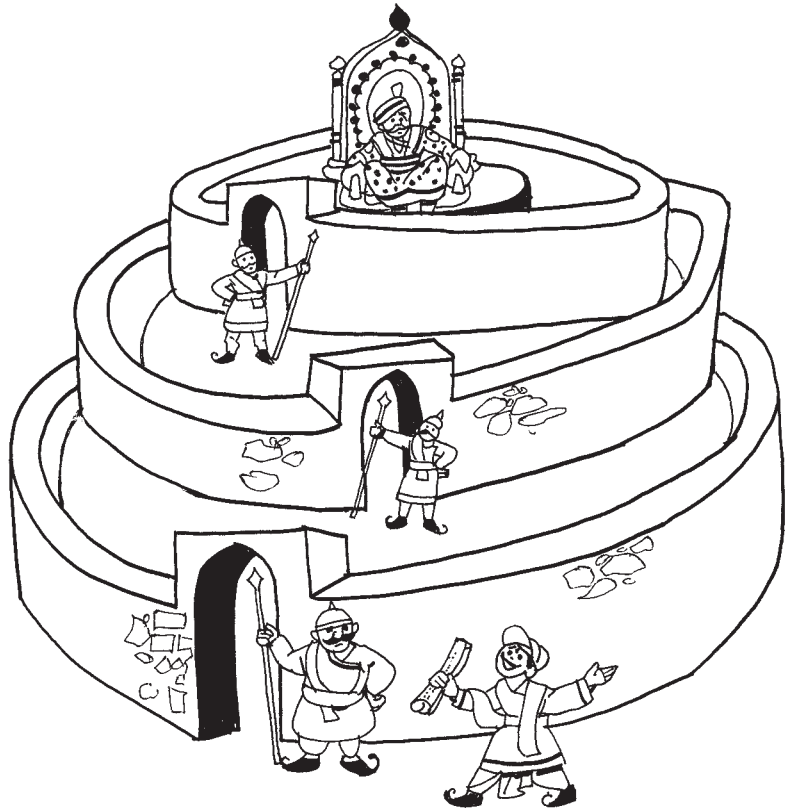

'Your Majesty, if you wish to know the reason, the three palace guards must be called here.' When the guards came, the poet explained, 'Your Majesty, all of them have a share in the 100 lashes that you have awarded to me. Each of them has fixed his own share of the prize I get. The first guard must get $\frac{1}{10}$ of the award, that is, lashes. The second must get $\frac{2}{5}$, which is , and the third must get half the award, that is, lashes!' The king could now see how greedy the guards were and how clever the poet was. He saw to it that each guard got the punishment he deserved. He gave the poet a prize for his poem. He also gave him an extra 100 gold coins for exposing the greed of the guards.

What was the clever idea of the poet which the king appreciated so much?





6. Angles

Revision

This is a right angle.	This is an acute angle.	This is an obtuse angle.

Look at the clocks given below. Write whether the hands make a right angle, an acute angle or an obtuse angle in the box below.

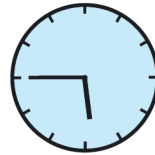
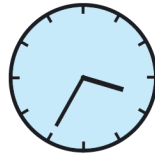
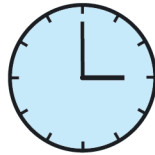

Components of angles, naming an angle

Teacher : Monu, what does the diagram given here show?

Monu : The diagram shows an angle. Sir, do angles have names?

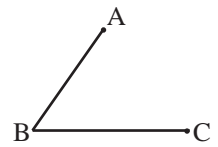

Teacher : Yes, angles have names. Can you see the lines in the diagram? Tell me their names.

Monu : This diagram has two lines, BA and BC.

Teacher : Which is the common point between the two lines?

Monu : The common point is B.

Teacher : These two lines join together to form an angle. The common point B is called the 'vertex'. BA and BC are the 'arms' of the angle.

Monu : Then, Sir, what is the name of the angle?

Teacher : An angle is named by three letters. The letter in the middle represents the vertex of the angle.

Monu : That means, the name of the angle is ABC. Is that right?

Teacher : Yes. While naming the angle, we say 'angle ABC'.

Monu : Sir, instead of 'angle ABC', can we say 'angle CBA'?

Teacher : Yes, we can call the angle ‘angle ABC’ or ‘angle CBA’. Both are correct. The symbol ‘ \angle ’ represents the word ‘angle’. We use this symbol to write ‘angle ABC’ as ‘ $\angle ABC$ ’.

Problem Set 24

Complete the following table.

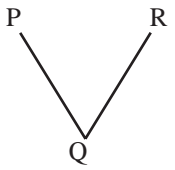
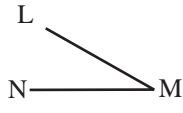
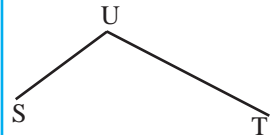
Diagram	Name of the angle	Vertex	Arms of an angle
	‘ $\angle PQR$ ’ or ‘ $\angle RQP$ ’	Q	QP and QR
			
			

The protractor

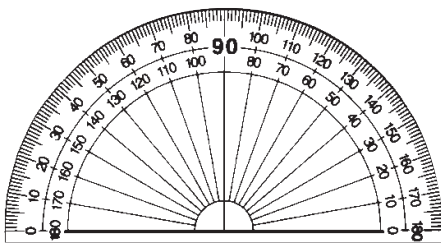

A protractor is used to measure an angle and also to draw an angle according to a given measure.

The picture opposite shows a protractor.

A protractor is semi-circular in shape.

The semi-circular edge of a protractor is divided into 180 equal parts. Each part is ‘one degree’. ‘One degree’ is written as ‘ 1° ’.

The divisions on a protractor, i.e., the degrees can be marked in two ways. The divisions 0, 10, 20,

30,...180 are marked anticlockwise or from right to left; the divisions 0, 10, 20, 30,...180 are also marked clockwise, or serially from left to right.

The centre of the circle of which the protractor is a half part, is called the centre of the protractor. A diameter of that circle is the baseline or line of reference of the protractor.

□ Measuring angles

Observe how to measure $\angle ABC$ given alongside, using a protractor.

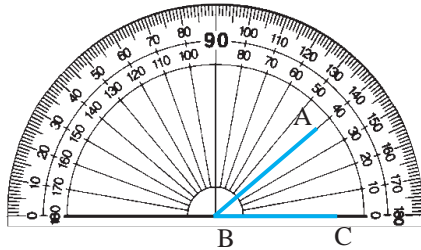
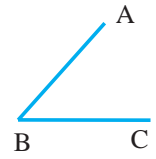

1. First, put the centre of the protractor on the vertex B of the angle. Place the baseline of the protractor exactly on arm BC. The arms of the angle do not reach the divisions on the protractor.

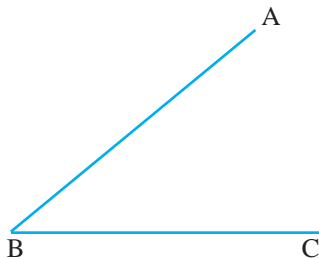

2. At such times, set the protractor aside and extend the arms of the angle.

Extending the arms of the angle does not change the measure of the angle.

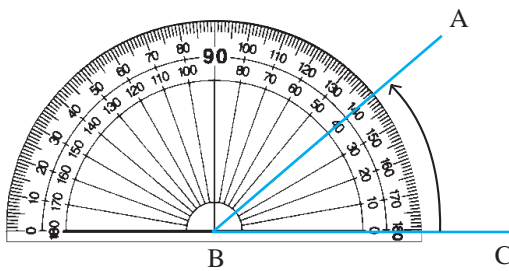

3. The angle is measured starting from the zero on that side of the vertex on which the arm of the angle lies. Here, the arm BC is on the right of the vertex B. Therefore, count the divisions starting from the 0 on the right. See which mark falls on arm BA. Read the number on that mark. This number is the measure of the angle.

The measure of $\angle ABC$ is 40° .

We can measure the same $\angle ABC$ by positioning the protractor differently.

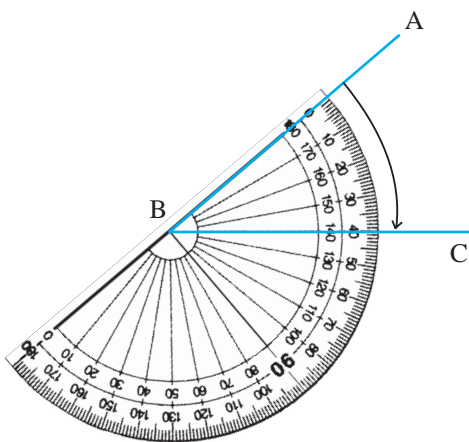

1. First put the centre point of the protractor on vertex B of the angle. Align the baseline of the protractor with arm BA.
2. Find the 0 mark on the side of BA. Count the marks starting from the 0 on the side of point A. See which mark falls on arm BC. Read the number at that point.

Observe that here, too, the measure of $\angle ABC$ is 40° .

❖ See how the angles given below have been measured with the help of a protractor.

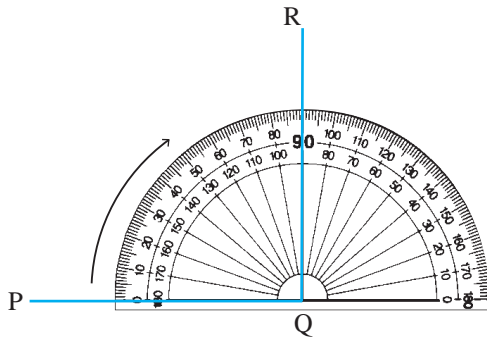

Measure of $\angle PQR$ is: 90°

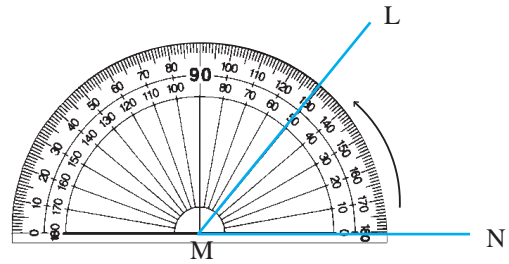

Measure of $\angle LMN$ is: 50°

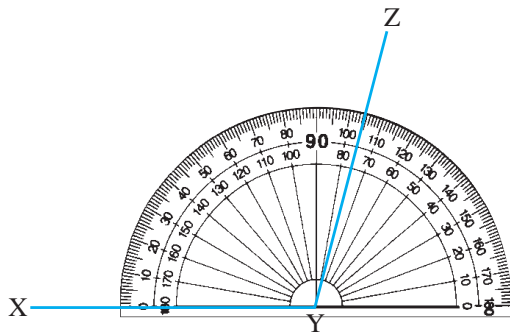

Measure of $\angle XYZ$ is: 105°

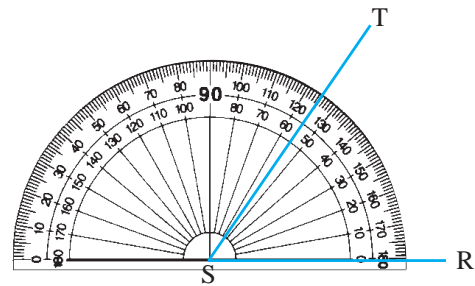

Measure of $\angle RST$ is: 55°

Problem Set 25

Measure the angles given below and write the measure in the given boxes.

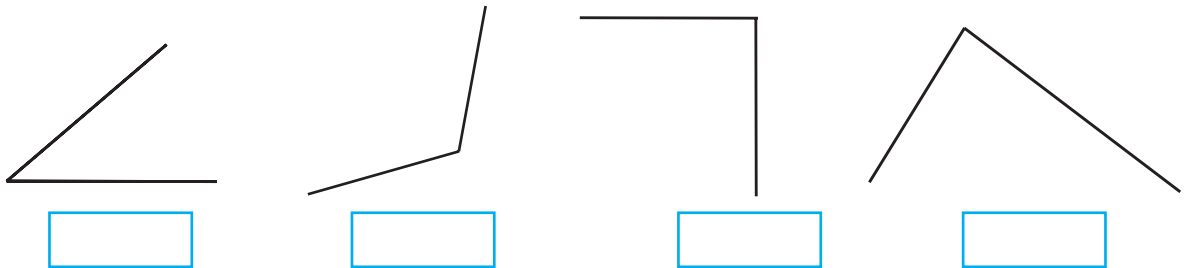

□ Drawing an angle of the given measure

Example Draw $\angle ABC$ of measure 70° .

B is the vertex of $\angle ABC$ and BA and BC are its arms.



1. First draw arm BC with a ruler.
2. Since B is the vertex, we must draw a 70° angle at that point.

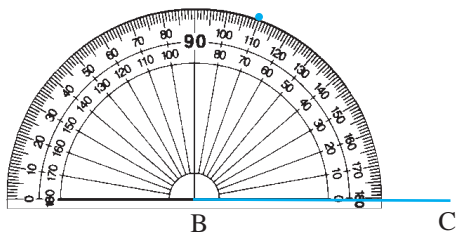

Put the centre of the protractor on B. Place the protractor so that the baseline lies on arm BC. Count the divisions starting from the 0 near point C. Mark a point with your pencil at the division that shows 70° . Lift the protractor.

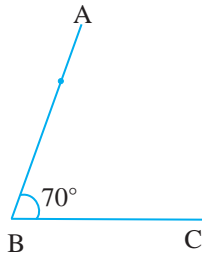

Draw a line from vertex B through the point marking the 70° angle. Name the other end of the line A.

$\angle ABC$ is an angle of measure 70° .

❖ Rahul and Sayali drew $\angle PQR$ of measure 80° as shown below.

Rahul's angle

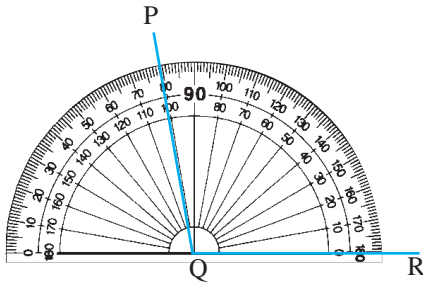

Sayali's angle

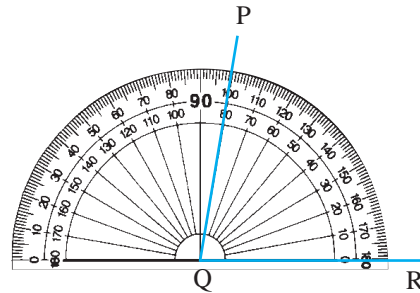

Teacher : Have Rahul and Sayali drawn the angles correctly ?

Shalaka : Sir, Rahul's angle is wrong. Sayali's angle is correct.

Teacher : Why is Rahul's angle wrong ?

Rahul : I counted 10, 20, 30...from the left and drew the angle at 80.

Teacher : Rahul measured the angle from the left. Under the baseline on the left of Q, there is nothing. The arm of the angle is on the right of Q. Therefore, the point should have been marked 80° counting from the right side, that is, on the side on which point R lies.

Problem Set 26

Draw and name the following angles with the help of a protractor.

- (1) 60° (2) 120° (3) 90° (4) 150° (5) 30° (6) 165° (7) 45°

Types of angles

Right angle

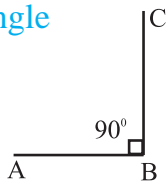

$\angle ABC$ is a right angle.

Angles of measure 90° are called right angles.

Acute angle

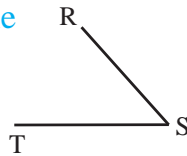

$\angle RST$ measures less than 90° , that is, less than a right angle.

An angle which measures less than a right angle is called an acute angle.

$\angle RST$ is an acute angle.

Obtuse angle

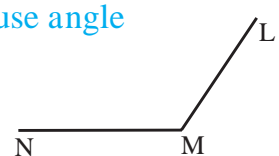

$\angle LMN$ measures more than 90° , that is, more than a right angle.

An angle which measures more than a right angle is called an obtuse angle.

$\angle LMN$ is an obtuse angle.

Activity : Making a right angle by folding

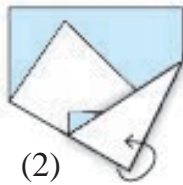
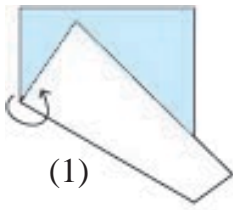

- (1) Fold a sheet of paper roughly in half.
- (2) Make another fold in the paper at any point on the first fold, as shown in the picture.
- (3) Now unfold the paper. You will find two lines. The angle between those two lines will be a right angle.

With the help of a protractor, verify that the measure of this angle is 90° .

Parallel and perpendicular lines

Parallel lines

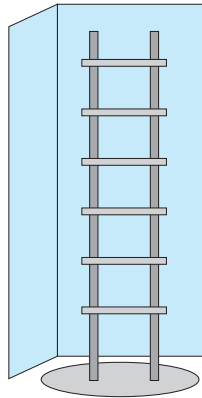
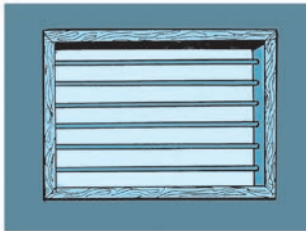

The **bars on the window** in the picture are parallel to each other.

The **steps on the ladder** in the picture are parallel to each other.

The **vertical legs of the ladder** are parallel to each other.

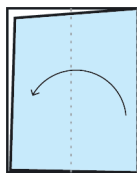
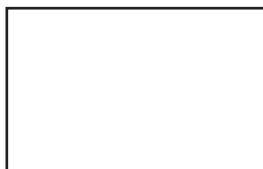

1. Take a rectangular piece of paper.
2. Fold it in such a way that one edge falls exactly on the opposite edge.
3. Make another fold in the same way.
4. Unfold the paper and trace the lines made by the folds, with a pencil.

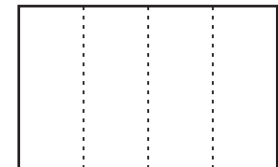
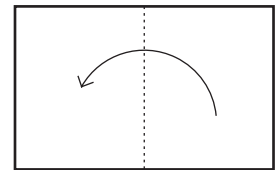

The lines traced with the pencil are parallel to each other.



The lines shown alongside are not of equal length, yet they are **parallel** to each other.

Parallel lines do not intersect, that is, they do not cut each other, no matter how far they are extended on either side.

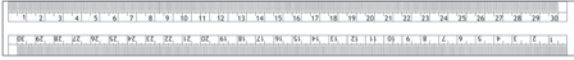

Take a ruler as shown in the picture.

Using a pencil, draw lines along both sides of the ruler. Put the ruler aside. The two lines are parallel to each other.

In this way, we can use several rectangular objects to draw parallel lines.

□ Perpendicular lines

We have seen many objects standing straight on the ground. These objects form a right angle with their shadows.

For example, the angle formed by a pole and its shadow on the ground is 90° or a right angle. Similarly, adjacent sides of wooden planks or books also form angles of 90° .

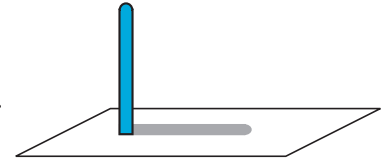

When two lines form an angle of 90° with each other, they are said to be **perpendicular** to each other. To show that two lines are perpendicular, a symbol as shown the figure is drawn between them.



Measure the angle between any two adjacent sides of your notebook.

Since it is a right angle, the two sides are perpendicular to each other.



Look at this picture of a page of a notebook.

The horizontal lines on the paper are parallel to each other. However, the vertical margin line on the side forms a right angle with the horizontal lines, therefore, it is perpendicular to the horizontal lines.

Problem Set 27

1. Give two examples of parallel lines you can see in your environment.
2. Give two examples of perpendicular lines you can see in your environment.
3. Look at the pictures given below. Decide whether the lines given in each picture are parallel or perpendicular to each other and write the answer in the box.

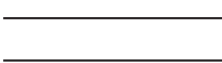

Parallel lines



Perpendicular lines





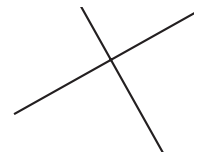

7. Circles



□ **Radius, chord and diameter**

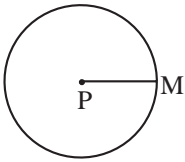

1. The line joining the centre of the circle to any point on the circle is called a **radius** of the circle.

In the diagram, P is the centre of the circle while M is a point on the circle. PM is a radius of the circle.

A circle has many radii. They are all of the same length.

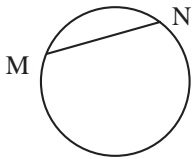

2. A line joining any two points on a circle is called a **chord**.

In the diagram, M and N are two points on the circle.

Line MN is a chord of the circle.

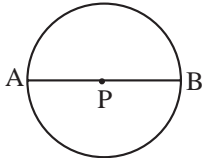

3. A chord passing through the centre of the circle is called a **diameter**.

In the diagram, chord AB passes through the centre P. Therefore, chord AB is also a diameter of the circle.

A circle has many chords and diameters.

- The centre of the circle below is O. There are other points and lines given in the diagram. Find the radii, chords and diameters in the diagram and write their names in the box provided.

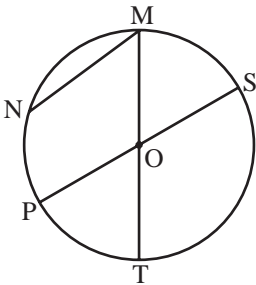

Radius	
Diameter	
Chord	

□ **Drawing a circle**

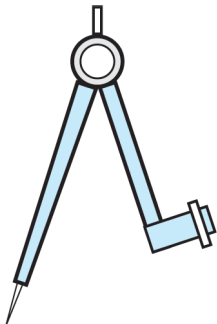

We use a compass to draw a circle. One arm of the compass has a metal point while the other arm has a place to fix a pencil. A pencil of a suitable length is fixed to the compass.

□ How to draw a circle using a compass

- First fix the pencil to the compass. Align the metal tip of the compass with the pencil point as shown in the picture on the right.

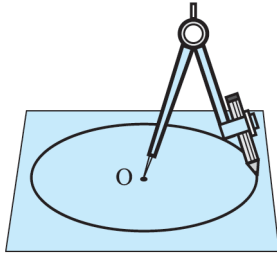

- Take a convenient distance between the pencil point and the metal tip.
- Take any point on a piece of paper.
- Hold the metal tip steady on the chosen point and turn the pencil point around it on the sheet of paper. The shape created by the pencil point will be a circle.

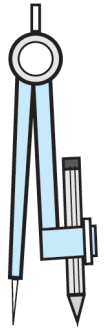

The point at which the metal tip of the compass is held is the **centre** of the circle. In this diagram, C is the centre of the circle.

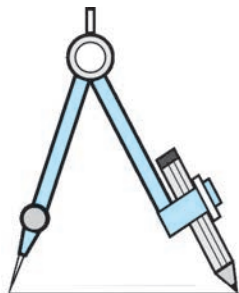
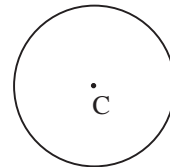

To draw a circle of a given radius, a distance equal to the radius is kept between the pencil point and the metal tip of the compass. In the accompanying diagram, this distance is 3 cm. Therefore, the radius of the circle drawn using this distance is 3 cm.



Problem Set 28

1. Draw circles with the radii given below.
 - (1) 2 cm
 - (2) 4 cm
 - (3) 3 cm
2. Draw a circle of any radius. Show one diameter, one radius and one chord on that circle.

□ Relationship between radius and diameter

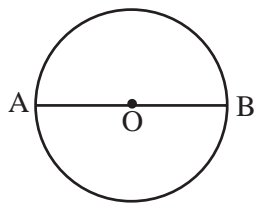

Study the circle given alongside. Think over the following questions.

- Which are the radii in the circle?
- How many radii make up diameter AB?
- If the length of one radius is 3 cm, what is the length of the diameter?
- How long is the diameter as compared to the radius?

The diameter of a circle is twice the length of its radius.

- If another diameter CD is drawn on the same circle, will its length be the same as that of AB?

All the diameters of a circle are of the same length.

Test 1 : Measure the diameters and radii of the circles given below with a ruler and verify the relationship between their lengths.

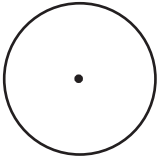
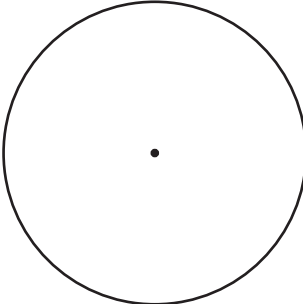
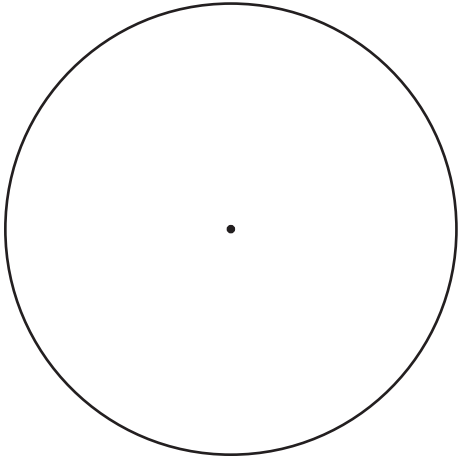
Diagram			
Radius	1 cm		
Diameter	2 cm		

Test 2 :

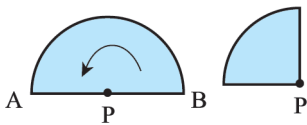
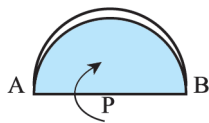
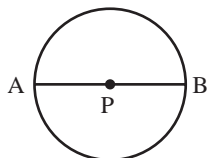

1. Draw a circle on a piece of paper and cut it out.
2. Name the centre of the circle P.
3. Draw the diameter of the circle and name it AB. Note that PA and PB are radii of the circle.
4. Fold the circular paper along AB as shown in the picture.

Fold the paper at P in such a way that point B will fall on point A. Radius PB falls exactly on radius PA. In other words, they coincide.

From this, we can see that every radius of a circle is half the length of its diameter.

Problem Set 29

1. If the radius of a circle is 5 cm, what will its diameter be?
2. If the diameter of a circle is 6 cm, what will its radius be?

3. Complete the following table by filling in the blanks.

Radius	4 cm		9 cm	
Diameter		16 cm		22 cm

The interior and the exterior of a circle

We play 'Land and Sea' inside a circle on the playground. In this game, the children inside the circle are in the 'sea', while the children outside the circle are on 'land'.

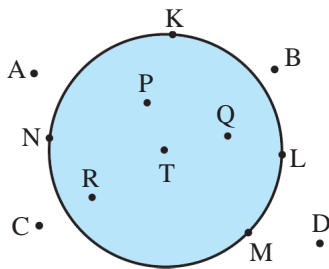

In the picture alongside, K, L, M and N are points on a circle with centre T.

The coloured area inside the circle in the picture is the interior of the circle. P, Q, R and T are points in the interior of the circle.

A, B, C and D are points in the exterior of the circle.

Problem Set 30

In the table below, write the names of the points in the interior and exterior of the circle and those on the circle.

Diagram	Points in the interior of the circle	Points in the exterior of the circle	Points on the circle

The circumference of a circle

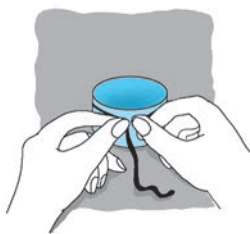

Take a bowl with a circular edge.

Wind a string once around the bowl and make a full circle around it.

Unwind this circle and straighten it out as shown.

Measure the straightened part with a ruler. The length of that part is the circumference of the circle or of the bowl.

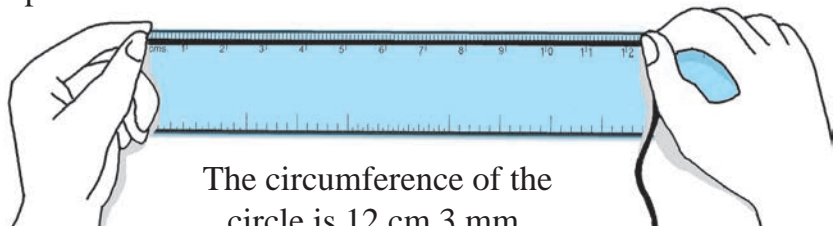

The circumference of the circle is 12 cm 3 mm.

□ An arc of a circle

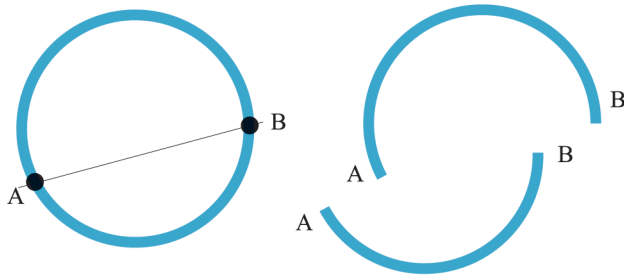

Shown alongside is a plastic bangle. If the bangle breaks at points A and B, it will split into two parts as shown in the picture.

Each of these parts is an **arc of a circle**.

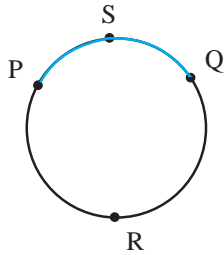

On the given circle, there are two points P and Q. These two points have divided the circle into two parts. Each of these parts is an **arc of the circle**.

This means that P and Q have created two arcs. P and Q are the end points of both arcs.

From the name 'arc PQ', we cannot say which of the two arcs we are speaking of. So, an additional point is taken on each arc. This point is used to give each arc a three-letter name. In the figure, there are two arcs, arc PSQ and arc PRQ.

Problem Set 31

1. In the figure given alongside, points S, L, M and N are on the circle. Answer the questions with the help of the diagram.

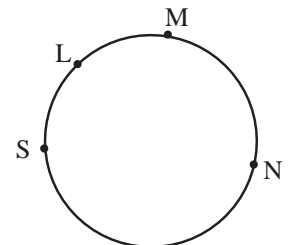

- (1) Write the names of the arcs with end-points S and M.
- (2) Write the names of the arcs with the end-points L and N.

2. Write the names of arcs that points A, B, C and D in the given circle give rise to.

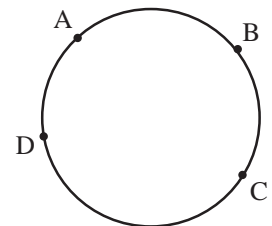

3. Give the names of the arcs that are made by points P, Q, R, S and T in the figure.

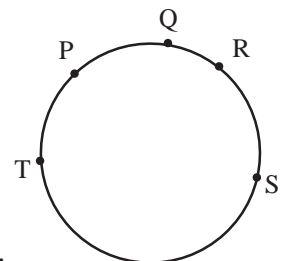

4. Measure and note down the circumference of different circular objects. (It is convenient to use a measuring tape for this purpose.)





8. Multiples and Factors

Dada : I have 12 pedhas. I have to put them in equal groups so that no pedha is left over. How many pedhas must I put in each group ?

Sanju : Putting into groups means dividing. None left over means that the remainder will be 0.

Anju : 12 is divisible by 2, so we can make groups of two.

Manju : 12 is divisible by 3, so we can make groups of 3.

Sagar : We can also make groups of four.

Anita : Can we make groups of five?

Manju : No, because 12 is not divisible by 5.

Anju : We can divide 12 by six, so groups of six can be made.

Manju : We cannot make groups of 7, 8, 9, 10 or 11 because we cannot divide 12 by any of these numbers.

Sanju : We could make one group of twelve and give it to one person. Or, we could give 12 people 1 pedha each.

Dada : Very good. 12 is exactly divisible by 1, 2, 3, 4, 6 and 12, which means the remainder is 0. These numbers are called divisors or factors of 12. Similarly, 1, 2, 4, 8 and 16 are factors of 16.

Problem Set 32

Write the factors of the following numbers.

- (1) 8 (2) 5 (3) 14 (4) 10 (5) 7 (6) 22 (7) 25 (8) 32 (9) 33

Multiples

Dada : You know what a divisor and a dividend is. Do you know what a multiple is ?

Anju : I don't know what a multiple is, but I think it must be related to multiplication.

Dada : Right ! Let me give you an example. You can solve 20 ÷ 5, can't you ?

Anju : Yes. When we divide the dividend 20 by the divisor 5, the quotient is 4 and the remainder is 0.

Dada : When the division of a dividend leaves no remainder, the dividend is said to be a multiple of the divisor. In such a case, the dividend is the product of the divisor and the quotient. Here, 20 is a multiple of 5, but 21 is not.

Now tell me, can we divide 84 chalksticks into groups of six ?

Suraj : Let me divide by 6. 84 can be divided exactly by 6 and the quotient is 14. Thus, we can make 14 groups of 6. So, 84 is the multiple of 6 and 6 is a factor of 84.

Dada : If the number of chalksticks is 6, 12, 18, 36 or 84, then we can make exact groups of 6 with none left over. It means that 6, 12, 18, 36 and 84 are multiples of 6, or that they are exactly divisible by 6. To see whether the number of chalksticks is a multiple of 6, divide that number by 6. If the remainder is 0, the number is a multiple of 6.

Each number in the 3 times table is exactly divisible by 3 or is a multiple of 3. Similarly, the numbers in the 7 times table are multiples of 7. Numbers in the 9 times table are multiples of 9.

We use this idea all the time. Let me ask you a few questions so as to make it clear. I have a 200 *ml* measure. Will I be able to measure out 1 litre of milk with it?

Suraj : 1 litre is 1000 *ml*. $1000 = 200 \times 5$, which means that 1000 is a multiple of 200. So we can measure out 1 litre of milk with the 200 millilitre measure. 5 measures of 200 *ml* make 1 litre.

Dada : Can we measure out one and a half litres of milk with the 200 *ml* measure?

Anju : One and a half litres is 1500 *ml*. 1500 is not divisible by 200. So, it is not a multiple of 200. So the 200 *ml* measure cannot be used to measure out one and a half litres of milk.

Dada : I have 400 grams of *chana*. I have to make pouches of 60 grams each. Is that possible, if I don't want any left overs?

Anju : No. 400 is not a multiple of 60.

Dada : How much more *chana* will I need to make those pouches of 60 grams each?

Anju : We will have to find the multiple of 60 that comes directly after 400.

$60 \times 6 = 360$, $60 \times 7 = 420$. So, we need 20 grams more of *chana*.

□ Tests for divisibility

Study the 2 times table and see which numbers appear in the units place. Similarly, divide 52, 74, 80, 96 and 98 by 2 to see if they are exactly divisible by 2. What rule do we get for determining whether a number is a multiple of 2?

Now study the 5 and 10 times tables.

See what rules you get for finding multiples of 5 and 10, that is, numbers divisible by 5 and 10.

Test for divisibility by 2 : If there is 0, 2, 4, 6 or 8 in the units place, the number is a multiple of 2, or is exactly divisible by 2.

Test for divisibility by 5 : Any number with 5 or 0 in the units place is a multiple of 5 or, is divisible by 5.

Test for divisibility by 10 : Any number that has 0 in the units place is a multiple of 10.

Problem Set 33

1. (1) Write five three-digit numbers that are multiples of 2.
 (2) Write five three-digit numbers that are multiples of 5.
 (3) Write five three-digit numbers that are multiples of 10.
2. Write 5 numbers that are multiples of 2 as well as of 3.
3. A ribbon is 3 metres long. Can we cut it into 50 cm pieces and have nothing left over? Write the reason why or why not.
4. A ribbon is 3 metres long. I need 8 pieces of ribbon each 40 cm long. How many centimetres shorter is the ribbon than the length I need?
5. If the number given in the table is divisible by the given divisor, put ✓ in the box. If it is not divisible by the divisor, put × in the box.

Divisor \ Number	2	5	10
15	×	✓	×
30			
34			
46			

Divisor \ Number	2	5	10
55			
63			
70			
84			

□ Prime and composite numbers

Some numbers are given in the tables below. Write all of their factors.

Numbers	Factors
2	1, 2
3	1, 3
4	1, 2, 4
5	
6	

Numbers	Factors
11	
12	
16	
19	
25	

Dada : What do you notice on studying the table?

Ajay : The number 1 is a factor of every number. Some numbers have only 1 and the number itself as factors. For example, the only factors of 3 are 1 and 3. Similarly, the factors of 2 are only 1 and 2 and the factors of 19 are only 1 and 19. Some numbers have more than two factors.

Dada : Numbers like 2, 3, 19 which have only two factors are called prime numbers.

A number which has only two factors, 1 and the number itself, is called a prime number.

Ajay : What do we call numbers like 4, 6 and 16 which have more than two factors?

Dada : Numbers like 4, 6 and 16 are called composite numbers.

A number which has more than two factors is called a composite number.

Dada : Think carefully and tell me whether 1 is a prime or composite number.

Ajay : The number 1 has only one factor, 1 itself, so I can't answer your question.

Dada : You're right. 1 is considered neither a prime number nor a composite number.

1 is a number which is neither prime nor composite.

Problem Set 34

1. Write all the prime numbers between 1 and 20.
2. Write all the composite numbers between 21 and 50.
3. Circle the prime numbers in the list given below.
22, 37, 43, 48, 53, 60, 91, 57, 59, 77, 79, 97, 100
4. Which of the prime numbers are even numbers?

□ Co-prime numbers

Dada : Tell me all the factors of 12 and 18.

Anju : I'll tell the factors of 12: 1, 2, 3, 4, 6, 12.

Manju : I'll give the factors of 18: 1, 2, 3, 6, 9, 18.

Dada : Now find the common factors of 12 and 18.

Anju : Common factors?

Dada : 1, 2, 3 and 6 are in both groups, which means that they are common factors. Now tell me the factors of 10 and 21.

Sanju : Factors of 10 : 1, 2, 5, 10.

Manju : Factors of 21: 1, 3, 7, 21.

Dada : Which of the factors in these two groups are common?

Sanju : 1 is the only common factor.

Dada : Numbers which have only 1 as a common factor are called **co-prime numbers**, so 10 and 21 are co-prime numbers. The common factors of 12 and 18 are 1, 2, 3 and 6; which means that the common factors are more than one. Therefore, 12 and 18 are not co-prime numbers. Now tell me whether 8 and 10 are co-prime numbers.

Manju : The factors of 8 are 1, 2, 4 and 8 and the factors of 10 are 1, 2, 5 and 10. These numbers have two factors, 1 and 2, in common, so 8 and 10 are not co-prime numbers.

Problem Set 35

Determine whether the pairs of numbers given below are co-prime numbers.

- | | | | |
|------------|------------|------------|------------|
| (1) 22, 24 | (2) 14, 21 | (3) 10, 33 | (4) 11, 30 |
| (5) 5, 7 | (6) 15, 16 | (7) 50, 52 | (8) 17, 18 |

- Activity 1 :**
- Write numbers from 1 to 60.
 - Draw a blue circle around multiples of 2.
 - Draw a red circle around multiples of 4.
 - Do all numbers with a blue circle also have a red circle around them?
 - Do all the numbers with a red circle have a blue circle around them?
 - Are all multiples of 2 also multiples of 4?
 - Are all multiples of 4 also multiples of 2?.

- Activity 2 :**
- Write numbers from 1 to 60.
 - Draw a triangle around multiples of 2.
 - Draw a circle around multiples of 3.
 - Now find numbers divisible by 6. Can you find a property that they share?

□ Eratosthenes' method of finding prime numbers

Eratosthenes was a mathematician who lived in Greece about 250 BC. He discovered a method to find prime numbers. It is called Eratosthenes' Sieve. Let us see how to find prime numbers between 1 and 100 with this method.

1	11	21	31	41	51	61	71	81	91
2	12	22	32	42	52	62	72	82	92
3	13	23	33	43	53	63	73	83	93
4	14	24	34	44	54	64	74	84	94
5	15	25	35	45	55	65	75	85	95
6	16	26	36	46	56	66	76	86	96
7	17	27	37	47	57	67	77	87	97
8	18	28	38	48	58	68	78	88	98
9	19	29	39	49	59	69	79	89	99
10	20	30	40	50	60	70	80	90	100

- 1 is neither a prime nor a composite number. Put a square □ around it
- 2 is a prime number, so put a circle around it.
- Next, strike out all the multiples of 2. This tells us that of these 100 numbers more than half numbers are not prime numbers.

- The first number after 2 not yet struck off is 3. So, 3 is a prime number.
- Draw a circle around 3. Strike out all the multiples of 3.
- The next number after 3 not struck off yet is 5. So, 5 is a prime number.
- Draw a circle around 5. Put a line through all the multiples of 5.
- The next number after 5 without a line through it is 7. So, 7 is a prime number.
- Draw a circle around 7. Put a line through all the multiples of 7.

In this way, every number between 1 and 100 will have either a circle or a line through it. The circled numbers are prime numbers. The numbers with a line through them are composite numbers.

□ One more method to find prime numbers

1	2	3	4	5	6
7	8	9	10	11	12
13	14	15	16	17	18
19	20	21	22	23	24
25	26	27	28	29	30
31	32	33	34	35	36
–	–	–	–	–	–
–	–	–	–	–	–

- See how numbers from 1 to 36 have been arranged in six columns in the table alongside.

Continue in the same way and write numbers up to 102 in these six columns.

- You will see that, in the columns for 2, 3, 4, and 6, all the numbers are composite numbers except for the prime numbers 2 and 3. This means that all the remaining prime numbers will be in the columns for 1 and 5. Now isn't it easier to find them? So, go ahead, find the prime numbers !

Something more

- Prime numbers with a difference of two are called twin prime numbers. Some twin prime number pairs are 3 and 5, 5 and 7, 29 and 31 and 71 and 73. 5347421 and 5347423 are also a pair of twin prime numbers.
- There are eight pairs of twin prime numbers between 1 and 100. Find them.
- Euclid the mathematician lived in Greece about 300 BC. He proved that if prime numbers, 2, 3, 5, 7,, are written in serial order, the list will never end, meaning that the number of prime numbers is infinite.





9. Decimal Fractions

Soumitra : Sir, today I saw MRP ₹ 24.50 printed on a box of medicine. What does it mean?

Teacher : MRP means maximum retail price – the seller can sell that medicine for a maximum of 24 rupees and 50 paise.

Rekha : But how does ‘₹ 24.50’ mean ‘twenty-four rupees fifty paise’?

Teacher : ‘24.50’ has been written in decimal form. To understand the answer to your question, you will first have to learn about decimal fractions and the way they are written.



□ Decimal fractions

A fraction whose denominator is 10, 100 or 1000 or any other ten times multiple of 10 is called a decimal fraction. For example, $\frac{5}{10}$, $\frac{68}{100}$, $\frac{285}{100}$. These fractions are written in the numerator and denominator form.

It is convenient to write these fractions in another way. To use this new method, let us look at our usual method of writing numbers. In this method, we make new places for tens, hundreds, thousands and so on. The place value of each of these is 10 times that of the previous place. For example, one ten equals 10 units, one hundred equals 10 tens and so on.

Now let us think in the opposite direction. If we divide one hundred into 10 equal parts, each part is one ten. The tens place is to the right of the hundred. One ten is divided into ten parts. Each part is one unit. The units place is to the right of the tens place.

Similarly, if one unit is divided into ten equal parts, each part becomes $\frac{1}{10}$. For this, a place is made to the right of the units place. $\frac{1}{10}$ means ‘one-tenth’. This place is called the tenths place or the first decimal place.

□ The decimal point

The decimal place is created for writing a fraction. When writing numbers, a dot (.) is written after the last digit of the whole part of a number to indicate the end of that part.

This symbol is called a **decimal point**. The decimal point is used to write $8\frac{5}{10}$ as 8.5. This is read as ‘eight point five’.

‘ $20\frac{3}{10}$ ’ is written as ‘20.3’.

‘Seven tenths’ can be written as ‘ $\frac{7}{10}$ ’ or ‘0.7’.

‘ $\frac{7}{10}$ ’ is the usual way of writing the number and ‘0.7’ is the decimal way.

Problem Set 36

Write the following mixed fractions in decimal form and read them aloud.

- (1) $3 \frac{9}{10}$ (2) $1 \frac{4}{10}$ (3) $5 \frac{3}{10}$ (4) $\frac{8}{10}$ (5) $\frac{7}{10}$

□ Hundredths

If $\frac{1}{10}$ is divided into 10 equal parts, each part becomes $\frac{1}{100}$ or one hundredth. Therefore, note that 1 tenth = 10 hundredths, or $0.1 = 0.10$. By multiplying $\frac{1}{100}$ by 10 we get $\frac{10}{100} = \frac{1}{10}$. Therefore, it is possible to create a hundredths place next to the tenths place. After creating a hundredths place we can write $\frac{14}{100}$ as 0.14.

$\frac{14}{100} = \frac{10+4}{100} = \frac{10}{100} + \frac{4}{100} = \frac{1}{10} + \frac{4}{100}$ meaning that when writing $\frac{14}{100}$ in decimal form, 1 is written in the tenths place and 4 is written in the hundredths place. This fraction is written as 0.14 and is read as 'zero point one four'. Similarly, $6 \frac{57}{100}$ is written as 6.57 and $50 \frac{71}{100}$ is written as 50.71.

While writing $\frac{3}{100}$ in decimal form, we must remember that there is **no number in the tenths place** and so, we put 0 in that place, which means that $\frac{3}{100}$ is written as 0.03.

Study how the decimal fractions in the table below are written and read.

Fractions	Tens	Units	Tenths	Hundredths	Decimal fractions in figures	Decimal fractions in words
$7 \frac{5}{10}$		7	5		7.5	Seven point five
$7 \frac{5}{100}$		7	0	5	7.05	Seven point zero five
$\frac{82}{100}$		0	8	2	0.82	Zero point eight two
$25 \frac{6}{100}$	2	5	0	6	25.06	Twenty-five point zero six

Problem Set 37

Write the following mixed fractions in decimal form and read them aloud.

- (1) $9 \frac{1}{10}$ (2) $9 \frac{1}{100}$ (3) $4 \frac{53}{100}$ (4) $\frac{78}{100}$ (5) $\frac{5}{100}$ (6) $\frac{5}{10}$ (7) $\frac{2}{10}$ (8) $\frac{20}{100}$

□ Place value of the digits in decimal fractions

We can determine the place value of the digits in decimal fractions in the same way that we determine the place values of digits in whole numbers.

Example (1) In 73.82, the place value of 7 is $7 \times 10 = 70$, and of 3, it is $3 \times 1 = 3$.

Similarly, the place value of 8 is $8 \times \frac{1}{10} = \frac{8}{10} = 0.8$ and

the place value of 2 is $2 \times \frac{1}{100} = \frac{2}{100} = 0.02$

Example (2) Place values of the digits in 210.86.

Digits	2	1	0	8	6
Place	Hundreds	Tens	Units	Tenths	Hundredths
Place value	$2 \times 100 = 200$	$1 \times 10 = 10$	0	$8 \times \frac{1}{10} = 0.8$	$6 \times \frac{1}{100} = 0.06$

○ Problem Set 38 ○

Read the decimal fraction and write down the place value of each digit.

(1) 6.13

(2) 48.84

(3) 72.05

(4) 3.4

(5) 0.59

□ Use of decimal fractions

Sir : Now we will see how 24.50 equals 24 rupees and 50 paise. How many rupees is one paise ?

Sumit : 100 paise make one rupee, therefore, 1 paise is one hundredth of a rupee or 0.01 rupee.

Sir : And 50 paise are ?

Sumit : 50 hundredths of a rupee, or 0.50 rupees, so 24.50 rupees is 24 rupees and 50 paise.

Sir : When a large unit of a certain quantity is divided into 10 or 100 parts to make smaller units, it is more convenient to write them in decimal form. As we just saw, 100 paise = 1 rupee. Similarly, 100 cm = 1 metre, so 75 cm = 0.75 m. 10 mm = 1 cm, so 1 mm = 0.1cm. 3 mm are 0.3 cm. 6.3 cm are 6 cm and 3 mm.

Now study the following table.

100 paise = 1 rupee	100 cm = 1 m
1 paise = $\frac{1}{100}$ rupee = 0.01 rupee	1 cm = $\frac{1}{100}$ m = 0.01 m
50 paise = $\frac{50}{100}$ rupee = 0.50 rupee	25 cm = $\frac{25}{100}$ m = 0.25 m
75 paise = $\frac{75}{100}$ rupee = 0.75 rupee	60 cm = $\frac{60}{100}$ m = 0.60 m = 0.6 m

1 rupee = 100 paise	1 m = 100 cm
5 rupees = 500 paise	8 m = 800 cm
0.50 rupee = 0.5 rupee = 50 paise	0.3 m = 30 cm
0.07 rupee = 7 paise	0.40 m = 40 cm
4.5 rupees = 4 rupees 50 paise	2.65 m = 2 m 65 cm
17.65 rupees = 17 rupees 65 paise	14.9 m = 14 m 90 cm

Problem Set 39

1. Write how many rupees and how many paise.

- (1) ₹ 58.43 (2) ₹ 9.30 (3) ₹ 2.30 (4) ₹ 2.3

2. Write how many rupees in decimal form.

- (1) 6 rupees 25 paise (2) 15 rupees 70 paise (3) 8 rupees 5 paise
(4) 22 rupees 4 paise (5) 720 paise

3. Write how many metres and how many centimetres.

- (1) 58.75 m (2) 9.30 m (3) 0.30 m (4) 0.3 m
(5) 1.62 m (6) 91.4 m (7) 7.02 m (8) 0.09 m

4. Write how many metres in decimal form.

- (1) 1 m 50 cm (2) 50 m 40 cm (3) 50 m 4 cm (4) 734 cm
(5) 10 cm (6) 2 cm

5. Write how many centimetres and how many millimetres.

- (1) 6.9 cm (2) 20.4 cm (3) 0.8 cm (4) 0.5 cm

6. Write how many centimetres in decimal form.

- (1) 7 cm 1 mm (2) 16 mm (3) 144 mm (4) 8 mm

□ Writing half, quarter, three-quarters and one and a quarter in decimal form

‘Half’ is usually written as $\frac{1}{2}$. To convert this fraction into decimal form, the denominator of $\frac{1}{2}$ must be converted into an equivalent fraction with denominator 10.

$$\frac{1}{2} = \frac{1 \times 5}{2 \times 5} = \frac{5}{10} \text{ so the decimal form of } \frac{1}{2} \text{ will be } \frac{5}{10} \text{ or } 0.5$$

$$\text{Just as } \frac{1}{2} = \frac{1 \times 5}{2 \times 5} = \frac{5}{10} = 0.5, \text{ note that } \frac{1}{2} = \frac{1 \times 50}{2 \times 50} = \frac{50}{100} = 0.50$$

Therefore, ‘half’ is written as ‘0.5’ or 0.50’. ‘Quarter’ and ‘three quarters’ are written in fractions as $\frac{1}{4}$ and $\frac{3}{4}$ respectively. Let us convert them into decimal fractions. 10 is not divisible by 4. Therefore, the denominators of $\frac{1}{4}$ and $\frac{3}{4}$ cannot be made into fractions with multiples of 10. However, $4 \times 25 = 100$, so the denominator can be 100.

$$\text{A quarter} = \frac{1}{4} = \frac{1 \times 25}{4 \times 25} = \frac{25}{100} = 0.25$$

and

$$\text{Three quarters} = \frac{3}{4} = \frac{3 \times 25}{4 \times 25} = \frac{75}{100} = 0.75$$

$$\text{One and a quarter} = 1 \frac{1}{4} = 1.25$$

$$\text{One and a half} = 1 \frac{1}{2} = 1.50 = 1.5$$

$$\text{One and three quarters} = 1 \frac{3}{4} = 1.75$$

$$\text{Seventeen and a half} = 17 \frac{1}{2} = 17.50 = 17.5$$

Problem Set 40

Write the following fractions as decimal fractions.

- (1) Two and a half (2) Two and a quarter (3) Two and three quarters
 (4) Ten and a half (5) Fourteen and three quarters (6) Sixteen and a quarter
 (7) Twenty-eight and a half

□ Adding decimal fractions

Sir : If the cost of one pencil is two and a half rupees and the cost of a pen is four and half rupees, what is the total cost?

Sumit : Two and a half rupees means two rupees and one half rupee. Similarly, four and a half rupees means four rupees and one half rupee. 4 rupees and 2 rupees make 6 rupees and two half rupees make one rupee, so both objects together cost 6+1=7 rupees.

Sir : Correct! Now, see how this is done using decimals.

The sum of the 0's in the hundredths place is 0.

$$0.5 + 0.5 \text{ is the same as } \frac{5}{10} + \frac{5}{10} = \frac{5+5}{10} = \frac{10}{10} = \frac{1}{1} = 1$$

$$\begin{array}{r} 1 \\ 2.50 \\ + \\ 4.50 \\ \hline 7.00 \end{array}$$

This 1 is carried over to the units place. There is nothing in the tenths place, so we put a zero there. In the units place, 2 + 4 = 6 plus the carried over 1 makes 7.

So 2.50 rupees and 4.50 rupees add up to 7 rupees.

We use the decimal system to write whole numbers. We extend the same method to write fractions; therefore, we can add in the same way as we add whole numbers.

I will now show some more additions. Watch carefully.

$$(1) \begin{array}{r} + 3.7 \\ 12.2 \\ \hline 15.9 \end{array}$$

$$(2) \begin{array}{r} + 6.8 \\ 5.5 \\ \hline 12.3 \end{array}$$

$$(3) \begin{array}{r} + 16.9 \\ 7.5 \\ \hline 24.4 \end{array}$$

Sumit : There is no carried over number in the first sum, but there are carried over numbers in the second and third sums.

Rekha : While adding whole numbers, we add units first. Similarly, here, tenths are added first. In the second example, the sum of the tenths place is 13. 13 tenths are 10 tenths + 3 tenths = 1 unit + 3 tenths.

Sumit : That is why, in the sum, 3 stayed in the tenths place and 1 was carried over to the units place. $6 + 5$ plus 1 carried over makes 12.

Sir : Your observations are absolutely correct. We write digits one below the other according to their place values while adding whole numbers. We do the same thing here. Remember that while writing down an addition problem and the total, the decimal points should always be written one below the other.

Study the following additions. (Note that: 10 tenths = 1 unit. 10 hundredths = 1 tenth)

Example (1) Add : $7.09 + 54.93$

First, add the digits in the 100ths place. $9 + 3 = 12$.

	1	1	1	
+	7	. 0	9	
	5	4	. 9	3
	6	2	. 0	2

The 1 from the sum 12 in the hundredths place is carried over to the tenths place and 2 is written in the hundredths place. Adding $1 + 9$ gives 10 tenths or 1 unit. This 1 is carried over to the units place. 0 is left in the tenths place. Then, the addition is completed in the usual way.

Example (2) Add : $45.83 + 167.4$

$$\begin{array}{r} 45.83 \\ + 167.4 \\ \hline \end{array}$$

We arrange the numbers so that the places and decimal points come one below the other.

	1	1	1	
+	4	5	. 8	3
	1	6	7	. 4
	2	1	3	. 2

$\frac{4}{10} = \frac{4 \times 10}{10 \times 10} = \frac{40}{100}$ Therefore, to make the denominators of the fractions equal, 167.4 is written as 167.40 and then the fractions are added.

As usual, the digits with the smallest place values are added first and then those with bigger place values are added serially.

Example (3) 10.46 Rupees

$$\begin{array}{r} 10.46 \text{ Rupees} \\ + 35.92 \text{ Rupees} \\ \hline 46.38 \text{ Rupees} \end{array}$$

Example (4) 48.80 m

$$\begin{array}{r} 48.80 \text{ m} \\ + 2.57 \text{ m} \\ \hline 51.37 \text{ m} \end{array}$$

Example (5) 7.5 cm

$$\begin{array}{r} 7.5 \text{ cm} \\ + 14.2 \text{ cm} \\ + 9.6 \text{ cm} \\ \hline 31.3 \text{ cm} \end{array}$$

Problem Set 41

1. Convert the following into decimal fractions and add them.
 - (1) 'One and a half metre' and 'two and a half metres'
 - (2) 'Four and three quarter rupees' and 'seven and a quarter rupees'
 - (3) 'Six and a half metres' and 'three and three quarter metres'.
2. (1) $23.4 + 87.9$ (2) $35.74 + 816.6$ (3) $6.95 + 74.88$ (4) $41.03 + 9.98$
3. (1) $51.4 \text{ cm} + 68.5 \text{ cm}$ (2) $94.7 \text{ m} + 1738.45 \text{ m}$ (3) $\text{₹ } 5158.75 + \text{₹ } 841.25$

□ Subtraction of decimal fractions

Study the subtraction of decimal fractions given below.

$$\begin{array}{r} 15.41 \\ - 8.58 \\ \hline 6.83 \end{array}$$

T	U	Tenths	Hun-dredths
	14	13	
0	4	3	11
1	4	3	1
-	8	5	8
0	6	8	3

8 hundredths cannot be subtracted from 1 hundredth, so 1 tenth (or 10 hundredths) from 4 tenths are borrowed. The borrowed 10 hundredths and the original one hundredth make 11 hundredths. 11 hundredths minus 8 hundredths are 3 hundredths. They are written in the hundredths place under the line. The rest of the subtraction is carried out using the same method.

Problem Set 42

1. Subtract the following :

(1) $25.74 - 13.42$

(2) $206.35 - 168.22$

(3) $63.4 - 31.8$

(4) $63.43 - 31.8$

(5) $63.4 - 31.83$

(6) $8.23 - 5.45$

(7) $18.23 - 9.45$

(8) $78.03 - 41.65$

2. Vrinda was 1.48 m tall. After a year, her height became 1.53 m. How many centimetres did her height increase in a year?

Something more

□ Decimals used for measurement

We need to measure distance, mass (weight) and volume every day. We use suitable units for these measurements. Kilometre, metre and centimetre for distance; litre, millilitre for volume and kilogram and gram for mass are the units that are used most of the time.

All these units are decimal units. In this method, gram, metre and litre are taken as the basic units for mass, distance and volume respectively. Units larger than these increase 10 times at every step and smaller units become $\frac{1}{10}$ of the previous unit at each step.

Look at the table of these units given below.

Quantity	Kilo (Th) (Thousand)	Hecto (H) (Hundred)	Deca (Ten)	The basic unit of measurement	Deci (Tenth)	Centi (Hundredth)	Milli (Thousandth)
Distance	1 kilometre = 1000 m	1 hectometre = 100 m	1 decametre = 10 m	metre	1 decimetre = $\frac{1}{10}$ m	1 centimetre = $\frac{1}{100}$ m	1 millimetre = $\frac{1}{1000}$ m
Mass				gram			
Volume				litre			

The origin of the terms kilo, hecto... milli is in the Greek or Latin language. Their English equivalents are given in brackets along with the terms.



10. Measuring Time



Revision

Problem Set 43

1. Write the time shown in each clock in the box given below it.









2. Draw the hands of the clock to show the time given in the box.



Four thirty



Quarter past nine



Quarter to five



20 minutes past 11

- If a bus that leaves Nashik at 5 o'clock in the morning reaches Pune that same day at ten thirty in the morning, how long does the journey take ?
- A play that was to start at nine fifteen at night was delayed by half an hour because of a power outage. What time did the play start ?
- If a train leaves Mumbai at ten fifteen at night and reaches Nagpur at one forty the next afternoon, how long does the journey take ?

Learning about seconds



This clock is showing 5 minutes past 3. We know this because of the position of the hour and minute hands. There is another hand in the picture called the second hand. This hand moves swiftly. The second is a very small unit used to measure time less than a minute.

The face of a clock is a circle divided into 60 equal parts. When the second hand moves one part, it takes one second. When it completes one round of the clock face, it moves across all 60 parts. This takes 60 seconds. In the same time, the minute hand moves one place, which means that one minute is over.

It means that, 1 minute is equal to 60 seconds.

$$1 \text{ minute} = 60 \text{ seconds}$$

The clock in the picture above shows 5 minutes and 50 seconds past 3.



20 minutes and
10 seconds past 7



15 minutes and
40 seconds past 10

Seconds are used on various occasions such as measuring temperature with a thermometer, measuring heartbeats or timing a race.

☐ Ante meridiem and post meridiem

Shripati was sitting at home at night, tired. There were guests at home. They asked, “You must have worked very hard in the fields today. How long were you working ?”

Shripati said, “I was in the field from six o’clock to eight o’clock.”

Someone asked, “You’re this tired even though you were in the field for only two hours ?”

Shripati said, “No, no, I was in the field from 6 in the morning till 8 at night! Now tell me how many hours I spent in the field.”

The guests had not understood what Shripati said at first. To avoid such mistakes, it has been internationally agreed that as the clock strikes 12 midnight, one day ends and the next day begins. From that moment on, the clock shows the time for the next day. When one hour passes after 12 midnight, it is 1 o’clock. After that, it is 2, 3, 4, ..., 12 o’clock in serial order. After 12 noon, again it is 1, 2, 3, ..., 12 o’clock in serial order. The time before 12 noon is stated as ante meridiem or am. The time after 12 noon is stated as post meridiem or pm.

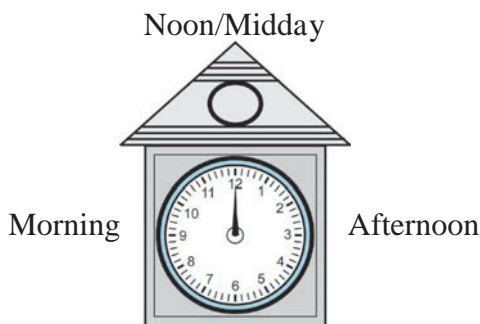

This method of measuring time is called the 12 hour clock.











Shripati was in the field from 6 am to 8 pm or for 14 hours.

☐ The 24 hour clock

The 24 hour clock is used to avoid this division of the day into ante meridiem and post meridiem. This method is used in timetables for trains, planes, buses and long distance boat journeys. In this method, instead of starting again from 1, 2, 3 after 12 noon, we continue with 13, 14, 15, ..., 24. In a 24 hour digital watch, time is shown only in the form of numbers. It does not have hands. In such a clock, 20 minutes past 6 in the morning is shown as ‘6:20’ and 20 minutes past 6 in the evening is shown as ‘18:20’.

23:59 means 59 minutes after 23 and one minute later, 24 hours will be complete. The digital clock will show this time as 00:00 at midnight and the day will change. At that time, a 12 hour clock shows 12 midnight.

Study the following table to see how different times of the day are shown in the 12 hour and 24 hour clocks.

12 hour clock	24 hour clock	12 hour clock	24 hour clock
0:05 am	 00:05	12:05 pm	 12:05
5 minutes past 12 midnight		5 minutes past 12 noon	
1:20 am	 01:20	1:20 pm	 13:20
20 minutes past 1 during night time		20 minutes past 1 in the afternoon	
6:55 am	 06:55	6:55 pm	 18:55
55 minutes past 6 in the morning		55 minutes past 6 in the evening	
10:15 am	 10:15	10:15 pm	 22:15
15 minutes past 10 in the morning		15 minutes past 10 in the evening	
12:00	 12:00	12:00	 00:00 means 24:00
12 noon		12 midnight	

The timetables of some trains going from Badnera to Nagpur are given below. Observe the use of the 24 hour clock in the timetable.

Name of the train	Train number	Departure time	Arrival time
Howrah Mail	12809	07:45	11:05
Shalimar Express	18024	09:45	13:10
Mumbai Mail	21028	13:05	17:20
Malda Town Express	13426	23:10	01:55

Problem Set 44

1. The time below is given by the 12 hour clock. Write the same by the 24 hour clock.

30 minutes past 10 in the morning 10 minutes past 8 in the morning
 20 minutes past 1 in the afternoon 40 minutes past 5 in the evening

2. Match the following.

12 hour clock

9:10 am

2:10 pm

5:25 pm

11:10 pm

7:25 am

24 hour clock

23:10

7:25

14:10

9:10

17:25

Examples of time measurement

Example (1) If Abdul started working on the computer at 11 in the morning and finished his work at 3:30 in the afternoon, how long did he work ?

Method 1 : From 11 in the morning to 12 noon, it is 1 hour. From 12 noon to 3:30 in the afternoon, it is 3 hours and 30 minutes. Therefore, the total time is 4 hours and 30 minutes.

Method 2 : According to the 24 hour clock, 11'o'clock in the morning is 11:00 and 3:30 in the afternoon is 15:30.

Hr	Min
15	30
- 11	00
4	30

Abdul worked for a total of 4 hours and thirty minutes, or four and a half hours.

Example (2) Add :

4 hours 30 min + 2 hours 45 min

Hr	Min
4	30
+ 2	45
6	75
7	15

75 min
= 1 hour 15 min

Example (3) Subtract :

5 hr 30 min - 2 hr 45 min

Hr	Min
4	60 + 30
5	30
- 2	45
2	45

45 minutes cannot be subtracted from 30 minutes. Therefore, we borrow 1 hour and convert it into 60 minutes for the subtraction.

Example (4) Amruta travelled by bus for 3 hours 40 minutes and by motorcycle for 1 hour 45 minutes. How long did she spend travelling ?

Hr	Min
3	40
+	1 45
4	85
5	25

Travel time by bus

Travel time by motorcycle

Total travel time

(60 + 25) minutes are 85 minutes,
that is, 1 hour and 25 minutes.

Let us add this 1 hour to 4 hours.

Therefore, Amruta travelled for a total of 5 hours and 25 minutes.

Problem Set 45

1. Add the following :

- (1) 2 hours 30 minutes + 4 hours 55 minutes
- (2) 3 hours 50 minutes + 4 hours 20 minutes
- (3) 3 hours 45 minutes + 1 hour 35 minutes
- (4) 4 hours 15 minutes + 2 hours 50 minutes

2. Subtract the following :

- (1) 3 hours 10 minutes – 2 hours 40 minutes
- (2) 5 hours 20 minutes – 2 hours 35 minutes
- (3) 4 hours 25 minutes – 1 hour 55 minutes
- (4) 6 hours 15 minutes – 2 hours 45 minutes

3. A government office opens at 7 in the morning and closes at 3 in the afternoon. How long is this office open ?

4. A movie starts at 45 minutes past 3 in the afternoon and finishes two and a half hours later. At what time does the movie end ?

5. Sakharam was ploughing the field from 8 in the morning. At 12:30 in the afternoon he stopped and started for home. He reached home at 1:30. How long was he ploughing the field ? How long did it take him to reach home from the field ?

6. Rambhau started the water pump at ten thirty at night and put it off the same night at a quarter to twelve. How long was the water pump on ?

7. Geeta taught in the classroom for 2 hours and 25 minutes in the morning and 1 hour and 45 minutes in the afternoon. How long was she teaching in all ?

8. If a bank is open for business from 10 in the morning to 4:30 in the evening, how long is it open ?

9. If a shop is open from 9:30 am to 10 pm, how long is it open ?

10. If the Maharashtra Express leaving from Kolhapur at 15:30 arrives at Gondia the next day at 20:15, how long is the journey from Kolhapur to Gondia ?



11. Problems on Measurement

We use the units metre, gram and litre every day to measure length, mass and capacity respectively. While shopping, we use the units rupees and paise. We use units like days, hours and minutes to measure time. Let us see how to carry out basic operations like addition, subtraction, multiplication and division using these units of measurement.

Example (1) Add.

$$37 \text{ km } 250 \text{ m} + 15 \text{ km } 950 \text{ m}$$

km	m
11	
37	250
+	
15	950
53	200

$$250 + 950 = 1200$$

$$1200 \text{ m}$$

$$= 1 \text{ km} + 200 \text{ m}$$

53 km 200 m

Example (2) Subtract.

$$7 \text{ l } 150 \text{ ml} - 2 \text{ l } 500 \text{ ml}$$

l	ml
6	1150
7	150
-	
2	500
4	650

We cannot subtract 500 ml from 150 ml.

Convert 1 l into 1000 ml.

4 l 650 ml

Problem Set 46

1. Add :

(1) ₹ 9, 50 paise + ₹ 14, 60 paise

(3) 22 m 50 cm + 25 m 75 cm

(5) 25 kg 650 g + 29 kg 770 g

(2) 6 cm 5 mm + 7 cm 9 mm

(4) 15 km 740 m + 13 km 950 m

(6) 19 l 840 ml + 25 l 250 ml

2. Subtract :

(1) ₹ 19, 50 paise - ₹ 12, 60 paise

(3) 20 m 30 cm - 17 m 60 cm

(5) 35 kg 150 g - 26 kg 470 g

(2) 24 cm 2 mm - 3 cm 8 mm

(4) 40 km 255 m - 17 km 960 m

(6) 46 l 200 ml - 38 l 750 ml

Word problems

Study the following examples.

Example (1) If a shopkeeper has 150 kg 500 g of rice and sells 75 kg 750 g, how much rice will be left?

74 kg 750 g of rice is left.

kg	gm
149	1500
150	500
-	
75	750
74	750

Example (2) A can of milk has $20\text{ l } 450\text{ ml}$ of milk. Another can has $18\text{ l } 800\text{ ml}$. How much milk is there in the two cans altogether?

The total quantity of milk is $39\text{ l } 250\text{ ml}$.

<i>l</i>	<i>ml</i>
1	
20	450
+ 18	800
39	250

Example (3) At a speed of 90 km per hour, what distance will a train cover in two and a half hours?

The speed of the train is 90 kmph. That is, it travels 90 km in one hour. It travels 90 more km in the second hour.

In the next half an hour, $90 \div 2 = 45$ km

The total distance travelled is $90 + 90 + 45 = 225$ km.

Example (4) If one dress requires 3 m 25 cm of cloth, how much do 4 dresses need?

Manju's method:

3 m	25 cm	for the 1st dress	
+	3 m	25 cm	for the 2nd dress
+	3 m	25 cm	for the 3rd dress
+	3 m	25 cm	for the 4th dress
12 m		100 cm	

1 m is 100 cm, therefore $12 + 1 = 13$ m

Kunal's method :

	m	cm
	3	25
×		4
12		100

$12\text{ m } 100\text{ cm} = 13\text{ m}$

Example (5) If a wire that is 9 m 50 cm long is cut into pieces of 5 cm each, how many pieces will be made?

$9\text{ m } 50\text{ cm} = (900 + 50)\text{ cm}$

To find out how many pieces of 5 cm can be made from a wire 950 cm long, let us use division.

190 pieces will be made.

	190
5	950
	- 5
	45
	- 45
	000
	- 0
	0

Example (6) A play started at 30 minutes past 6 in the evening and finished two and three quarter hours later. What time did the play get over?

	Hr	Min	
	6	30	$75\text{ min} = 60\text{ min} + 15\text{ min}$
+	2	45	$= 1\text{ hr} + 15\text{ min}$
8		75	$8\text{ hr} + 1\text{ hr } 15\text{ min} = 9\text{ hr } 15\text{ min}$

The play got over at 15 minutes past 9 at night.

Note : The units for length, mass and capacity are written in decimal form. This makes it easy to carry out addition and subtraction of length, mass and capacity.

Units of measuring time are not in decimal form. It is a little more difficult to carry out additions and subtractions of those quantities.

Problem Set 47

1. For his birthday, Ajay gave $20\text{ l } 450\text{ ml}$ of milk to the children in an Ashramshala and $28\text{ l } 800\text{ ml}$ to the children in an orphanage. How much milk did Ajay donate?
2. Under the Rural Cleanliness Mission, college students cleaned $1\text{ km } 750\text{ m}$ of a village road that is $2\text{ km } 575\text{ m}$ long. How much remained to be cleaned?
3. Babhulgaon used 21,250 litres of treated waste water in the fields. Samvatsar used 31,350 litres of similar water. How much treated waste water was used in all?
4. If half a litre of milk costs 22 rupees, how much will 7 litres cost?
5. If the speed of a motorcycle is 40 km per hour, how far will it travel in an hour and a quarter?
6. If a man walks at a speed of 4 kmph, how long will it take him to walk 3 km?
7. If a rickshaw travels at a speed of 30 kmph, how far will it travel in three quarters of an hour?
8. During Cleanliness Week, children cleaned the public park in their town. They collected three quarter kilograms of plastic bags and five and a half kilograms of other garbage. How much garbage did they collect in all?
9. If one shirt needs $2\text{ m } 50\text{ cm}$ of cloth, how much cloth do we need for 5 shirts?
10. If a car travels 60 km in an hour, how far will it travel in
 - (1) 2 hours?
 - (2) 15 minutes?
 - (3) half an hour?
 - (4) three and a half hours?
11. If one gold bangle is made from 12 grams 250 milligrams of gold, how much gold will be needed to make 8 such bangles? ($1000\text{ mg} = 1\text{ g}$)
12. How many pouches of 20g cloves each can be made from $1\text{ kg } 240\text{ g}$ of cloves?
13. Seema's mother bought $2\text{ m } 70\text{ cm}$ of cloth for a kurta and $2\text{ m } 40\text{ cm}$ for a shirt. How much cloth did she buy in all?
14. A water tank holds 125 l of water. If $97\text{ l } 500\text{ ml}$ of the water is used, how much water remains in the tank?
15. Harminder bought $57\text{ kg } 500\text{ g}$ of wheat from one shop and $36\text{ kg } 800\text{ g}$ of wheat from another shop. How much wheat did he buy altogether?
16. Renu took part in a 100m race. She tripped and fell after running $80\text{ m } 50\text{ cm}$. How much distance did she have left to run?

17. A sack had 40kg 300 grams of vegetables. There were 17kg 700g potatoes, 13kg 400g cabbage and the rest were onions. What was the weight of the onions?
18. One day, Gurminder Singh walked 3km 750m and Parminder Singh walked 2km 825m. Who walked farther and by how much?
19. Suresh bought 3kg 250g of tomatoes, 2kg 500g of peas and 1kg 750g of cauliflower. How much was the total weight of the vegetables he bought?
20. Jalgaon, Bhusawal, Akola, Amravati and Nagpur lie serially on a certain route. The distances between Akola and these other places are given below. Use them to make word problems and solve the problems.
Amravati - 95 km, Bhusawal - 154 km, Nagpur - 249 km, Jalgaon - 181 km

21. Complete the following table and prepare the total bill.

Foodstuff	Weight (kg)	Rate (₹ per kg)	Cost
Sugar	2.5	32	
Rice	4.0	35	
Chana Dal	1.5	60	
Toor Dal	3.0	70	
Wheat	7.0	21	
Oil	1.5	110	
Total			

Activity

- You have 1 kg of potatoes. Find out which other ingredients you will need to make *potato vadas* and approximately how much of each ingredient you will need. Also find out approximately how much each ingredient will cost and how many *vadas* you will be able to make.
- Fix a 1 m long stick in an open field. Measure the shadow of the stick at 9:00 in the morning, at 12:00 noon, at 3:00 in the afternoon and at 5:00 in the evening. Observe at which time of the day the shadow is shortest and at what time, it is longest.
- Measure the length of a pen refill.



12. Perimeter and Area



□ Perimeter : Revision

Closed figures have a perimeter. You know that the sum of the lengths of all the sides of a figure is called its perimeter.

Fill in the empty boxes in the following problems.

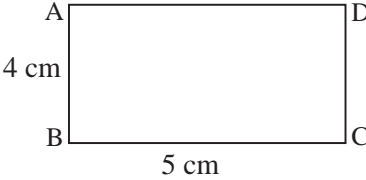
1.  The lengths of the adjacent sides of rectangle ABCD are given.
The perimeter of rectangle ABCD is cm.
Remember, the lengths of the opposite sides of a rectangle are equal.

2. The length of the adjacent sides of a rectangle are 10 cm and 7 cm. The perimeter of the rectangle is cm.

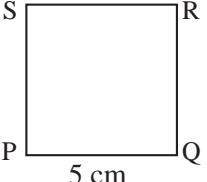
3.  The length of a side of square PQRS is 5 cm.
The perimeter of square PQRS is cm.

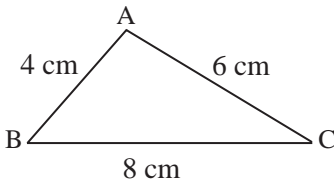
4.  In triangle ABC, the length of side AB is 4 cm, the length of BC is 8 cm and the length of CA is 6 cm. The perimeter of triangle ABC is cm.

Problem Set 48

1. Write the perimeter of each figure in the box given below it.

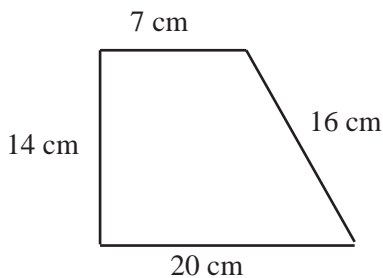

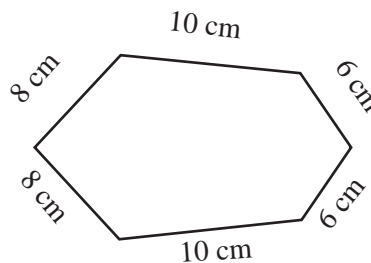

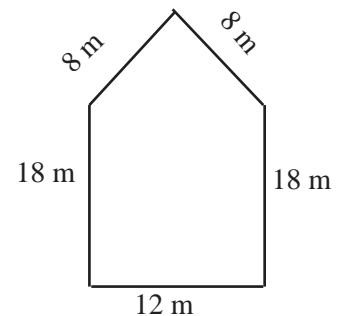

2. If a square of side 1 cm is cut out of the corner of a larger square with side 3 cm (see the figure), what will be the perimeter of the remaining shape?

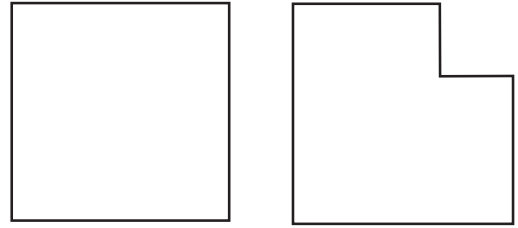

□ Formula for the perimeter of a rectangle

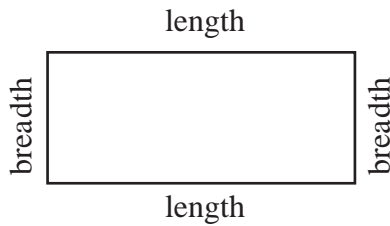

Perimeter = length + breadth + length + breadth

Opposite sides of a rectangle are of the same length.

So, the perimeter of a rectangle

= twice the length + twice the breadth

= $2 \times \text{length} + 2 \times \text{breadth}$

Perimeter of a rectangle = $2 \times \text{length} + 2 \times \text{breadth}$

Example : The length of the rectangle below is 7 cm and its breadth, 3 cm. Let us find its perimeter.

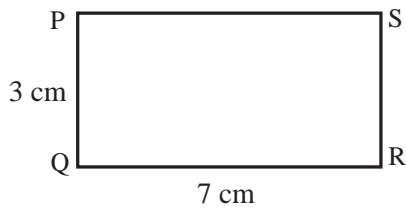

Perimeter of rectangle PQRS = $2 \times \text{length} + 2 \times \text{breadth}$

$$= 2 \times 7 + 2 \times 3$$

$$= 14 + 6$$

$$= 20$$

Therefore, the perimeter of the rectangle is 20 cm.

□ Formula for the perimeter of a square

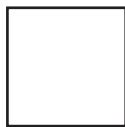

The lengths of all the sides of a square are equal. Therefore, the perimeter of a square = four times the length of one of its sides.

Perimeter of a square = $4 \times \text{the length of one side}$

Example : The length of one side of a square is 6 cm. Find its perimeter.

The perimeter of a square is four times the length of one side.

Perimeter of a square = $4 \times \text{length of one side}$

$$= 4 \times 6$$

$$= 24$$

Therefore, the perimeter of the square is 24 cm.

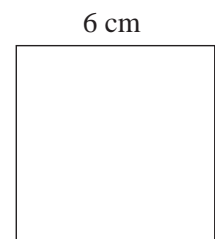

□ Word problems

Example (1) The length of a rectangular park is 100 m, while its width is 80 m. What is its perimeter ?

$$\begin{aligned}\text{Perimeter of the rectangle} &= 2 \times \text{length} + 2 \times \text{breadth} \\ &= 2 \times 100 + 2 \times 80 \\ &= 200 + 160 \\ &= 360\end{aligned}$$

The perimeter of the rectangular park is 360 m.

Example (2) How much wire will be needed to put a triple fence around a square plot with side 30 m? What will be the total cost of the wire at ₹ 70 per metre ?

To put a single fence around the square plot, we need to find its perimeter.

$$\text{Perimeter of a square} = 4 \times \text{length of one side} = 4 \times 30 = 120$$

The perimeter of the square plot is 120 metres. Since the fence is to be a triple fence, we must triple the perimeter.

$$120 \times 3 = 360 \text{ m of wire will be needed.}$$

Now let us find out how much the wire will cost. One metre of wire costs ₹ 70. Therefore, the cost of 360 m of wire will be $360 \times 70 = 25,200$.

The total cost of wire for putting a triple fence around the plot will be ₹ 25,200.

Problem Set 49

- How much wire will be needed to make a rectangle 7 cm long and 4 cm wide ?
- If the length of a rectangle is 20 m and its width is 12 m, what is its perimeter ?
- Each side of a square is 9 m long. Find its perimeter.
- If we take 4 rounds around a field that is 160 m long and 90 m wide, what is the distance we walk in kilometres ?
- Sanju completes 12 rounds around a square park every day. If one side of the park is 120 m, find out in kilometres and metres the distance that Sanju covers daily.
- The length of a rectangular plot of land is 50 m and its width is 30 m. A triple fence has to be put along its edges. If the wire costs 60 rupees per metre, what will be the total cost of the wire needed for the fence ?
- A game requires its players to run around a square playground. Each side of the playground is 20 m long. One player took 5 rounds around the playground. How many metres did he run altogether ?
- Four rounds of wire fence have to be put around a field. If the field is 60 m long and 40 m wide, how much wire will be needed ?
- The sides of a triangle are 24.7 cm, 20.4 cm and 10.5 cm respectively. What is the perimeter of the triangle ?

10. Look at the figures on the sheet of graph paper. Measure their sides with the help of the lines on the graph paper. Write the perimeter of each in the right box.

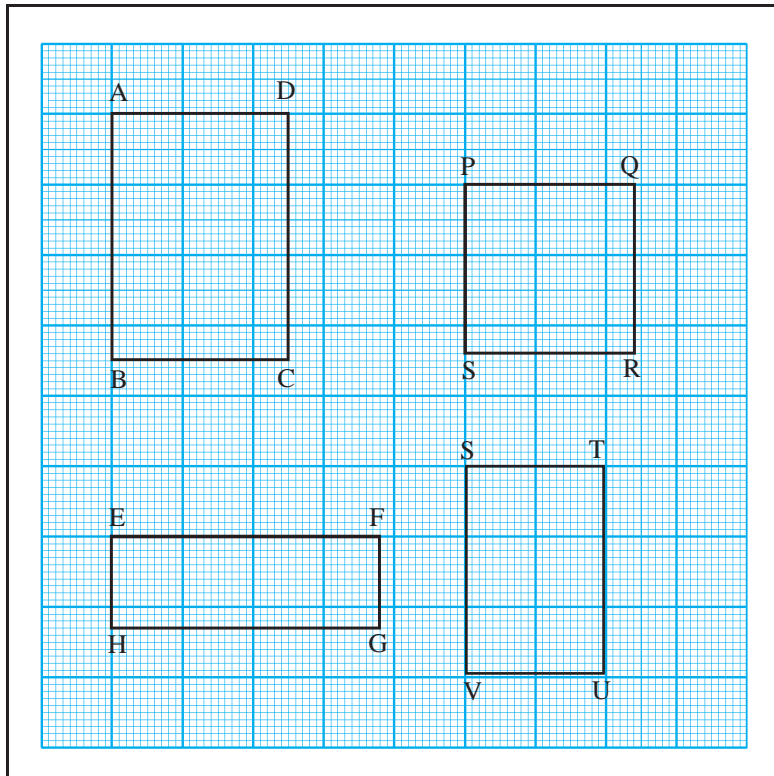

(1) Perimeter of rectangle ABCD
= cm

(2) Perimeter of rectangle EFGH
= cm

(3) Perimeter of square PQRS
= cm

(4) Perimeter of rectangle STUV
= cm

Area : Revision

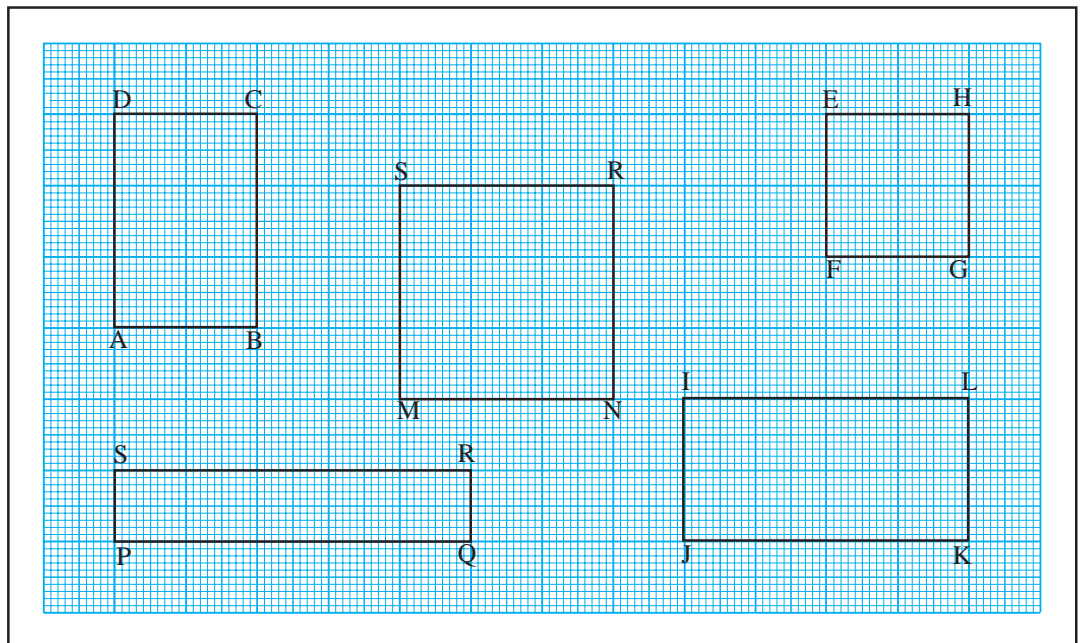

Of the figures given above, figure ABCD has six squares of 1 cm each inside it. It means that its area is 6 sq cm.

In the same way, count the squares in each figure and write its area.

- (1) Area of MNRS = sq cm (2) Area of EFGH = sq cm
 (3) Area of PQRS = sq cm (4) Area of IJKL = sq cm

Atul : Sir, why is the unit for area written as sq cm? We measure the sides in centimetres.

Teacher : Centimetre is a standard unit of length. In order to measure area, we need a standard unit of area. For this, a square with a side 1 cm is taken as the standard unit. The area of this square is 1 square centimetre. That is why this unit is written as sq cm, in short.

To measure large areas like fields, parks and playgrounds, a square with side 1 m, that is, an area of 1 sq m, is taken as the standard unit.

To measure the areas of *talukas* or districts, a square with side 1 km, or 1 sq km is the standard unit used.

□ Formula for the area of a rectangle

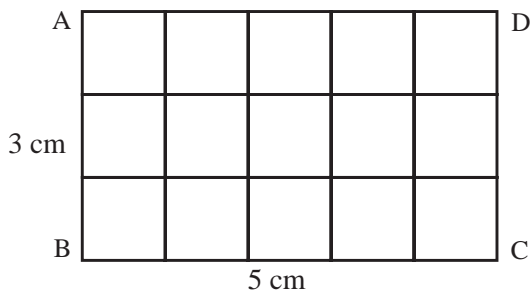

(1) In the rectangle ABCD given alongside, 1 cm divisions were marked off on each side. The points on opposite sides were joined as shown in the figure. The length of the sides of each square thus created is 1 cm. Therefore, the area of each square is 1 sq cm.

In ABCD, 3 rows with 5 squares each have been created.

The number of squares in rectangle ABCD is $3 \times 5 = 15$.

Therefore, the area of rectangle ABCD is 15 sq cm.

Here, the length of the figure is 5 cm and its breadth is 3 cm.

Note that the product of 3 and 5 is 15.

(2) In the rectangle with sides 4 cm and 2 cm, make squares of 1 sq cm each as shown above. Count the number of squares.

Note that here too, the number of squares formed are the same as the product of the length and width of the rectangle.



Therefore, **The area of a rectangle = length \times breadth**

□ Formula for the area of a square

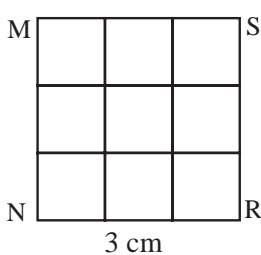

(1) Look at the square given alongside. The side of the square is 3 cm long. 9 squares of 1 cm each are formed within this square. Therefore, the area of this square is 9 sq cm.

Here, there are 3 rows with 3 squares each, i.e., there are $3 \times 3 = 9$ squares.

The length of each side of the square is 3 cm.

The product of two sides of the square is $3 \times 3 = 9$.

(2) Measure the area of a square with side 5 cm, in the same way.

The answer will be 25 sq cm.

Note that $5 \times 5 = 25$

Therefore, **The area of a square = length of a side \times length of a side**

It is not necessary to divide a square or rectangle into small squares every time you calculate their area. The advantage of a formula is that you can calculate the area simply by substituting the appropriate values.

□ Word problems

Example (1) What is the area of a rectangle of length 20 cm and width 15 cm ?

$$\begin{aligned}\text{Area of a rectangle} &= \text{length} \times \text{breadth} \\ &= 20 \times 15 = 300.\end{aligned}$$

Therefore, the area of the rectangle is 300 sq cm.

Example (2) A wall that is 4 m long and 3 m wide has to be painted. If the labour charges are ₹25 per sq m, what is the cost of labour for painting this wall ?

First let us calculate the area of the wall to be painted.

$$\text{Area of the wall} = \text{length of the wall} \times \text{breadth of the wall} = 4 \times 3 = 12$$

Thus, the area of the wall is 12 sq m.

Labour cost of 1 sq m is 25 rupees.

$$\text{So the labour cost for 12 sq m will be} = 12 \times 25 = 300$$

The cost of labour for painting the wall will be 300 rupees.

Example (3) What will be the area of a square with sides 15 cm ?

$$\begin{aligned}\text{Area of a square} &= \text{length of side} \times \text{length of side} \\ &= 15 \times 15 = 225\end{aligned}$$

The area of the square is 225 sq cm.

Example (4) One side of a square room is 4 m. If the cost of labour for laying 1 sq m of the floor is 35 rupees, what will be the total cost of labour ?

First we must find the area of the square room.

$$\text{Area of the square room} = \text{length of side} \times \text{length of side} = 4 \times 4 = 16$$

Therefore, the area of the square room is 16 sq m.

The labour cost of laying 1 sq m of flooring is 35 rupees.

Therefore, the cost of laying 16 sq m of flooring is $16 \times 35 = 560$ rupees.

Problem Set 50

1. The length of the side of each square is given below. Find its area.
 (1) 12 metres (2) 6 cm (3) 25 metres (4) 18 cm
2. If the cost of 1 sq m of a plot of land is 900 rupees, find the total cost of a plot of land that is 25 m long and 20 m broad.
3. The side of a square is 4 cm. The length of a rectangle is 8 cm and its width is 2 cm. Find the perimeter and area of both figures.
4. What will be the labour cost of laying the floor of an assembly hall that is 16 m long and 12 m wide if the cost of laying 1 sq m is 80 rupees?

5.

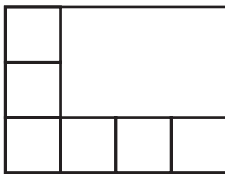

The picture alongside shows some squares. Find out how many squares with the same measures will fit in the empty space in the figure.

6.

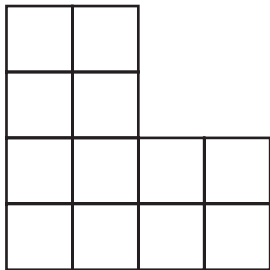

Divide the figure given alongside into four parts in such a way that the area and shape of each part is the same. Colour the parts with different colours.

Fair and square

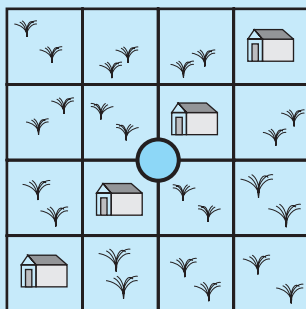

As shown in the figure alongside, a square plot of land owned by the government contains four houses and a well right in the centre. The government has to divide the houses and the land between four poor persons according to the following conditions.

- (1) Each person must get only one house.
- (2) The shape and area of the land must be the same.
- (3) Each person must be able to use the well without trespassing on any one else's land.

Show the appropriate divisions in four different colours.

Activity

Using a graph paper, find out the area of different rectangles and squares.



13. Three Dimensional Objects and Nets



□ Two dimensional drawings of three dimensional objects

Tai pointed to an object on a slightly high table and asked.

Tai : What is that ?

Sharad : That's a card which has a nice picture of *laddoos*.

Tai : Since you're looking at it from the front, it appears to be a card. Let me turn it around a little and put it on the floor.



Sheela : I thought it was just a nice picture on a card. But the picture is actually pasted on a box.



Tai : At first, you only saw the front surface. Now, when you look from above and from a different angle, you can see three different surfaces and you can also see that it is actually a three dimensional box.



Sharad : What does three dimensional mean ?

Tai : Three dimensional objects are objects whose length, width and height can be seen, felt or measured. Books, glasses and tables are some three dimensional objects. Objects which have only length and breadth and no thickness or negligible thickness can be called two dimensional objects. Sheets of paper, pictures on paper and shadows are some examples of two dimensional figures.

Sheela : Actually, objects are three dimensional. Their pictures on paper are two dimensional.

Sharad : That is why, some pictures seem flat. But some pictures are drawn in such a way that we can sense the depth or thickness of the objects.

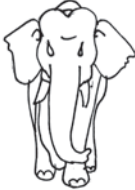
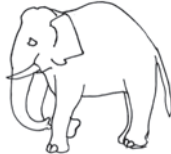
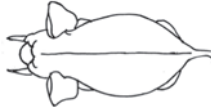
Tai : Let me show you a chart. It shows how three dimensional objects appear when seen from the front, from the side and from above. Study it carefully.

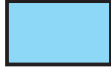
Object	The object as seen –		
	from the front	from one side	from above
Elephant			
Cupboard			

Looking at hills in the distance, we can see how tall and broad they are. But, we cannot tell how much area they occupy on the ground. One has to go up and above them in a helicopter to see how much area they occupy on land. But then, from there we cannot see how high they are. Therefore, to show the area over which a hill is spread and also how high it is in its different parts, two figures like those below are drawn.

In figure 1, we see hills as from a distance. The lines show their approximate heights. Figure 2 shows the extent of land they occupy as seen from above and the curved lines show their different heights in different parts. For example, the line that shows 800 m indicates a height of about 800 m.

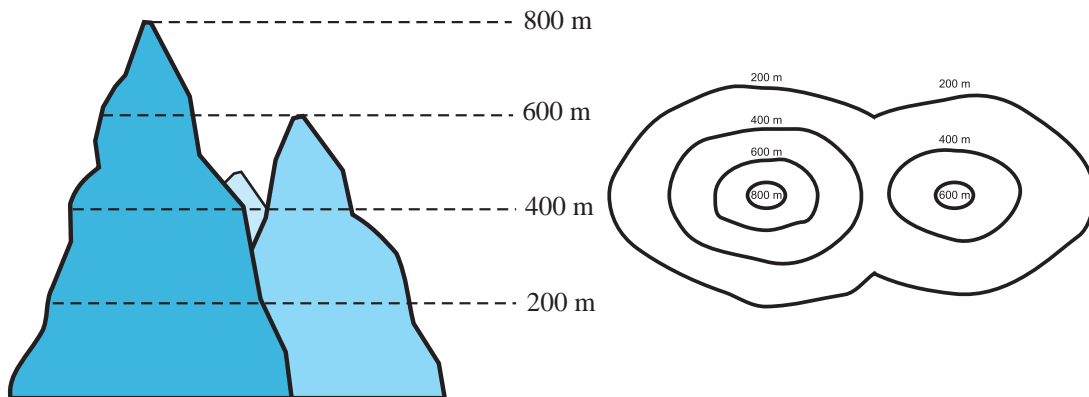

In Geography, such diagrams are used to show mountains on maps.

Problem Set 51

- The first column shows a structure made of blocks. The other columns show different views of the structure in two dimensions. Say whether each view is from the front, from a side or from above.

	Block formations	View of formations		
(1)				
(2)				
(3)				

- Draw three pictures of each of these three dimensional objects – a table, a chair and a water-bottle as viewed from the front, from a side and from above.

□ Nets

Last year we saw that cutting some edges of a box and laying it out flat gives us the net from which it was made.

The two dimensional shape from which a three dimensional object can be made by folding is called the 'net' of that object.

(1) By folding the cardboard shown below, along the lines shown in it, we get a three dimensional object (box). In this shape, all surfaces are square.

An object of this shape is called a cube.

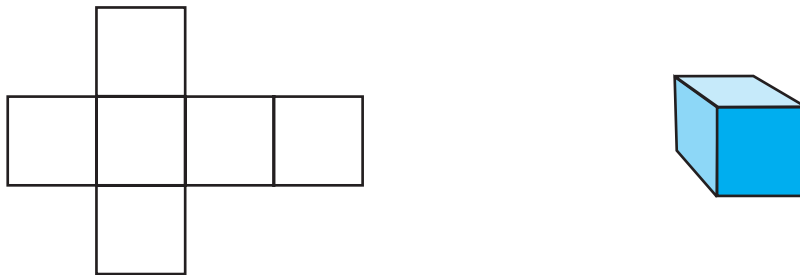

(2) The net of another cardboard box is shown in the figure below. By folding along the lines in this net and joining the edges to each other, we can see that a three dimensional box is formed. The surfaces of this box are rectangular in shape.

An object of this shape is called a cuboid.

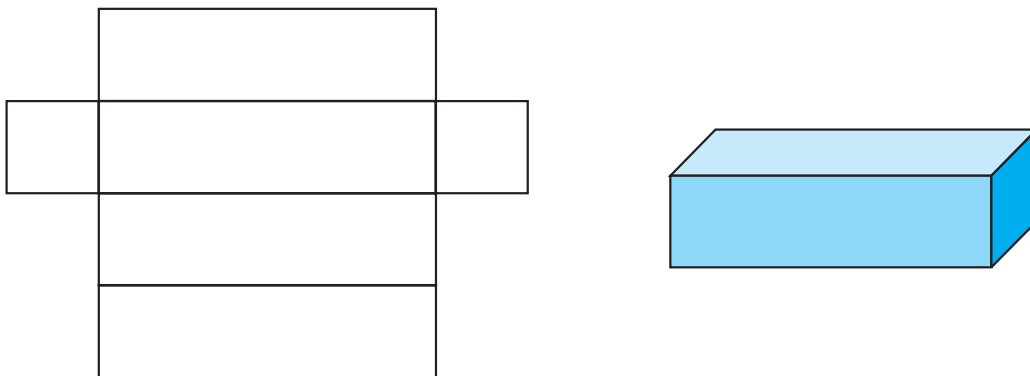

Activity : Draw the nets shown below on card sheet. Cut out the shapes and find out the shapes of the boxes they form.

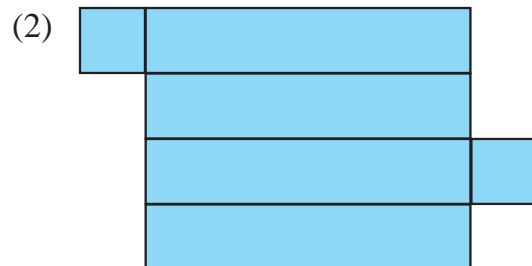
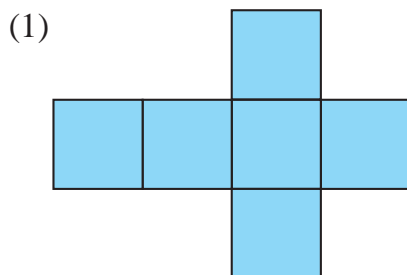

□ A five-square net (Pentomino)

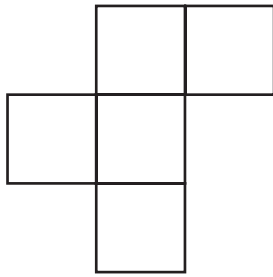

In the figure alongside, five squares of the same size are placed together with their sides joined.

Such an arrangement of five squares is called a 'five-square net' or a 'pentomino'.

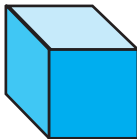

By folding along the edges of such a five-square net, an open box is formed.

Activity : Some five-square nets are given below. Draw these nets on a card sheet. Make open boxes from these nets.

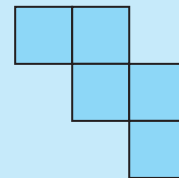
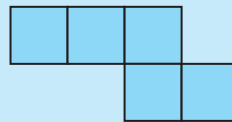
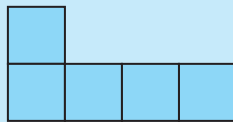

Try to find out other five-square nets that can be used to make open boxes.

A riddle

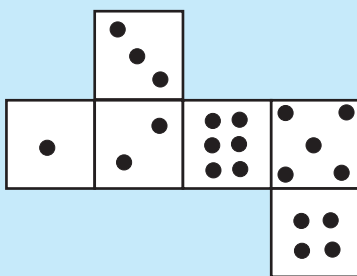

The net of a cube-shaped dice is given alongside. If a dice is made of this net, which of the following shapes will it definitely *not* resemble?

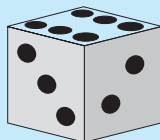

(1)

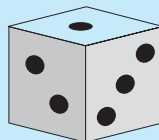

(2)

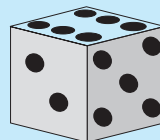

(3)

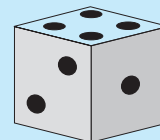

(4)

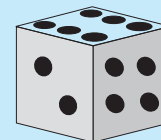



(5)



14. Pictographs



The table below gives some bowling figures related to a cricket match.

Bowler	Overs	Runs given	Wickets taken
Chandrakant		18	4
Ramakant		20	–
Ahmed		12	2

Scale: 1 picture = 1 over (6 balls)

Answer the following questions by referring to the table above.

- | | |
|--|---|
| <p>(1) About how many bowlers does the table give information?</p> <p>(3) How many overs did Chandrakant bowl?</p> <p>(5) How many balls did Ahmed bowl?</p> <p>(7) How many overs were bowled altogether?</p> | <p>(2) Who gave away the most runs?</p> <p>(4) How many wickets did Ramakant take?</p> <p>(6) How many runs did Chandrakant give?</p> <p>(8) Who gave away the least runs per over?</p> |
|--|---|

Thus, we can see that a lot of information can be obtained from the pictures in this table. Such tables which represent information using pictures or icons are called **pictographs** or **pictograms**.

▣ Pictorial representation of numerical data



Example (1) During a survey, the numbers of students living in different types of houses were listed as shown below.

Type of house	Number of students
Bungalow	4
Apartment	20
Row House	8

Let us make a pictograph based on this. For the cricket data, cricket balls were used. What icon shall we use for students? Surely, a smiley 😊 will be just right.

Should we draw 20 faces for 20 children ?

That is not necessary. It is easier to use an appropriate scale for the numbers in the information or data. For example, here all three numbers in the given data are divisible by 4. So, using one picture for 4 students, the students living in bungalows will be shown by 1 picture, those in apartments by 5, and those in row houses, by 2 pictures. After drawing the pictures, our pictograph will look like this :

Type of house	Number of students
Bungalow	
Apartment	
Row House	

Scale : 1 picture = 4 students

The aim of pictographs is to make numerical information easier to understand. Note that all the numbers given here are also divisible by 2. So, we could use a scale of 2 students per picture. In that case, the number of pictures will increase. As a result, it will not be as easy to understand the given numerical information.

To make a pictograph, we must –

- Study the numerical information given.
- Find out the factors of all the numbers to be represented.
- Choose an appropriate scale.
- Choose an appropriate symbol.
- Make the right columns for the pictograph.
- Below the pictograph, write the scale used.





Example (2) Information collected from 150 students about their parents' occupations is given below. Make a pictograph based on it.

Occupations of students' parents	Number of students
Farming	60
Private Job	20
Government Job	30
Other	40

All the given numbers can be divided by 2, 5 and 10. '1 picture for 10 students' will be a convenient scale. So, we will draw 6 pictures for 60 students, 2 for 20, 3 for 30 and 4 for 40 students.

Keeping in mind the type of information, this picture  will be appropriate.

Our pictograph will look like the one given below.

Occupations of students' parents	Number of students
Farming	
Private Job	
Government Job	
Other	

Scale: 1 picture = 10 students

Problem Set 52

- Stocks of various types of grains stored in a warehouse are as given below. Make a pictograph based on the information given.

Grain	Sacks
Rice	40
Wheat	56
Bajra	8
Jowar	32

2. Information about the various types of vehicles in Wadgaon is given below. Make a pictograph for this data.

Types of vehicles	Number
Bicycles	84
Automatic two-wheelers	60
Four-wheelers (cars/jeeps)	24
Heavy vehicles (truck, bus, etc.)	12
Tractors	24

3. The numbers of the various books kept in a cupboard in the school library are given below. Make a pictograph showing the information given.

Type of book	Number
Science	28
Sports	14
Poetry	21
Literature	35
History	7

Activity

Collect information based on the points given below and make a pictograph for each.

- (1) Which crops are grown on the farms owned by students in your class? (Vegetables, grains, pulses, fruits, etc.)
- (2) Which storybooks do your classmates like? (fairytale, stories about kings and queens, historical stories, stories about saints, picture stories, etc.)
- (3) What do your classmates want to be when they grow up? (doctor, teacher, farmer, engineer, officer, etc.)



15. Patterns



Tai : How nice ! The dots for your *rangoli* are all at equal distances from each other. Do you see the maths hidden in these dots ?

Surekha : Maths in the dots? I did not see that.

Shabnam : I know what you mean, Tai. The dots are arranged in the form of a **square**.

Tai : You're absolutely right! Now tell me, how many dots are there?

Surekha : 4 dots in each row, and 4 rows. Therefore, there are $4 \times 4 = 16$ dots.

Tai : Good ! This means we can arrange 16 dots in a square. Which other numbers of dots can we arrange in a square ?

Shabnam : To make a square, each horizontal and vertical row needs to have an equal number of dots.

Surekha : That means $2 \times 2 = 4$; $3 \times 3 = 9$; if we take a number obtained by multiplying another number by itself, we can put the dots in a square arrangement.

Tai : Exactly ! 4, 9, 16, 25 or 36 are the numbers of dots that we can put in a square arrangement. These numbers are called **square numbers**. Is 100 a square number ?

Surekha : Ten tens are 100. This means that 100 is a square number.

Tai : Correct ! And 40 ?

Shabnam : Let me think. $6 \times 6 = 36$; $7 \times 7 = 49$ and 40 comes between 36 and 49. This means that there is no number that can be multiplied by itself to make 40. Therefore, 40 is not a square number.

Tai : Let me tell you one more fun thing about numbers. First, add numbers from 1 to 6 like this : $1 + 2$; $1 + 2 + 3$.

Surekha : $1 + 2 = 3$, $1 + 2 + 3 = 6$, $1 + 2 + 3 + 4 = 10$,
 $1 + 2 + 3 + 4 + 5 = 15$, $1 + 2 + 3 + 4 + 5 + 6 = 21$.

Tai : Let me draw dots equal to the numbers 3, 6, 10, 15 and 21 like this :

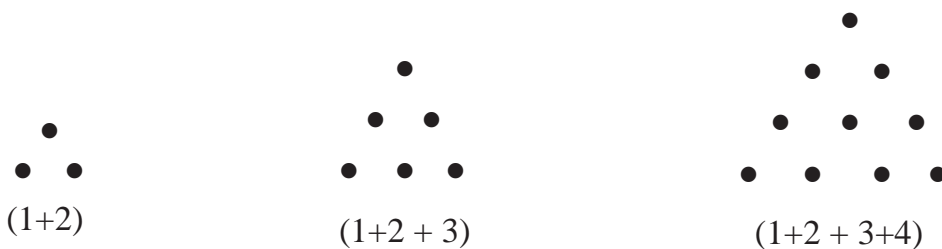

Shabnam : I've got it, Tai ! These arrangements of dots form triangles.

Tai : Right! And, can you see anything special about the triangles?

Surekha : All three sides of the triangles are equal.

Tai : Right, again! Now tell me, can we draw 15 dots in such an arrangement?

Shabnam : Yes, Tai. I can make a *rangoli* of 15 dots shaped like a triangle with equal sides.

Tai : Ok! Now make one with 21 dots.

Surekha : We just have to add 6 dots to the arrangement!

Tai : So, aren't numbers like 3, 6, 10, 15 and 21 fun? What will you call such numbers?

Shabnam : **Triangular numbers!**

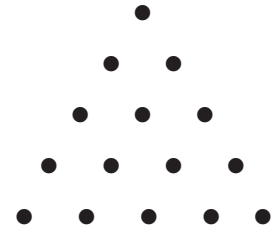

Tai : Correct. These numbers are actually called triangular numbers. We can find square and triangular numbers all around us. For example, in stacked bowls or pipes or on a chess board and so on.

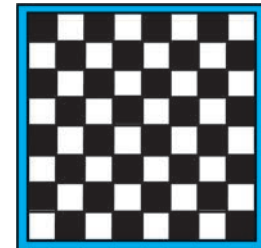
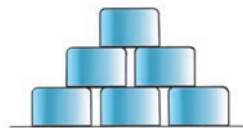
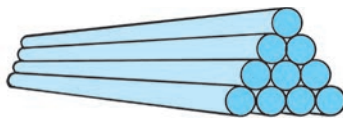

Problem Set 53

- Find the square numbers from the list given below.
5, 9, 12, 16, 50, 60, 64, 72, 80, 81
- Which are the triangular numbers in the given list?
3, 6, 8, 9, 12, 15, 16, 20, 21, 42
- Name a number which is square as well as triangular.
- If 4 is the first square number, which is the tenth one?
- If 3 is the first triangular number, which is the tenth one?

Think about it.

- How will you decide if a given number is a square number?
- How will you decide if a given number is a triangular number?
- How many square numbers do you think there are?
- How many triangular numbers do you think there are?

Activity

Make a collection of pictures in which you can see square or triangular numbers.

Patterns in floor tiles

The tiles in each picture below form a specific pattern. Observe that there is no gap or open ground between two tiles.

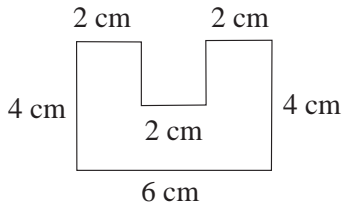
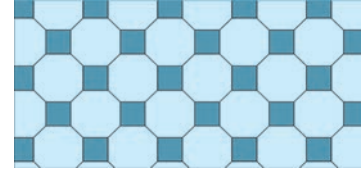
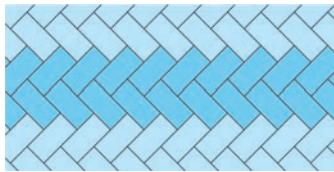

❖ On a large piece of card sheet, draw several shapes like the one shown alongside. Colour half of them. Cut them all out and separate them.

One pattern made of these shapes is shown alongside. Make some other patterns of your own.

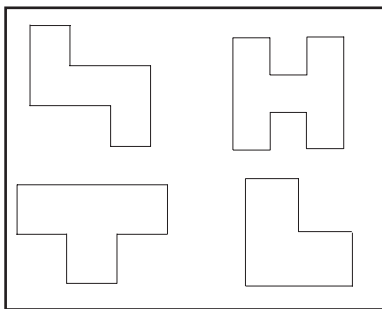
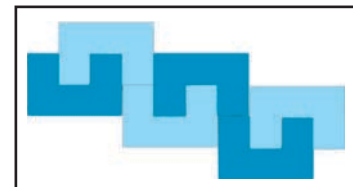

❖ Cut out many pieces of each of the shapes shown alongside. Join them in a pattern like floor tiles.

❖ Note the pattern and complete the design.

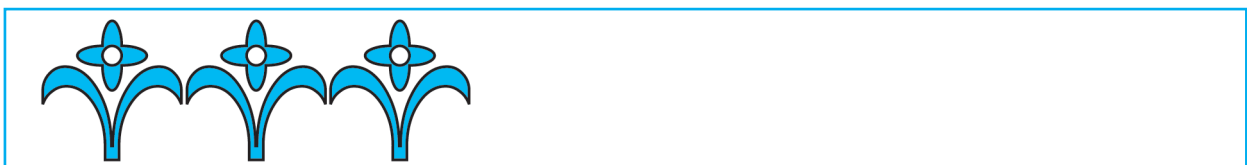
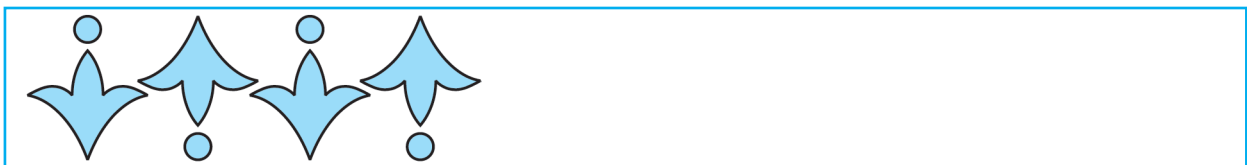
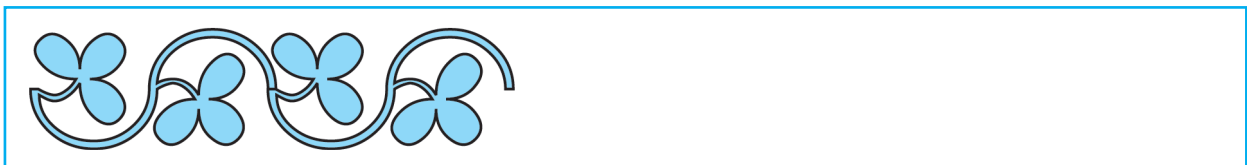

❖ Make your own shapes and use them to make patterns for *sari* and *shawl* borders, etc.

16. Preparation for Algebra

- Vidula** : Sir, my brother said he was studying Algebra. What is Algebra ?
- Sir** : To put it simply, algebra consists of the use of numbers and letters to state and solve problems.
- Ravi** : Does that mean addition and subtraction of letters? How do we do that?
- Sir** : To prepare for that, let's first learn a few things using numbers.

□ Equality

Whenever we add, subtract, multiply or divide two numbers, the answer we get is always another number. For example, when we add 5 and 3, we get the number 8. We write this as ' $5 + 3 = 8$ '. Similarly, $13 - 6 = 7$, $12 \div 4 = 3$, $9 \times 1 = 9$.

Now let us think about this in another way.

Suppose that by performing a mathematical operation on two numbers, we have obtained the number 12. Let us find pairs of such numbers. They could be $(6 + 6)$, $(15 - 3)$, (6×2) , $(24 \div 2)$, etc.

When we want to say 'a number obtained by adding six and six', it is easier to express it by using brackets like this : $(6 + 6)$

$(15 - 3)$ means 'a number obtained by subtracting 3 from 15'.

(6×2) means 'a number obtained by multiplying 6 by 2'.

$(24 \div 2)$ means 'a number obtained by dividing 24 by 2'.

Arrangements like $(6 + 6)$, $(15 - 3)$, (6×2) , $(24 \div 2)$ are called expressions. The value of each of these expressions is 12, which means all these expressions are equal to each other.

We can also write this as $(6 + 6) = (15 - 3)$, $(6 + 6) = (24 \div 2)$, $(6 \times 2) = (15 - 3)$.

An expression such as $(6 + 6) = (15 - 3)$ or $(6 + 6) = (24 \div 2)$ is called an '**equality**'.

$5 + 3 = 8$, $9 \times 1 = 9$ are also equalities.

Problem Set 54

- Using brackets, write three pairs of numbers whose sum is 13. Use them to write three equalities.
- Find four pairs of numbers, one for each of addition, subtraction, multiplication and division that make the number 18. Write the equalities for each of them.

□ Inequality

The values of $7 + 5$ and 7×5 are 12 and 35 respectively. It means that they are not equal. To represent 'not equal', the symbol ' \neq ' is used.

To show that $(7 + 5)$ and (7×5) are not equal, we write $(7 + 5) \neq (7 \times 5)$ in short.

This kind of representation is called an '**inequality**'.

$(9 - 5) \neq (15 \div 3)$ means that the expressions $(9 - 5)$ and $(15 \div 3)$ are not equal.

If two expressions are not equal, one of them is greater or smaller than the other. To show greater or lesser values, we use the symbols ' $<$ ' and ' $>$ '. Therefore, these symbols can also be used to show inequalities.

The value of $(9 - 5)$ is 4 and the value of $(15 \div 3)$ is 5. $4 < 5$, so the relation between $(9 - 5)$ and $(15 \div 3)$ can be shown as $(9 - 5) < (15 \div 3)$ or $(15 \div 3) > (9 - 5)$.

◆ Fill in the boxes between the expressions with $<$, $=$ or $>$ as required.

(1) $(9 + 8)$ $(30 \div 2)$
 $9 + 8 = 17$, $30 \div 2 = 15$
 $17 > 15$
Therefore $(9 + 8)$ $(30 \div 2)$

(2) (16×3) (4×12)
 $16 \times 3 = 48$, $4 \times 12 = 48$, $48 = 48$
Therefore (16×3) (4×12)

(3) $(16 - 5)$ (2×7)
 $16 - 5 = 11$, $2 \times 7 = 14$,
 $11 < 14$
Therefore $(16 - 5)$ (2×7)

◆ Write a number in the box that will make this statement correct.

(1) $(7 \times 2) = (\text{ } - 6)$

The value of the expression 7×2 is 14, so the number in the box has to be one that gives 14 when 6 is subtracted from it. Subtracting 6 from 20 gives us 14.

Therefore $(7 \times 2) = (\text{20} - 6)$

(2) $(24 \div 3) < (5 + \text{ })$

The value of the expression $24 \div 3$ is 8, so the number in the box has to be such that when it is added to 5, the sum is greater than 8.

Now, $5 + 1 = 6$, $5 + 2 = 7$, $5 + 3 = 8$. So the number in the box has to be greater than 3. Therefore, writing any number like 4, 5, 6 ... onwards will do. It means that this problem has several answers. $(24 \div 3) < (5 + \text{4})$ is one among many answers. Even if that is true, writing only one answer will be enough to complete this statement.

Problem Set 55

1. Say whether right or wrong.

(1) $(23 + 4) = (4 + 23)$ (2) $(9 + 4) > 12$ (3) $(9 + 4) < 12$ (4) $138 > 138$

(5) $138 < 138$ (6) $138 = 138$ (7) $(4 \times 7) = 30 - 2$ (8) $\frac{25}{5} > 5$
 (9) $(5 \times 8) = (8 \times 5)$ (10) $(16 + 0) = 0$ (11) $(16 + 0) = 16$ (12) $(9 + 4) = 12$

2. Fill in the blanks with the right symbol from $<$, $>$ or $=$.

(1) $(45 \div 9) \square (9 - 4)$ (2) $(6 + 1) \square (3 \times 2)$ (3) $(12 \times 2) \square (25 + 10)$

3. Fill in the blanks in the expressions with the proper numbers.

(1) $(1 \times 7) = (\square \times 1)$ (2) $(5 \times 4) > (7 \times \square)$ (3) $(48 \div 3) < (\square \times 5)$
 (4) $(0 + 1) > (5 \times \square)$ (5) $(35 \div 7) = (\square + \square)$ (6) $(6 - \square) < (2 + 3)$

Using letters

Symbols are frequently used in mathematical writing. The use of symbols makes the writing very short. For example, using symbols, 'Division of 75 by 15 gives us 5' can be written in short as ' $75 \div 15 = 5$ '. It is also easier to grasp.

Letters can be used like symbols to make our writing short and simple.

While adding, subtracting or carrying out other operations on numbers, you must have discovered many properties of the operations.

For example, what properties do you see in sums like $(9 + 4)$, $(4 + 9)$?

The sum of any two numbers and the sum obtained by reversing the order of the two numbers is the same.

Now see how much easier and faster it is to write this property using letters.

- Let us use a and b to represent any two numbers. Their sum will be ' $a + b$ '.

Changing the order of those numbers will make the addition ' $b + a$ '. Therefore, the rule will be: 'For all values of a and b , $(a + b) = (b + a)$.'

Let us see two more examples.

- Multiplying any number by 1 gives the number itself. In short, $a \times 1 = a$.
- Given two unequal numbers, the division of the first by the second is not the same as the division of the second by the first.

In short, if a and b are two different numbers, then $(a \div b) \neq (b \div a)$.

Take the value of a as 8 and b as 4 and verify the property yourself.

Problem Set 56

1. Use a letter for 'any number' and write the following properties in short.

- The sum of any number and zero is the number itself.
- The product of any two numbers and the product obtained after changing the order of those numbers is the same.
- The product of any number and zero is zero.

2. Write the following properties in words :

(1) $m - 0 = m$ (2) $n \div 1 = n$





Maharashtra State Bureau of Textbook Production and Curriculum Research, Pune.

इंग्रजी गणित इ.५ वी

₹ 36.00