

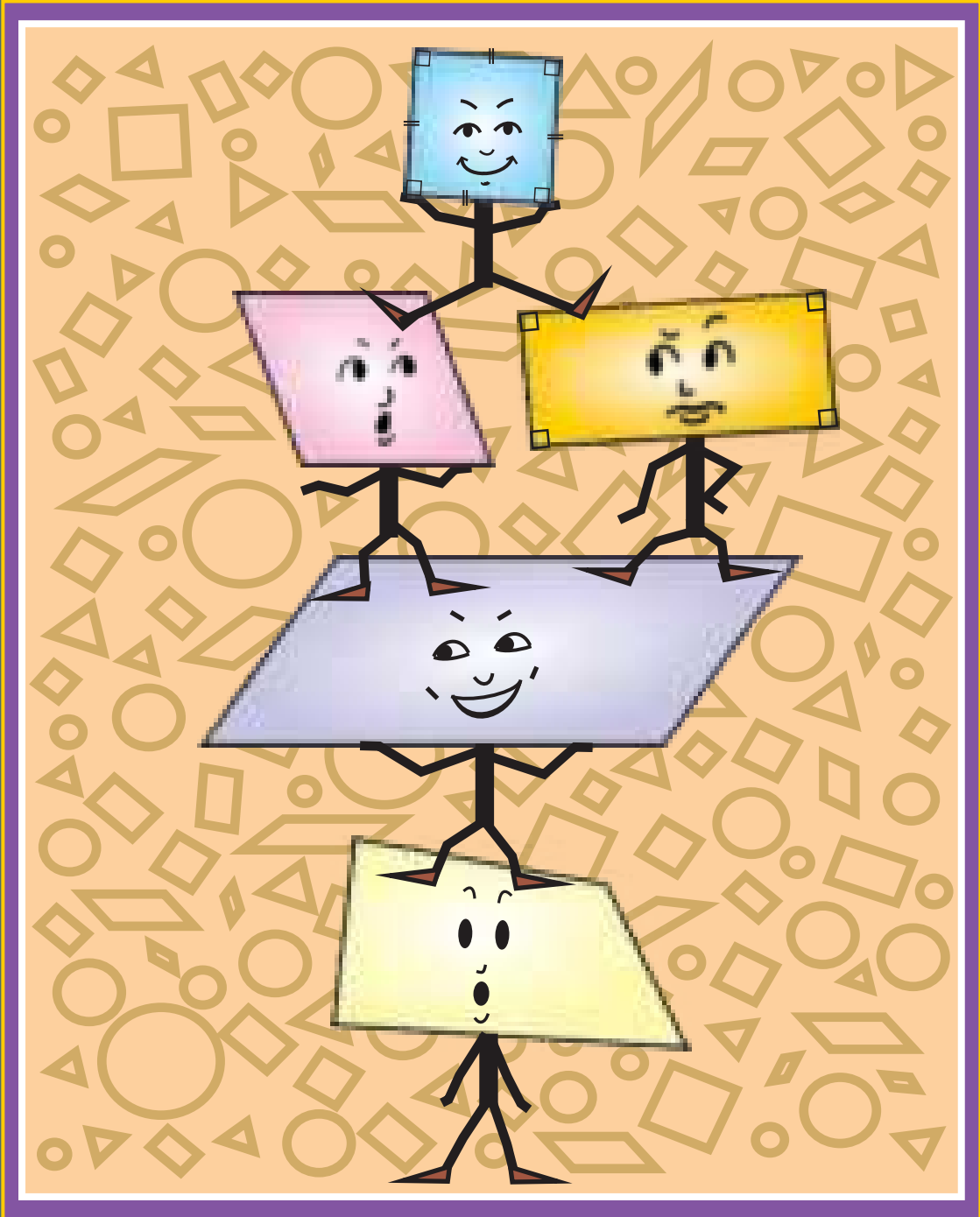

MATHEMATICS

STANDARD EIGHT



The Constitution of India

Chapter IV A

Fundamental Duties

ARTICLE 51A

Fundamental Duties- It shall be the duty of every citizen of India—

- (a) to abide by the Constitution and respect its ideals and institutions, the National Flag and the National Anthem;
- (b) to cherish and follow the noble ideals which inspired our national struggle for freedom;
- (c) to uphold and protect the sovereignty, unity and integrity of India;
- (d) to defend the country and render national service when called upon to do so;
- (e) to promote harmony and the spirit of common brotherhood amongst all the people of India transcending religious, linguistic and regional or sectional diversities, to renounce practices derogatory to the dignity of women;
- (f) to value and preserve the rich heritage of our composite culture;
- (g) to protect and improve the natural environment including forests, lakes, rivers and wild life and to have compassion for living creatures;
- (h) to develop the scientific temper, humanism and the spirit of inquiry and reform;
- (i) to safeguard public property and to abjure violence;
- (j) to strive towards excellence in all spheres of individual and collective activity so that the nation constantly rises to higher levels of endeavour and achievement;
- (k) who is a parent or guardian to provide opportunities for education to his child or, as the case may be, ward between the age of six and fourteen years.

The Coordination Committee formed by GR No. Abhyas - 2116/(Pra.Kra.43/16) SD - 4
Dated 25.4.2016 has given approval to prescribe this textbook in its meeting held on
29.12.2017 and it has been decided to implement it from the educational year 2018-19.

Mathematics

STANDARD EIGHT



**Maharashtra State Bureau of Textbook Production and
Curriculum Research, Pune - 411 004**

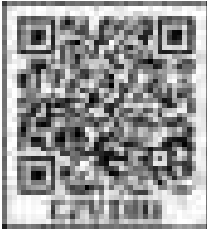

The digital textbook can be obtained through DIKSHA App on a smartphone by using the Q. R. Code given on title page of the textbook and useful audio-visual teaching-learning material of the relevant lesson will be available through the Q. R. Code given in each lesson of this textbook.

First Edition : 2018 © Maharashtra State Bureau of Textbook Production
Third Reprint : 2021 and Curriculum Research, Pune- 411 004.

Maharashtra State Bureau of Textbook Production and Curriculum Research reserves all rights relating to the book. No part of this book should be reproduced without the written permission of the Director, Maharashtra State Bureau of Textbook Production and Curriculum Research, Pune.

Mathematics Subject Committee

Dr Mangala Narlikar	(Chairman)
Dr Jayashri Atre	(Member)
Shri. Vinayak Godbole	(Member)
Smt. Prajakti Gokhale	(Member)
Shri. Ramakant Sarode	(Member)
Shri. Sandeep Panchbhai	(Member)
Smt. Pooja Jadhav	(Member)
Smt. Ujjwala Godbole	(Member-Secretary)

Cover, Illustrations and computer drawings

Shri. Sandeep Koli, Artist, Mumbai

Translation : Shri. V. D. Godbole

Smt. Jayashree Purandare

Dr. Jayashri Atre

Smt. Prajakti Gokhale

Scrutiny : Dr. Mangala Narlikar

Shri. V. D. Godbole

Co-ordinator

Ujjwala Shrikant Godbole

I/C Special Officer for Mathematics

Production

Sachchitanand Aphale
Chief Production Officer

Sanjay Kamble
Production Officer

Prashant Harne
Asst. Production Officer

Paper

70 GSM Cream wove

Print Order No.

N/PB/2021-22/1,00,000

Printer

LOKSHAHI OFFSET, JALGAON

Publisher

Vivek Uttam Gosavi, Controller
Maharashtra State Textbook Bureau,
Prabhadevi Mumbai- 400 025

Mathematics Study Group (State)

Smt. Jayashree Purandare	Smt. Taruben Popat
Shri. Rajendra Chaudhari	Shri. Pramod Thombare
Shri. Sandesh Sonawane	Dr. Bharati Sahasrabuddhe
Shri. Dnyaneshwar Mashalkar	Smt. Swati Dharmadhikari
Smt. Suvarna Deshpande	Shri. Pratap Kashid
Shri. Shripad Deshpande	Shri. Milind Bhakare
Shri. Suresh Date	Shri. Annapa Parit
Shri. Umesh Rele	Shri. Ganesh Kolte
Shri. Bansi Havale	Shri. Rama Vanyalkar
Smt. Rohini Shirke	Shri. Sudhir Patil
Shri. Prakash Zende	Shri. Prakash Kapse
Shri. Laxman Davankar	Shri. Ravindra Khandare
Shri. Shrikant Ratnaparakhi	Shri. Vasant Shewale
Shri. Sunil Shrivastav	Shri. Arvindkumar Tiwari
Shri. Ansari Abdul Hamid	Shri. Mallesham Bethi
Shri. Ansar Shaikh	Smt. Arya Bhide



The Constitution of India

Preamble

WE, THE PEOPLE OF INDIA, having solemnly resolved to constitute India into a SOVEREIGN SOCIALIST SECULAR DEMOCRATIC REPUBLIC and to secure to all its citizens :

JUSTICE, social, economic and political ;

LIBERTY of thought, expression, belief, faith and worship ;

EQUALITY of status and of opportunity ;
and to promote among them all

FRATERNITY assuring the dignity of the individual and the unity and integrity of the Nation ;

IN OUR CONSTITUENT ASSEMBLY this twenty-sixth day of November, 1949, do HEREBY ADOPT, ENACT AND GIVE TO OURSELVES THIS CONSTITUTION.

NATIONAL ANTHEM

Jana-gana-mana-adhināyaka jaya hē
Bhārata-bhāgya-vidhātā,

Panjāba-Sindhu-Gujarāta-Marāthā
Drāvida-Utkala-Banga

Vindhya-Himāchala-Yamunā-Gangā
uchchala-jaladhi-taranga

Tava subha nāmē jāgē, tava subha āsisa māgē,
gāhē tava jaya-gāthā,

Jana-gana-mangala-dāyaka jaya hē
Bhārata-bhāgya-vidhātā,

Jaya hē, Jaya hē, Jaya hē,
Jaya jaya jaya, jaya hē.

PLEDGE

India is my country. All Indians
are my brothers and sisters.

I love my country, and I am proud
of its rich and varied heritage. I shall
always strive to be worthy of it.

I shall give my parents, teachers
and all elders respect, and treat
everyone with courtesy.

To my country and my people,
I pledge my devotion. In their
well-being and prosperity alone lies
my happiness.

Preface

Dear Students,

Welcome in the Eighth standard!

You have studied the text books from standard I to standard VII by now. We are glad to hand over the text book of standard VIII to you.

Some activities and constructions are given in the book. These will help you understand the subject and make it interesting. So carry them out earnestly. Discuss them with your friends. This will reveal some new properties in Mathematics.

It is expected that you read each chapter in the text book scrupulously. If a part is not understood, discuss it with teachers, parents or other students and get it cleared. You can also take help of information technology. Use the Q.R.codes given at the end of chapters.

When you understand the content of a unit in a lesson, solve the problems given in the practice sets. It will help you to better understand and remember the points in the unit. You yourself can construct problems similar to those given in the practice sets. The star marked problems in practice sets are a little challenging. Do solve these also.

In mathematics, sometimes the given information seems small but using mathematical argument we can derive more results from it. Tests of congruence of triangles is such an example. You are going to use these tests in your further studies extensively. So study the tests minutely.

In practical life we come across the terms such as compound interest, discount, commission etc. related to monetary transactions. These topics, as well as the topics of variation, areas of regular and irregular shapes, volumes of some three dimensional shapes etc. are explained in the text book.

Study of Mathematics frequently needs the knowledge acquired in previous standards. So important formulae, properties etc. in different units are given under the head 'Now I know'. Commit those to memory.

The eighth standard is the end of primary education. So study sincerely and enter the ninth standard with confidence to start secondary education.

All the best for it !



(Dr. Sunil Magar)

Director

Date : 18 April 2018, Akshayya Tritiya
Indian solar year : 28 Chaitra 1940

Maharashtra State Bureau of Textbook
Production and Curriculum Research, Pune.

English Mathematics - Standard VIII

Suggested Pedagogical Processes	Learning Outcomes
<p>The learner may be provided opportunities in pairs/groups/ individually and encouraged to —</p> <ul style="list-style-type: none"> • explore examples of rational numbers with all the operations and explore patterns in these operations. • explore patterns in square numbers, square roots, cubes and cube roots of numbers and form rules for exponents as integer. • provide situations that lead to simple equations and encourage them to solve using suitable processes. • multiply/experience two algebraic expressions and different polynomials may be provided based on their previous knowledge of distributive property of numbers and generalise various algebraic identities using concrete examples. • factorise algebraic expressions using relevant activities based on previous knowledge of factorising two numbers. • situation may be provided that involve the use of percentages in contexts like discount, profit and loss, simple and compound interest, etc. • provide various situations to generalise the formula of compound interests through repeated use of simple interest. • a number of situations may be given where one quantity depends on the other, the quantities increase together, or in which while one increases the other decreases. For example, as the speed of a vehicle increases the time taken by it to cover the distance decreases. • measure the angles and sides of different quadrilaterals and let them identify patterns in the relationship among them, let them make hypothesis on the basis of generalisation of the patterns and later on verify through examples. • verify the properties of parallelograms and apply reasoning by doing activities such as constructing parallelograms, drawing their diagonals and measuring their sides and angles. 	<p>The learner —</p> <p>08.71.01 generalises properties of addition, subtraction, multiplication and division of rational numbers through patterns.</p> <p>08.71.02 finds out as many rational numbers as possible between two given rational numbers.</p> <p>08.71.03 finds squares, cubes and square roots and cube roots of numbers using different methods.</p> <p>08.71.04 solves problems with integral exponents.</p> <p>08.71.05 solves puzzles and daily life problems using variables.</p> <p>08.71.06 multiplies algebraic expressions. For example, expands $(2x-5)(3x^2+7)$.</p> <p>08.71.07 uses various algebraic identities in solving problems of daily life.</p> <p>08.71.08 applies the concept of percent in profit and loss situation in finding discount and compound interest.</p> <p>08.71.09 calculates discount percent when marked price and actual discount are given or finds profit per cent when cost price and profit in a transaction are given.</p> <p>08.71.10 solves problems based on direct and inverse proportions.</p> <p>08.71.11 solves problems related to angles of a quadrilateral using angle sum property.</p> <p>08.71.12 verifies properties of parallelograms and establishes the relationship between them through reasoning.</p> <p>08.71.13 constructs different quadrilaterals using compasses and straight edge.</p> <p>08.71.14 verifies Euler's relation through pattern.</p>

<ul style="list-style-type: none"> • demonstrate the construction of various quadrilaterals using geometric kit. • sketch the figure of trapezium and other polygons in the given graph paper and ask students to estimate their areas using counting of unit square. • derive the formula for calculating area of trapezium using the areas of triangle and rectangle. (square) • identify that surfaces of various 3-D objects like cubes, cuboids and cylinder. • derive formulae for surface area of cubes and cuboids using the formulae for areas of rectangles, squares and circles. • demonstrate to find volume of a given cube and cuboid using unit cubes. • collect data, organise it into groups and represent it into bar graphs/ pie chart. • establish congruence criterion and later on verify the property by superimposing one above the other. • find a representative value of data, for example, mean, mode or median of ungrouped data. Encourage them to arrange it in a tabular form and represent it by bar graphs. 	<p>08.71.15 estimates the area of shapes like trapezium and other polygons by using square grid/graph sheet and verifies using formulas.</p> <p>08.71.16 finds the area of a polygon.</p> <p>08.71.17 finds surface area and volume of cuboidal and cylindrical object.</p> <p>08.71.18 draws and interprets bar charts.</p> <p>08.71.19 verifies the properties of angles formed by the transversal of two parallel lines.</p> <p>08.71.20 Uses, SSS, SAS, ASA, Hypo-side tests of congruence of triangles.</p> <p>08.71.21 estimates the area of closed figures using graph paper or grid paper.</p> <p>08.71.22 computes mean of the data used in day-to-day life.</p> <p>08.71.23 constructs parallel line to the given line.</p>
--	---

Guidelines for Teachers

It is expected that the text book of standard VIII should be used to establish dialogue with students. Tools such as question-answers, discussions, activities, etc. should be used to serve the purpose. This will be possible by reading the book thoroughly. While reading, underline the important sentences. Read the books of previous and next standards and other books also for reference. The matter on Q. R. code will also be useful.

In the book attempt is made to correlate mathematics with other subjects such as Environment, Geography, Science, Economics etc. Bring the fact to the notice of students. Encourage students to work out projects, activities and practicals. This will help students to understand the use of mathematics in practical life. In the text book, mathematical concepts are explained in simple language. It is expected that teachers should construct examples similar to those in practice sets and ask the students to solve them. Encourage the students also to construct and solve examples of their own.

The star-marked questions are a little challenging. The matter given under the head 'For more information' will definitely be useful to students for further studies.

We hope, you will definitely appreciate the book.

Index

Part 1

1.	Rational and Irrational numbers.....	01 to 06
2.	Parallel lines and transversals	07 to 13
3.	Indices and Cube root	14 to 18
4.	Altitudes and Medians of a triangle	19 to 22
5.	Expansion formulae	23 to 28
6.	Factorisation of Algebraic expressions	29 to 34
7.	Variation	35 to 40
8.	Quadrilateral : Constructions and Types	41 to 50
9.	Discount and Commission	51 to 58
	Miscellaneous Exercise 1	59 to 60

Part 2

10.	Division of Polynomials.....	61 to 66
11.	Statistics	67 to 74
12.	Equations in one variable.....	75 to 80
13.	Congruence of triangles	81 to 87
14.	Compound interest.....	88 to 93
15.	Area.....	94 to 105
16.	Surface area and Volume.....	106 to 113
17.	Circle : Chord and Arc	114 to 118
	Miscellaneous Exercise 2.....	119 to 120

1 Rational and Irrational numbers



Let's recall.

We are familiar with Natural numbers, Whole numbers, Integers and Rational numbers.

Natural numbers

1, 2, 3, 4, ...

Whole numbers

0, 1, 2, 3, 4, ...

Integers

..., -4, -3, -2, -1, 0, 1, 2, 3, ...

Rational numbers

$\frac{-25}{3}$, $\frac{10}{-7}$, -4, 0, 3, 8, $\frac{32}{3}$, $\frac{67}{5}$, etc.

Rational numbers : The numbers of the form $\frac{m}{n}$ are called rational numbers. Here, m and n are integers but n is not zero.

We have also seen that there are infinite rational numbers between any two rational numbers.



Let's learn.

To show rational numbers on a number line

Let us see how to show $\frac{7}{3}$, 2, $\frac{-2}{3}$ on a number line.

Let us draw a number line.

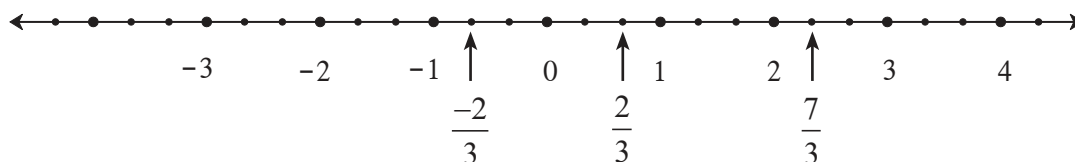

- We can show the number 2 on a number line.
- $\frac{7}{3} = 7 \times \frac{1}{3}$, therefore each unit on the right side of zero is to be divided in three equal parts. The seventh point from zero shows $\frac{7}{3}$; or $\frac{7}{3} = 2 + \frac{1}{3}$, hence the point at $\frac{1}{3}$ rd distance of unit after 2 shows $\frac{7}{3}$.

- To show $\frac{-2}{3}$ on the number line, first we show $\frac{2}{3}$ on it. The number to the left of 0 at the same distance will show the number $\frac{-2}{3}$.

Practice set 1.1

1. Show the following numbers on a number line. Draw a separate number line for each example.

(1) $\frac{3}{2}, \frac{5}{2}, -\frac{3}{2}$ (2) $\frac{7}{5}, \frac{-2}{5}, \frac{-4}{5}$ (3) $\frac{-5}{8}, \frac{11}{8}$ (4) $\frac{13}{10}, \frac{-17}{10}$

2. Observe the number line and answer the questions.

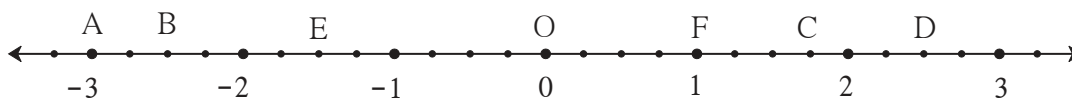

- Which number is indicated by point B?
- Which point indicates the number $1\frac{3}{4}$?
- State whether the statement, 'the point D denotes the number $\frac{5}{2}$ ', is true or false.



Let's learn.

Comparison of rational numbers

We know that, for any pair of numbers on a number line the number to the left is smaller than the other. Also, if the numerator and the denominator of a rational number is multiplied by any non zero number then the value of rational number does not change. It remains the same. That is, $\frac{a}{b} = \frac{ka}{kb}$, ($k \neq 0$).

Ex. (1) Compare the numbers $\frac{5}{4}$ and $\frac{2}{3}$. Write using the proper symbol of $<$, $=$, $>$.

Solution : $\frac{5}{4} = \frac{5 \times 3}{4 \times 3} = \frac{15}{12}$ $\frac{2}{3} = \frac{2 \times 4}{3 \times 4} = \frac{8}{12}$

$\frac{15}{12} > \frac{8}{12}$ $\therefore \frac{5}{4} > \frac{2}{3}$

Ex. (2) Compare the rational numbers $\frac{-7}{9}$ and $\frac{4}{5}$.

Solution : A negative number is always less than a positive number.

$$\text{Therefore, } -\frac{7}{9} < \frac{4}{5}.$$

To compare two negative numbers,

let us verify that if a and b are positive numbers such that $a < b$, then $-a > -b$.

$$\left. \begin{array}{l} 2 < 3 \text{ but } -2 > -3 \\ \frac{5}{4} < \frac{7}{4} \text{ but } \frac{-5}{4} > \frac{-7}{4} \end{array} \right\} \text{Verify the comparisons using a number line.}$$

Ex. (3) Compare the numbers $\frac{-7}{3}$ and $\frac{-5}{2}$.

Solution : Let us first compare $\frac{7}{3}$ and $\frac{5}{2}$.

$$\frac{7}{3} = \frac{7 \times 2}{3 \times 2} = \frac{14}{6}, \quad \frac{5}{2} = \frac{5 \times 3}{2 \times 3} = \frac{15}{6} \quad \text{and} \quad \frac{14}{6} < \frac{15}{6}$$
$$\therefore \frac{7}{3} < \frac{5}{2} \quad \therefore \frac{-7}{3} > \frac{-5}{2}$$

Ex. (4) $\frac{3}{5}$ and $\frac{6}{10}$ are rational numbers. Compare them.

Solution : $\frac{3}{5} = \frac{3 \times 2}{5 \times 2} = \frac{6}{10} \quad \therefore \frac{3}{5} = \frac{6}{10}$

The following rules are useful to compare two rational numbers.

If $\frac{a}{b}$ and $\frac{c}{d}$ are rational numbers such that b and d are positive, and

(1) if $a \times d < b \times c$ then $\frac{a}{b} < \frac{c}{d}$

(2) if $a \times d = b \times c$ then $\frac{a}{b} = \frac{c}{d}$

(3) if $a \times d > b \times c$ then $\frac{a}{b} > \frac{c}{d}$

Practice Set 1.2

1. Compare the following numbers.

- (1) $-7, -2$ (2) $0, \frac{-9}{5}$ (3) $\frac{8}{7}, 0$ (4) $\frac{-5}{4}, \frac{1}{4}$ (5) $\frac{40}{29}, \frac{141}{29}$
(6) $-\frac{17}{20}, \frac{-13}{20}$ (7) $\frac{15}{12}, \frac{7}{16}$ (8) $\frac{-25}{8}, \frac{-9}{4}$ (9) $\frac{12}{15}, \frac{3}{5}$ (10) $\frac{-7}{11}, \frac{-3}{4}$



Let's learn.

Decimal representation of rational numbers

If we use decimal fractions while dividing the numerator of a rational number by its denominator, we get the decimal representation of a rational number. For example, $\frac{7}{4} = 1.75$. In this case, after dividing 7 by 4, the remainder is zero. Hence the process of division ends.

Such a decimal form of a rational number is called a terminating decimal form.

We know that every rational number can be written in a non-terminating recurring decimal form.

For example, (1) $\frac{7}{6} = 1.1666\dots = 1.1\dot{6}$ (2) $\frac{5}{6} = 0.8333\dots = 0.8\dot{3}$

(3) $\frac{-5}{3} = -1.666\dots = -1.\dot{6}$

(4) $\frac{22}{7} = 3.142857142857\dots = 3.\overline{142857}$ (5) $\frac{23}{99} = 0.2323\dots = 0.\overline{23}$

Similarly, a terminating decimal form can be written as a non-terminating recurring decimal form. For example, $\frac{7}{4} = 1.75 = 1.75000\dots = 1.75\dot{0}$.

Practice Set 1.3

1. Write the following rational numbers in decimal form.

(1) $\frac{9}{37}$

(2) $\frac{18}{42}$

(3) $\frac{9}{14}$

(4) $\frac{-103}{5}$

(5) $-\frac{11}{13}$



Let's learn.

Irrational numbers

In addition to rational numbers, there are many more numbers on a number line. They are not rational numbers, that is, they are irrational numbers. $\sqrt{2}$ is such an irrational number.

We learn how to show the number $\sqrt{2}$ on a number line.

- On a number line, the point A shows the number 1. Draw line l perpendicular to the number line through point A.

Take point P on line l such that $OA = AP = 1$ unit.

- Draw seg OP. The Δ OAP formed is a right angled triangle.

By Pythagoras theorem,

$$OP^2 = OA^2 + AP^2$$

$$= 1^2 + 1^2 = 1 + 1 = 2$$

$$OP^2 = 2$$

$$\therefore OP = \sqrt{2} \text{ ... (taking square roots on both sides)}$$

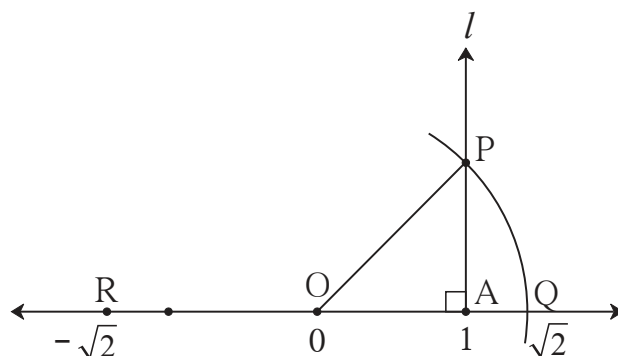

- Now, draw an arc with centre O and radius OP. Name the point as Q where the arc intersects the number line. Obviously distance OQ is $\sqrt{2}$. That is, the number shown by the point Q is $\sqrt{2}$.

If we mark point R on the number line to the left of O, at the same distance as OQ, then it will indicate the number $-\sqrt{2}$.

We will prove that $\sqrt{2}$ is an irrational number in the next standard. We will also see that the decimal form of an irrational number is non-terminating and non-recurring.

Note that -

In the previous standard we have learnt that π is not a rational number. It means it is irrational. For calculation purpose we take its value as $\frac{22}{7}$ or 3.14 which are very close to π ; but $\frac{22}{7}$ and 3.14 are rational numbers.

The numbers which can be shown by points of a number line are called real numbers. We have seen that all rational numbers can be shown by points of a number line. Therefore, all rational numbers are real numbers. There are infinitely many irrational numbers on the number line.

$\sqrt{2}$ is an irrational number. Note that the numbers like $3\sqrt{2}$, $7 + \sqrt{2}$, $3 - \sqrt{2}$ etc. are also irrational numbers; because if $3\sqrt{2}$ is rational then $\frac{3\sqrt{2}}{3}$ should also be a rational number, which is not true.

We learnt to show rational numbers on a number line. We have shown the irrational number $\sqrt{2}$ on a number line. Similarly we can show irrational numbers like $\sqrt{3}$, $\sqrt{5}$. . . on a number line.

Practice Set 1.4

1. The number $\sqrt{2}$ is shown on a number line. Steps are given to show $\sqrt{3}$ on the number line using $\sqrt{2}$. Fill in the boxes properly and complete the activity.

Activity :

- The point Q on the number line shows the number
- A line perpendicular to the number line is drawn through the point Q. Point R is at unit distance from Q on the line.
- Right angled Δ ORQ is obtained by drawing seg OR.
- $l(OQ) = \sqrt{2}$, $l(QR) = 1$

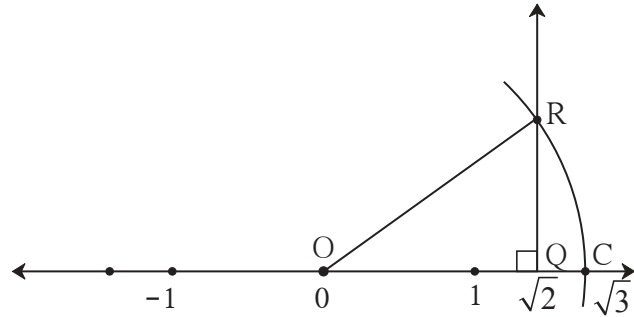

\therefore by Pythagoras theorem,

$$\begin{aligned}
 [l(OR)]^2 &= [l(OQ)]^2 + [l(QR)]^2 \\
 &= \boxed{}^2 + \boxed{}^2 = \boxed{} + \boxed{} \\
 &= \boxed{} \quad \therefore l(OR) = \boxed{}
 \end{aligned}$$

Draw an arc with centre O and radius OR. Mark the point of intersection of the line and the arc as C. The point C shows the number $\sqrt{3}$.

2. Show the number $\sqrt{5}$ on the number line.
- 3* Show the number $\sqrt{7}$ on the number line.



Answers

Practice Set 1.1

2. (1) $\frac{-10}{4}$ (2) C (3) True

Practice Set 1.2

1. (1) $-7 < -2$ (2) $0 > \frac{-9}{5}$ (3) $\frac{8}{7} > 0$ (4) $\frac{-5}{4} < \frac{1}{4}$ (5) $\frac{40}{29} < \frac{141}{29}$
- (6) $\frac{-17}{20} < \frac{-13}{20}$ (7) $\frac{15}{12} > \frac{7}{16}$ (8) $\frac{-25}{8} < \frac{-9}{4}$ (9) $\frac{12}{15} > \frac{3}{5}$
- (10) $\frac{-7}{11} > \frac{-3}{4}$

Practice Set 1.3

- (1) $0.\overline{243}$ (2) $0.\overline{428571}$ (3) $0.\overline{6428571}$ (4) $-20.\overline{6}$ (5) $-0.\overline{846153}$

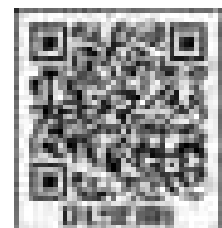

2

Parallel lines and transversal



Let's recall.

The lines in the same plane which do not intersect each other are called parallel lines.

'Line l and line m are parallel lines,' is written as

'line $l \parallel$ line m '.

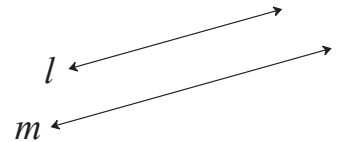

Let's learn.

Transversal

In the adjoining figure, line l intersects line m and line n in two distinct points. line l is a transversal of line m and line n .

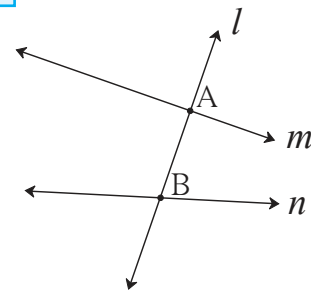

If a line intersects given two lines in two distinct points then that line is called a transversal of those two lines.

Angles made by a transversal

In the adjoining figure, due to the transversal, there are two distinct points of intersection namely M and N. At each of these points, four angles are formed. Hence there are 8 angles in all. Each of these angles has one arm on the transversal and the other is on one of the given lines. These angles are grouped in different pairs of angles. Let's study the pairs.

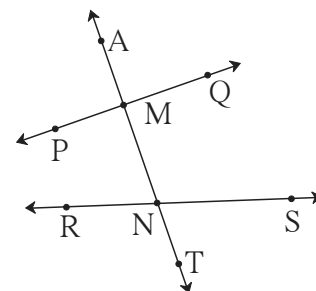

• Corresponding angles

If the arms on the transversal of a pair of angles are in the same direction and the other arms are on the same side of the transversal, then it is called a pair of corresponding angles.

• Interior angles

A pair of angles which are on the same side of the transversal and inside the given lines is called a pair of interior angles.

pairs of corresponding angles in the given figure -

- (i) $\angle AMP$ and $\angle MNR$
- (ii) $\angle PMN$ and $\angle RNT$
- (iii) $\angle AMQ$ and $\angle MNS$
- (iv) $\angle QMN$ and $\angle SNT$

pairs of interior angles in the given figure -

- (i) $\angle PMN$ and $\angle MNR$
- (ii) $\angle QMN$ and $\angle MNS$

Alternate angles

Pairs of angles which are on the opposite sides of transversal and their arms on the transversal show opposite directions is called a pair of alternate angles.

In the figure, there are two pairs of interior alternate angles and two pairs of exterior alternate angles.

Interior alternate angles

(Angles at the inner side of lines)

- (i) $\angle PMN$ and $\angle MNS$
- (ii) $\angle QMN$ and $\angle RNM$

Exterior alternate angles

(Angles at the outer side of lines)

- (i) $\angle AMP$ and $\angle TNS$
- (ii) $\angle AMQ$ and $\angle RNT$

Practice Set 2.1

1. In the adjoining figure, each angle is shown by a letter. Fill in the boxes with the help of the figure.

Corresponding angles.

- (1) $\angle p$ and
- (2) $\angle q$ and
- (3) $\angle r$ and
- (4) $\angle s$ and

Interior alternate angles.

- (5) $\angle s$ and
- (6) $\angle w$ and

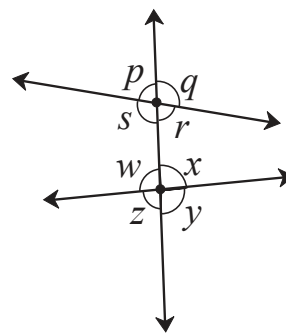

2. Observe the angles shown in the figure and write the following pair of angles.

- (1) Interior alternate angles
- (2) Corresponding angles
- (3) Interior angles

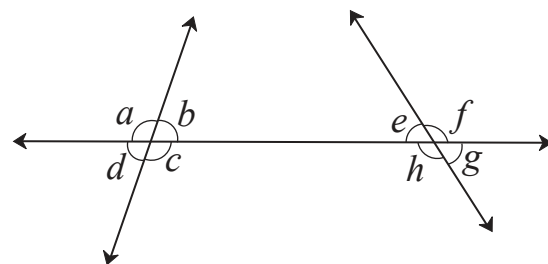

**Properties of angles formed by two parallel lines and a transversal**

Activity (I) : As shown in the figure (A), draw two parallel lines and their transversal on a paper. Draw a copy of the figure on another blank sheet using a trace paper, as shown in the figure (B). Colour part I and part II with different colours. Cut out the two parts with a pair of scissors.

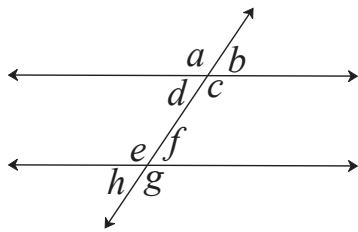

(A)

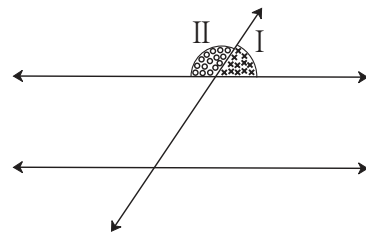

(B)

Note that the angles shown by part I and part II form a linear pair. Place, part I and part II on each angle in the figure A.

Which angles coincide with part I ?

Which angles coincide with part II ?

We see that, $\angle b \cong \angle d \cong \angle f \cong \angle h$, because these angles coincide with part I.

$\angle a \cong \angle c \cong \angle e \cong \angle g$, because these angles coincide with part II.

$$(1) \angle a \cong \angle e, \angle b \cong \angle f, \angle c \cong \angle g, \angle d \cong \angle h$$

(These are pairs of corresponding angles.)

$$(2) \angle d \cong \angle f \text{ and } \angle e \cong \angle c \text{ (These are pairs of interior alternate angles.)}$$

$$(3) \angle a \cong \angle g \text{ and } \angle b \cong \angle h \text{ (These are pairs of exterior alternate angles.)}$$

$$(4) m\angle d + m\angle e = 180^\circ \text{ and } m\angle c + m\angle f = 180^\circ$$

(These are interior angles.)



When two parallel lines are intersected by a transversal eight angles are formed. If the measure of one of these eight angles is given, can we find measures of remaining seven angles ?



Let's learn.

(1) Property of corresponding angles

Each pair of corresponding angles formed by two parallel lines and their transversal is of congruent angles.

In the adjoining figure line $PQ \parallel$ line RS .
Line AB is a transversal.

Corresponding angles

$$\begin{aligned} \angle AMP &\cong \angle MNR & \angle PMN &\cong \angle RNB \\ \angle AMQ &\cong \angle MNS & \angle QMN &\cong \angle SNB \end{aligned}$$

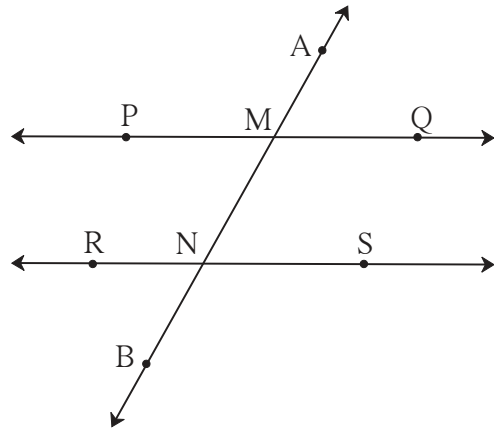

(2) Property of alternate angles

Each pair of alternate angles formed by two parallel lines and their transversal is of congruent angles.

Interior alternate angles Exterior alternate angles

$$\begin{aligned} \angle PMN &\cong \angle MNS & \angle AMP &\cong \angle SNB \\ \angle QMN &\cong \angle MNR & \angle AMQ &\cong \angle RNB \end{aligned}$$

(3) Property of interior angles

Each pair of interior angles formed by two parallel lines and their transversal is of supplementary angles.

Interior angles

$$\begin{aligned} m\angle PMN + m\angle MNR &= 180^\circ \\ m\angle QMN + m\angle MNS &= 180^\circ \end{aligned}$$

Solved Examples

Ex. (1) In the adjoining figure line $AB \parallel$ line PQ .

Line LM is a transversal.

$m\angle MNQ = 70^\circ$, then find $m\angle AON$.

Solution : **Method I**

$$\begin{aligned} m\angle MNQ &= m\angle ONP = 70^\circ \dots (\text{Opposite angles}) \\ m\angle AON + m\angle ONP &= 180^\circ \dots (\text{Interior angles}) \\ \therefore m\angle AON &= 180^\circ - m\angle ONP \\ &= 180^\circ - 70^\circ \\ &= 110^\circ \end{aligned}$$

(The above example can be solved by another method also.)

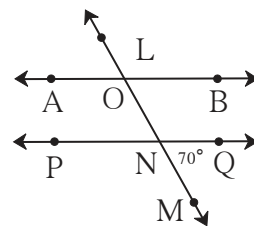

Method II

$$\begin{aligned} m\angle MNQ &= 70^\circ \\ \therefore m\angle NOB &= 70^\circ \dots (\text{Corresponding angles}) \\ m\angle AON + m\angle NOB &= 180^\circ \\ \therefore m\angle AON + 70^\circ &= 180^\circ \\ \therefore m\angle AON &= 110^\circ \end{aligned}$$

Ex. (2) In the adjoining figure line $m \parallel$ line n
line l is a transversal.
If $m\angle b = (x + 15)^\circ$ and
 $m\angle e = (2x + 15)^\circ$, find the value of x .

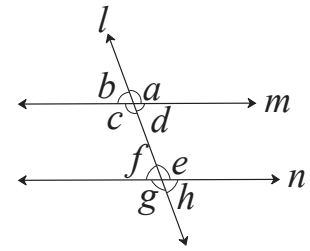

Solution : $\angle b \cong \angle f$ (corresponding angles) $\therefore m\angle f = m\angle b = (x + 15)^\circ$
 $m\angle f + m\angle e = 180^\circ$ (Angles in linear pair)
substituting values in the equation,
 $x + 15 + 2x + 15 = 180^\circ$ $\therefore 3x + 30 = 180^\circ$
 $\therefore 3x = 180^\circ - 30^\circ = 150^\circ$ (subtracting 30 from both sides)
 $x = \frac{150^\circ}{3}$ (dividing both sides by 3)
 $\therefore x = 50^\circ$



Now I know.

When two parallel lines are intersected by a transversal, the angles formed in each pair of

- corresponding angles are congruent.
- alternate angles are congruent.
- interior angles are supplementary.

Practice Set 2.2

1. Choose the correct alternative.

(1) In the adjoining figure, if line $m \parallel$ line n
and line p is a transversal then find x .

- (A) 135° (B) 90° (C) 45° (D) 40°

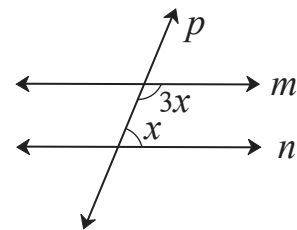

(2) In the adjoining figure, if line $a \parallel$ line b
and line l is a transversal then find x .

- (A) 90° (B) 60° (C) 45° (D) 30°

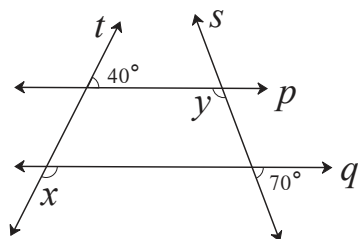
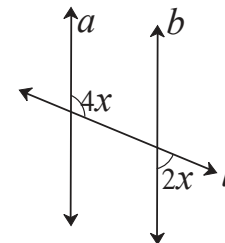

2. In the adjoining figure line $p \parallel$ line q .
Line t and line s are transversals.
Find measure of $\angle x$ and $\angle y$
using the measures of angles given
in the figure.

3. In the adjoining figure. line $p \parallel$ line q . line $l \parallel$ line m . Find measures of $\angle a$, $\angle b$, and $\angle c$, using the measures of given angles. Justify your answers.

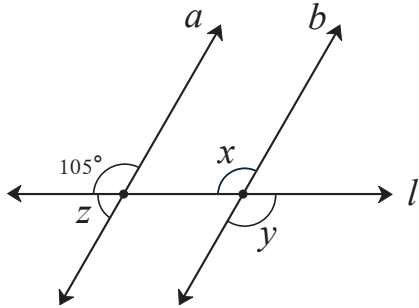
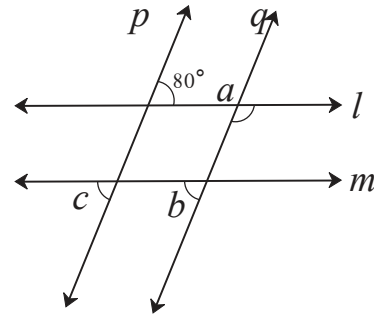

- 5*. In the adjoining figure, line $p \parallel$ line $l \parallel$ line q . Find $\angle x$ with the help of the measures given in the figure.

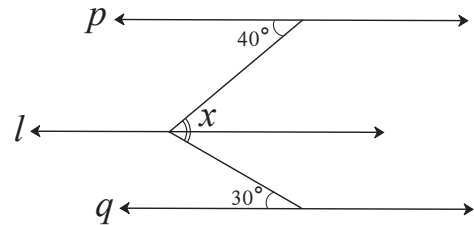

For more information :

- If a transversal intersects two coplaner lines and a pair of corresponding angles is congruent then the lines are parallel.
- alternate angles is congruent then the lines are parallel.
- interior angles is supplementary then the lines are parallel.

To draw a line parallel to the given line

Construction (I) : To draw a line parallel to the given line through a point outside the given line using set - square.

Method I : Steps of the construction

- (1) Draw line l .
- (2) Take a point P outside the line l .
- (3) As shown in the figure, place two set - squares touching each other. Hold set - squares A and B . One edge of set - square A is close to point P . Draw a line along the edge of B .
- (4) Name the line as m .
- (5) Line m is parallel to line l .

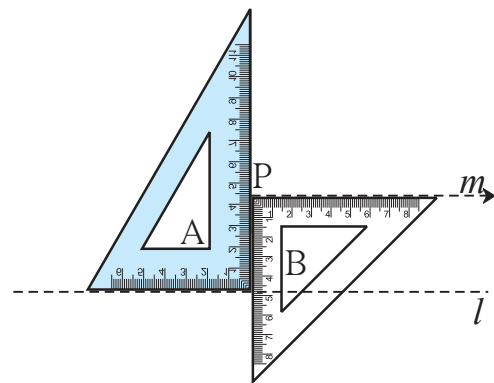

Method II : Steps of construction

- (1) Draw line l . Take a point P outside the line.
- (2) Draw a seg $PM \perp$ line l .
- (3) Take another point N on line l .
- (4) Draw seg $NQ \perp$ line l such that $l(NQ) = l(MP)$.
- (5) The line m passing through points P and Q is parallel to the line l .

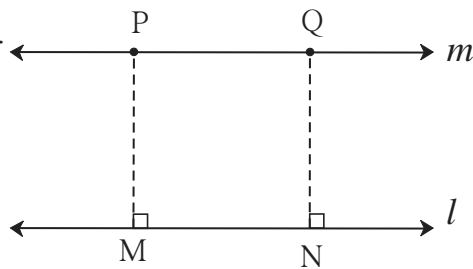

Construction (II) : To draw a parallel line to a given line at a given distance.

Method : Draw a line parallel to line l at a distance 2.5 cm.

Steps of construction :

- (1) Draw line l .
- (2) Take two points A and B on the line l .
- (3) Draw perpendiculars to the line l from points A and B.
- (4) On the perpendicular lines take points P and Q at a distance of 2.5cm from A and B respectively.
- (5) Draw line PQ. (6) Line PQ is a line parallel to the line l at a distance 2.5cm.

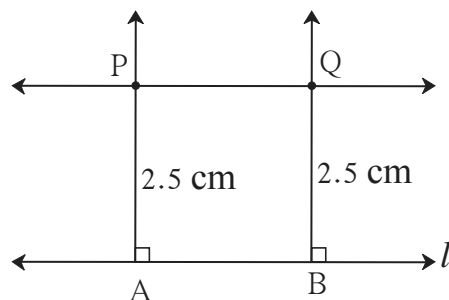

Practice Set 2.3

1. Draw a line l . Take a point A outside the line. Through point A draw a line parallel to line l .
2. Draw a line l . Take a point T outside the line. Through point T draw a line parallel to line l .
3. Draw a line m . Draw a line n which is parallel to line m at a distance of 4 cm from it.



Answers

Practice Set 2.1 1. (1) $\angle w$ (2) $\angle x$ (3) $\angle y$ (4) $\angle z$ (5) $\angle x$ (6) $\angle r$

2. (1) $\angle c$ and $\angle e$, $\angle b$ and $\angle h$ (2) $\angle a$ and $\angle e$, $\angle b$ and $\angle f$, $\angle c$ and $\angle g$, $\angle d$ and $\angle h$ (3) $\angle c$ and $\angle h$, $\angle b$ and $\angle e$.

Practice Set 2.2 1. (1) C (2) D 2. $\angle x = 140^\circ$, $\angle y = 110^\circ$

3. $\angle a = 100^\circ$, $\angle b = 80^\circ$, $\angle c = 80^\circ$ 4. $\angle x = 105^\circ$, $\angle y = 105^\circ$, $\angle z = 75^\circ$

5. $\angle x = 70^\circ$

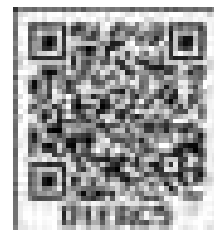

3

Indices and Cube root

Let's recall.

In earlier standards, we have learnt about Indices and laws of indices.

- The product $2 \times 2 \times 2 \times 2 \times 2$, can be expressed as 2^5 , in which 2 is the base, 5 is the index and 2^5 is the index form of the number.

- Laws of indices : If m and n are integers, then

$$(i) a^m \times a^n = a^{m+n} \quad (ii) a^m \div a^n = a^{m-n} \quad (iii) (a \times b)^m = a^m \times b^m \quad (iv) a^0 = 1$$

$$(v) a^{-m} = \frac{1}{a^m} \quad (vi) (a^m)^n = a^{mn} \quad (vii) \left(\frac{a}{b}\right)^m = \frac{a^m}{b^m} \quad (viii) \left(\frac{a}{b}\right)^{-m} = \left(\frac{b}{a}\right)^m$$

- Using laws of indices, write proper numbers in the following boxes.

$$(i) 3^5 \times 3^2 = 3^{\square} \quad (ii) 3^7 \div 3^9 = 3^{\square} \quad (iii) (3^4)^5 = 3^{\square}$$

$$(iv) 5^{-3} = \frac{1}{5^{\square}} \quad (v) 5^0 = \square \quad (vi) 5^1 = \square$$

$$(vii) (5 \times 7)^2 = 5^{\square} \times 7^{\square} \quad (viii) \left(\frac{5}{7}\right)^3 = \frac{\square^3}{\square^3} \quad (ix) \left(\frac{5}{7}\right)^{-3} = \left(\frac{\square}{\square}\right)^3$$

Let's learn.

Meaning of numbers with rational indices

(I) Meaning of the numbers when the index is a rational number of the form $\frac{1}{n}$.

Let us see the meaning of indices in the form of rational numbers such as

$$\frac{1}{2}, \frac{1}{3}, \frac{1}{5}, \dots, \frac{1}{n}.$$

To show the square of a number, the index is written as 2 and to show the square root of a number, the index is written as $\frac{1}{2}$.

For example, square root of 25, is written as $\sqrt{25}$ using the radical sign ' $\sqrt{\quad}$ '.

Using index, it is expressed as $25^{\frac{1}{2}}$. $\therefore \sqrt{25} = 25^{\frac{1}{2}}$.

In general, square of a can be written as a^2 and square root of a is written as $\sqrt[2]{a}$ or \sqrt{a} or $a^{\frac{1}{2}}$.

Similarly, cube of a is written as a^3 and cube root of a is written as $\sqrt[3]{a}$ or $a^{\frac{1}{3}}$.

For example, $4^3 = 4 \times 4 \times 4 = 64$.

\therefore cube root of 64 can be written as $\sqrt[3]{64}$ or $(64)^{\frac{1}{3}}$. Note that, $64^{\frac{1}{3}} = 4$

$3 \times 3 \times 3 \times 3 \times 3 = 3^5 = 243$. That is 5th power of 3 is 243.

Conversely, 5th root of 243 is expressed as $(243)^{\frac{1}{5}}$ or $\sqrt[5]{243}$. Hence, $(243)^{\frac{1}{5}} = 3$

In genral n^{th} root of a is expressed as $a^{\frac{1}{n}}$.

For example, (i) $128^{\frac{1}{7}} = 7^{\text{th}}$ root of 128, (ii) $900^{\frac{1}{12}} = 12^{\text{th}}$ root of 900, etc.

Note that, If $10^{\frac{1}{5}} = x$ then $x^5 = 10$.

Practice Set 3.1

1. Express the following numbers in index form.

(1) Fifth root of 13 (2) Sixth root of 9 (3) Square root of 256

(4) Cube root of 17 (5) Eighth root of 100 (6) Seventh root of 30

2. Write in the form 'nth root of a' in each of the following numbers.

(1) $(81)^{\frac{1}{4}}$ (2) $49^{\frac{1}{2}}$ (3) $(15)^{\frac{1}{5}}$ (4) $(512)^{\frac{1}{9}}$ (5) $100^{\frac{1}{19}}$ (6) $(6)^{\frac{1}{7}}$

(II) The meaning of numbers, having index in the rational form $\frac{m}{n}$.

We know that $8^2 = 64$,

Cube root at 64 is $= (64)^{\frac{1}{3}} = (8^2)^{\frac{1}{3}} = 4$

\therefore cube root of square of 8 is 4 (I)

Similarly, cube root of 8 $= 8^{\frac{1}{3}} = 2$

\therefore square of cube root of 8 is $\left(8^{\frac{1}{3}}\right)^2 = 2^2 = 4$ (II)

From (I) and (II)

cube root of square of 8 = square of cube root of 8. Using indices, $(8^2)^{\frac{1}{3}} = \left(8^{\frac{1}{3}}\right)^2$.

The rules for rational indices are the same as those for integral indices

\therefore using the rule $(a^m)^n = a^{mn}$, we get $(8^2)^{\frac{1}{3}} = \left(8^{\frac{1}{3}}\right)^2 = 8^{\frac{2}{3}}$.

From this we get two meanings of the number $8^{\frac{2}{3}}$.

(i) $8^{\frac{2}{3}} = (8^2)^{\frac{1}{3}}$ i. e. cube root of square of 8.

(ii) $8^{\frac{2}{3}} = \left(8^{\frac{1}{3}}\right)^2$ i. e. square of cube root of 8.

Similarly, $27^{\frac{4}{5}} = (27^4)^{\frac{1}{5}}$ means ‘fifth root of fourth power of 27’,

and $27^{\frac{4}{5}} = \left(27^{\frac{1}{5}}\right)^4$ means ‘fourth power of fifth root of 27’.

Generally we can express two meanings of the number $a^{\frac{m}{n}}$.

$a^{\frac{m}{n}} = (a^m)^{\frac{1}{n}}$ means ‘ n^{th} root of m^{th} power of a ’.

$a^{\frac{m}{n}} = \left(a^{\frac{1}{n}}\right)^m$ means ‘ m^{th} power of n^{th} root of a ’.

Practice Set 3.2

1. Complete the following table.

Sr. No.	Number	Power of the root	Root of the power
(1)	$(225)^{\frac{3}{2}}$	Cube of square root of 225	Square root of cube of 225
(2)	$(45)^{\frac{4}{5}}$		
(3)	$(81)^{\frac{6}{7}}$		
(4)	$(100)^{\frac{4}{10}}$		
(5)	$(21)^{\frac{3}{7}}$		

2. Write the following numbers in the form of rational indices.

(1) Square root of 5th power of 121. (2) Cube of 4th root of 324

(3) 5th root of square of 264 (4) Cube of cube root of 3



Let's recall.

- $4 \times 4 = 16$ implies $4^2 = 16$, also $(-4)^2 = 16$ which indicates that the number 16 has two square roots ; one positive and the other negative. Conventionally, positive root of 16 is shown as $\sqrt{16}$ and negative root of 16 is shown as $-\sqrt{16}$. Hence $\sqrt{16} = 4$ and $-\sqrt{16} = -4$.
- Every positive number has two square roots.
- Square root of zero is zero.

**Cube and Cube Root**

If a number is written 3 times and multiplied, then the product is called the cube of the number. For example, $6 \times 6 \times 6 = 6^3 = 216$. Hence 216 is the cube of 6.

To find the cube of rational number.

Ex. (1) Find the cube of 17.

$$17^3 = 17 \times 17 \times 17 \\ = 4913$$

Ex. (2) Find the cube of (-6).

$$(-6)^3 = (-6) \times (-6) \times (-6) \\ = -216$$

Ex. (3) Find the cube of $\left(-\frac{2}{5}\right)$.

$$\left(-\frac{2}{5}\right)^3 = \left(-\frac{2}{5}\right) \times \left(-\frac{2}{5}\right) \times \left(-\frac{2}{5}\right) \\ = -\frac{8}{125}$$

Ex. (4) Find the cube of (1.2).

$$(1.2)^3 = 1.2 \times 1.2 \times 1.2 \\ = 1.728$$

Ex. (5) Find the cube of (0.02).

$$(0.02)^3 = 0.02 \times 0.02 \times 0.02 \\ = 0.000008$$



In Ex. (1) 17 is a positive number. The cube of 17, which is 4913, is also a positive number.

In Ex. (2) cube of -6 is -216. Take some more positive and negative numbers and obtain their cubes. Find the relation between the sign of a number and the sign of its cube.

In Ex. (4) and (5), observe the number of decimal places in the number and number of decimal places in the cube of the number. Is there any relation between the two ?

To find the cube root

We know, how to find the square root of a number by factorisation method. Using the same method, we can find the cube root.

Ex. (1) Find the cube root of 216.

Solution : First find the prime factor of 216. $216 = 2 \times 2 \times 2 \times 3 \times 3 \times 3$

Each of the factors 3 and 2, appears thrice. So let us group them as given below,

$$216 = (3 \times 2) \times (3 \times 2) \times (3 \times 2) = (3 \times 2)^3 = 6^3$$

$$\therefore \sqrt[3]{216} = 6 \quad \text{that is } (216)^{\frac{1}{3}} = 6$$

Ex. (2) Find the cube root of -1331 .

Solution : To find the cube root of -1331 , let us factorise 1331 first.

$$1331 = 11 \times 11 \times 11 = 11^3$$

$$\begin{aligned} -1331 &= (-11) \times (-11) \times (-11) \\ &= (-11)^3 \end{aligned}$$

$$\therefore \sqrt[3]{-1331} = -11$$

Ex. (4) Find $\sqrt[3]{0.125}$.

Solution : $\sqrt[3]{0.125} = \sqrt[3]{\frac{125}{1000}}$

$$= \frac{\sqrt[3]{125}}{\sqrt[3]{1000}} \dots \left(\frac{a}{b}\right)^m = \frac{a^m}{b^m}$$

$$= \frac{\sqrt[3]{5^3}}{\sqrt[3]{10^3}}$$

$$= \frac{5}{10} = 0.5 \dots (a^m)^{\frac{1}{m}} = a$$

Ex. (3) Find the cube root of 1728 .

Solution : $1728 = 8 \times 216 = 2 \times 2 \times 2 \times 6 \times 6 \times 6$

$$\therefore 1728 = 2^3 \times 6^3 = (2 \times 6)^3 \dots \dots \dots a^m \times b^m = (a \times b)^m$$

$$\sqrt[3]{1728} = 2 \times 6 = 12 \quad (\text{Note that, cube root of } -1728 \text{ is } -12.)$$

Practice Set 3.3

1. Find the cube roots of the following numbers.

- (1) 8000 (2) 729 (3) 343 (4) -512 (5) -2744 (6) 32768

2. Simplify : (1) $\sqrt[3]{\frac{27}{125}}$ (2) $\sqrt[3]{\frac{16}{54}}$ 3. If $\sqrt[3]{729} = 9$ then $\sqrt[3]{0.000729} = ?$



Answers

Practice Set 3.1 (1) $13^{\frac{1}{5}}$ (2) $9^{\frac{1}{6}}$ (3) $256^{\frac{1}{2}}$ (4) $17^{\frac{1}{3}}$ (5) $100^{\frac{1}{8}}$ (6) $30^{\frac{1}{7}}$

2. (1) Fourth root of 81. (2) Square root of 49 (3) Fifth root of 15
(4) Ninth root of 512 (5) Nineteenth root of 100 (6) Seventh root of 6

Practice Set 3.2 1. (2) 4th power of 5th root of 45 ; 5th root of 4th power of 45.
(3) 6th power of 7th root of 81 ; 7th root of 6th power of 81.
(4) 4th power of 10th root of 100 ; 10th root of 4th power of 100.
(5) 3rd power of 7th root of 21 ; 7th root of 3rd power of 21.

2. (1) $(121)^{\frac{5}{2}}$ (2) $(324)^{\frac{3}{4}}$ (3) $(264)^{\frac{2}{5}}$ (4) $3^{\frac{3}{3}}$

Practice Set 3.3 1. (1) 20 (2) 9 (3) 7 (4) -8 (5) -14

(6) 32 2. (1) $\frac{3}{5}$ (2) $\frac{2}{3}$ 3. 0.09



4

Altitudes and Medians of a triangle

Let's recall.

In the previous standard we have learnt that the bisectors of angles of a triangle, as well as the perpendicular bisectors of its sides are concurrent. These points of concurrence are respectively called the incentre and the circumcentre of the triangle.

Activity :

Draw a line. Take a point outside the line. Draw a perpendicular from the point to the line with the help of a set - square.

Let's learn.

Altitude

The perpendicular segment drawn from a vertex of a triangle on the side opposite to it is called an altitude of the triangle. In ΔABC , seg AP is an altitude on the base BC .

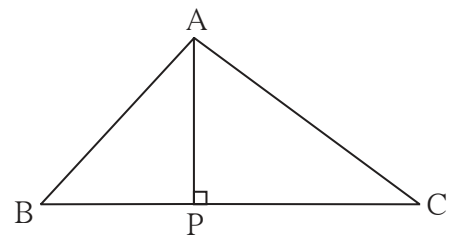

To draw altitudes of a triangle :

1. Draw any ΔXYZ .
2. Draw a perpendicular from vertex X on the side YZ using a set - square. Name the point where it meets side YZ as R . Seg XR is an altitude on side YZ .
3. Considering side XZ as a base, draw an altitude YQ on side XZ . seg $YQ \perp$ seg XZ .
4. Consider side XY as a base, draw an altitude ZP on seg XY . seg $ZP \perp$ seg XY .

seg XR , seg YQ , seg ZP are the altitudes of ΔXYZ .

Note that, the three altitudes are concurrent.

The point of concurrence is called the orthocentre of the triangle. It is denoted by the letter 'O'.

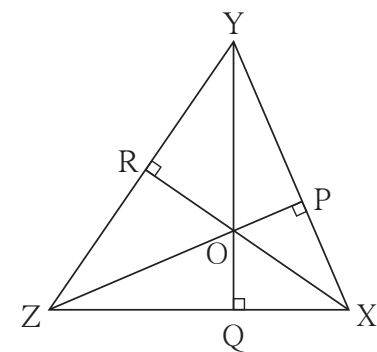
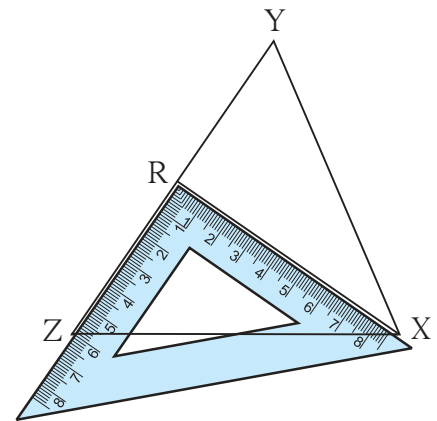

The location of the orthocentre of a triangle :

Activity I :

Draw a right angled triangle and draw all its altitudes. Write the point of concurrence.

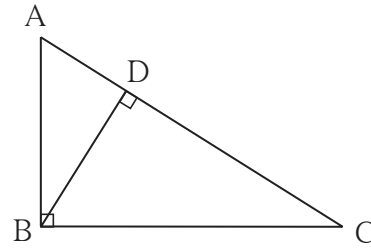

Activity II :

Draw an obtuse angled triangle and all its altitudes.

Do they intersect each other ?

Draw the lines containing the altitudes. Observe that these lines are concurrent.

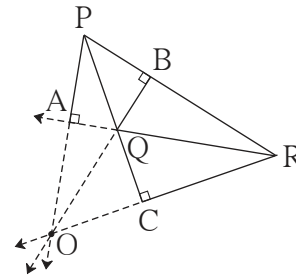

Activity III :

Draw an acute angled ΔABC and all its altitudes.

Observe the location of the orthocentre.

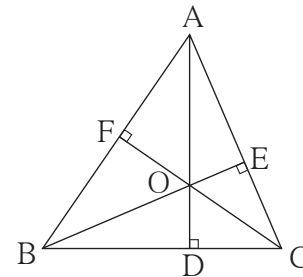

Now I know.

The altitudes of a triangle pass through exactly one point; that means they are concurrent. The point of concurrence is called the orthocentre and it is denoted by 'O'.

- The orthocentre of a right angled triangle is the vertex of the right angle.
- The orthocentre of an obtuse angled triangle is in the exterior of the triangle.
- The orthocentre of an acute angled triangle is in the interior of the triangle.



Let's learn.

Median

The segment joining the vertex and midpoint of the opposite side is called a median of the triangle.

In ΔHCF , seg FD is a median on the base CH .

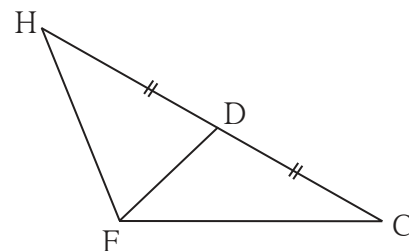

To draw medians of a triangle :

1. Draw ΔABC .
2. Find the mid-point P of side AB. Draw seg CP.
3. Find the mid-point Q of side BC. Draw seg AQ.
4. Find the mid-point R of side AC. Draw seg BR.

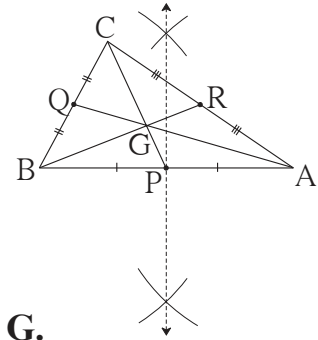

Seg PC, seg QA and seg BR are medians of ΔABC .

Note that the medians are concurrent. **Their point of concurrence is called the centroid. It is denoted by G.**

Activity IV : Draw three different triangles ; a right angled triangle, an obtuse angled triangle and an acute angled triangle. Draw the medians of the triangles. Note that the centroid of each of them is in the interior of the triangle.

The property of the centroid of a triangle :

- Draw a sufficiently large ΔABC .
- Draw medians ; seg AR, seg BQ and seg CP of ΔABC .
- Name the point of concurrence as G.

Measure the lengths of segments from the figure and fill in the boxes in the following table.

$l(AG) =$ <input type="text"/>	$l(GR) =$ <input type="text"/>	$l(AG) : l(GR) =$ <input type="text"/> :
$l(BG) =$ <input type="text"/>	$l(GQ) =$ <input type="text"/>	$l(BG) : l(GQ) =$ <input type="text"/> :
$l(CG) =$ <input type="text"/>	$l(GP) =$ <input type="text"/>	$l(CG) : l(GP) =$ <input type="text"/> :

Observe that all of these ratios are nearly 2:1.

 **Now I know.**

The medians of a triangle are concurrent. Their point of concurrence is called the Centroid and it is denoted by G. For all types of triangles the location of G is in the interior of the triangles. The centroid divides each median in the ratio 2:1.

 **Let's discuss.**

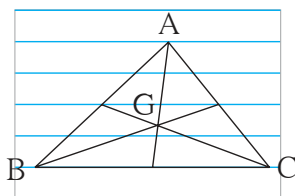

As shown in the adjacent figure, a student drew ΔABC using five parallel lines of a note book. Then he found the centroid G of the triangle. How will you decide whether the location of G he found, is correct.

Practice Set 4.1

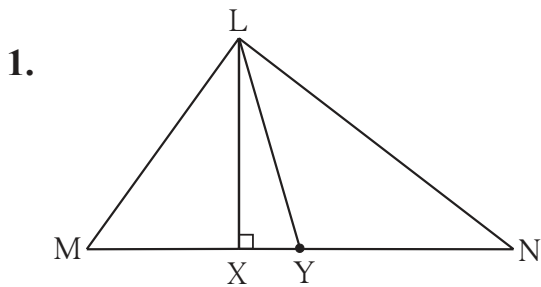

In ΔLMN , is an altitude and is a median. (write the names of appropriate segments.)

2. Draw an acute angled ΔPQR . Draw all of its altitudes. Name the point of concurrence as 'O'.
3. Draw an obtuse angled ΔSTV . Draw its medians and show the centroid.
4. Draw an obtuse angled ΔLMN . Draw its altitudes and denote the orthocentre by 'O'.
5. Draw a right angled ΔXYZ . Draw its medians and show their point of concurrence by G.
6. Draw an isosceles triangle. Draw all of its medians and altitudes. Write your observation about their points of concurrence.
7. Fill in the blanks.

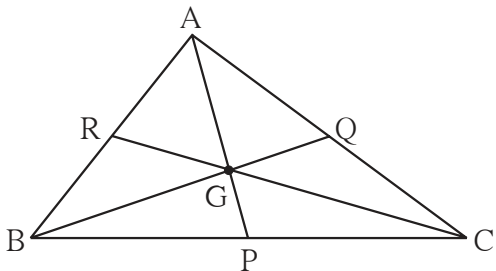

Point G is the centroid of ΔABC .

- (1) If $l(RG) = 2.5$ then $l(GC) = \dots\dots$
- (2) If $l(BG) = 6$ then $l(BQ) = \dots\dots$
- (3) If $l(AP) = 6$ then $l(AG) = \dots\dots$
and $l(GP) = \dots\dots$



Try this.

- (I)** : Draw an equilateral triangle. Find its circumcentre (C), incentre (I), centroid (G) and orthocentre (O). Write your observation.
- (II)**: Draw an isosceles triangle. Locate its centroid, orthocentre, circumcentre and incentre. Verify that they are collinear.



Answers

Practice Set 4.1

1. seg LX and seg LY 7. (1) 5, (2) 9, (3) 4, 2



5

Expansion formulae



Let's recall.

We have studied the following expansion formulae in previous standard.

$$(i) (a + b)^2 = a^2 + 2ab + b^2, \quad (ii) (a - b)^2 = a^2 - 2ab + b^2,$$

$$(iii) (a + b)(a - b) = a^2 - b^2$$

Use the above formulae to fill proper terms in the following boxes.

$$(i) (x + 2y)^2 = x^2 + \boxed{} + 4y^2$$

$$(ii) (2x - 5y)^2 = \boxed{} - 20xy + \boxed{}$$

$$(iii) (101)^2 = (100 + 1)^2 = \boxed{} + \boxed{} + 1^2 = \boxed{}$$

$$(iv) (98)^2 = (100 - 2)^2 = 10000 - \boxed{} + \boxed{} = \boxed{}$$

$$(v) (5m + 3n)(5m - 3n) = \boxed{} - \boxed{} = \boxed{} - \boxed{}$$



Let's learn.

Activity : Expand $(x + a)(x + b)$ using formulae for areas of a square and a rectangle.

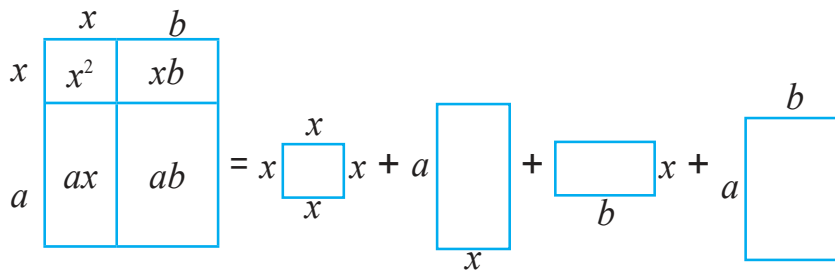

$$(x + a)(x + b) = x^2 + ax + bx + ab$$

$$(x + a)(x + b) = x^2 + (a + b)x + ab$$

(I) Expansion of $(x + a)(x + b)$

$(x + a)$ and $(x + b)$ are binomials with one term in common. Let us multiply them.

$$(x + a)(x + b) = x(x + b) + a(x + b) = x^2 + bx + ax + ab$$

$$= x^2 + (a + b)x + ab$$

$$\therefore \boxed{(x + a)(x + b) = x^2 + (a + b)x + ab}$$

Expand

Ex. (1) $(x + 2)(x + 3) = x^2 + (2 + 3)x + (2 \times 3) = x^2 + 5x + 6$

Ex. (2) $(y + 4)(y - 3) = y^2 + (4 - 3)y + (4) \times (-3) = y^2 + y - 12$

Ex. (3) $(2a + 3b)(2a - 3b) = (2a)^2 + [(3b) + (-3b)]2a + [3b \times (-3b)]$
 $= 4a^2 + 0 \times 2a - 9b^2 = 4a^2 - 9b^2$

Ex. (4) $\left(m + \frac{3}{2}\right)\left(m + \frac{1}{2}\right) = m^2 + \left(\frac{3}{2} + \frac{1}{2}\right)m + \frac{3}{2} \times \frac{1}{2} = m^2 + 2m + \frac{3}{4}$

Ex. (5) $(x - 3)(x - 7) = x^2 + (-3 - 7)x + (-3)(-7) = x^2 - 10x + 21$

Practice Set 5.1

1. Expand.

(1) $(a + 2)(a - 1)$

(2) $(m - 4)(m + 6)$

(3) $(p + 8)(p - 3)$

(4) $(13 + x)(13 - x)$

(5) $(3x + 4y)(3x + 5y)$

(6) $(9x - 5t)(9x + 3t)$

(7) $\left(m + \frac{2}{3}\right)\left(m - \frac{7}{3}\right)$

(8) $\left(x + \frac{1}{x}\right)\left(x - \frac{1}{x}\right)$

(9) $\left(\frac{1}{y} + 4\right)\left(\frac{1}{y} - 9\right)$

 Let's learn.

(II) Expansion of $(a + b)^3$

$$\begin{aligned}(a + b)^3 &= (a + b)(a + b)(a + b) = (a + b)(a + b)^2 \\ &= (a + b)(a^2 + 2ab + b^2) \\ &= a(a^2 + 2ab + b^2) + b(a^2 + 2ab + b^2) \\ &= a^3 + 2a^2b + ab^2 + ba^2 + 2ab^2 + b^3 \\ &= a^3 + 3a^2b + 3ab^2 + b^3\end{aligned}$$

$$\therefore \boxed{(a + b)^3 = a^3 + 3a^2b + 3ab^2 + b^3}$$

Let us study some examples based on the above expansion formula.

Ex. (1) $(x + 3)^3$

We know that $(a + b)^3 = a^3 + 3a^2b + 3ab^2 + b^3$

In the given example, $a = x$ and $b = 3$

$$\begin{aligned}\therefore (x + 3)^3 &= (x)^3 + 3 \times x^2 \times 3 + 3 \times x \times (3)^2 + (3)^3 \\ &= x^3 + 9x^2 + 27x + 27\end{aligned}$$

Ex. (2) $(3x + 4y)^3 = (3x)^3 + 3(3x)^2(4y) + 3(3x)(4y)^2 + (4y)^3$
 $= 27x^3 + 3 \times 9x^2 \times 4y + 3 \times 3x \times 16y^2 + 64y^3$
 $= 27x^3 + 108x^2y + 144xy^2 + 64y^3$

Ex. (3) $\left(\frac{2m}{n} + \frac{n}{2m}\right)^3 = \left(\frac{2m}{n}\right)^3 + 3\left(\frac{2m}{n}\right)^2\left(\frac{n}{2m}\right) + 3\left(\frac{2m}{n}\right)\left(\frac{n}{2m}\right)^2 + \left(\frac{n}{2m}\right)^3$
 $= \frac{8m^3}{n^3} + 3\left(\frac{4m^2}{n^2}\right)\left(\frac{n}{2m}\right) + 3\left(\frac{2m}{n}\right)\left(\frac{n^2}{4m^2}\right) + \frac{n^3}{8m^3}$
 $= \frac{8m^3}{n^3} + \frac{6m}{n} + \frac{3n}{2m} + \frac{n^3}{8m^3}$

Ex. (4) $(41)^3 = (40 + 1)^3 = (40)^3 + 3 \times (40)^2 \times 1 + 3 \times 40 \times (1)^2 + (1)^3$
 $= 64000 + 4800 + 120 + 1 = 68921$

Practice Set 5.2

1. Expand.

- | | | | |
|-----------------|--------------------------------------|---------------------------------------|--|
| (1) $(k + 4)^3$ | (2) $(7x + 8y)^3$ | (3) $(7 + m)^3$ | (4) $(52)^3$ |
| (5) $(101)^3$ | (6) $\left(x + \frac{1}{x}\right)^3$ | (7) $\left(2m + \frac{1}{5}\right)^3$ | (8) $\left(\frac{5x}{y} + \frac{y}{5x}\right)^3$ |

Activity : Make two cubes of side a and of side b each. Make six parallelepipeds; three of them measuring $a \times a \times b$ and the remaining three measuring $b \times b \times a$. Arrange all these solid figures properly and make a cube of side $(a + b)$.



Let's learn.

(III) Expansion of $(a - b)^3$

$$\begin{aligned}\therefore (a - b)^3 &= (a - b)(a - b)(a - b) = (a - b)(a - b)^2 \\ &= (a - b)(a^2 - 2ab + b^2) \\ &= a(a^2 - 2ab + b^2) - b(a^2 - 2ab + b^2)\end{aligned}$$

$$= a^3 - 2a^2b + ab^2 - a^2b + 2ab^2 - b^3$$

$$= a^3 - 3a^2b + 3ab^2 - b^3$$

$$\therefore \boxed{(a - b)^3 = a^3 - 3a^2b + 3ab^2 - b^3}$$

Ex. (1) Expand $(x - 2)^3$

$$(a - b)^3 = a^3 - 3a^2b + 3ab^2 - b^3 \quad \text{Here taking , } a = x \text{ and } b = 2,$$

$$(x - 2)^3 = (x)^3 - 3 \times x^2 \times 2 + 3 \times x \times (2)^2 - (2)^3$$

$$= x^3 - 6x^2 + 12x - 8$$

Ex. (2) Expand $(4p - 5q)^3$.

$$(4p - 5q)^3 = (4p)^3 - 3(4p)^2(5q) + 3(4p)(5q)^2 - (5q)^3$$

$$(4p - 5q)^3 = 64p^3 - 240p^2q + 300pq^2 - 125q^3$$

Ex. (3) Find cube of 99 using the expansion formula.

$$(99)^3 = (100 - 1)^3 = (100)^3 - 3 \times (100)^2 \times 1 + 3 \times 100 \times (1)^2 - 1^3$$

$$= 1000000 - 30000 + 300 - 1 = 9,70,299$$

Ex. (4) Simplify.

$$\begin{aligned} \text{(i) } (p + q)^3 + (p - q)^3 &= p^3 + 3p^2q + 3pq^2 + q^3 + p^3 - 3p^2q + 3pq^2 - q^3 \\ &= 2p^3 + 6pq^2 \end{aligned}$$

$$\begin{aligned} \text{(ii) } (2x + 3y)^3 - (2x - 3y)^3 &= [(2x)^3 + 3(2x)^2(3y) + 3(2x)(3y)^2 + (3y)^3] \\ &\quad - [(2x)^3 - 3(2x)^2(3y) + 3(2x)(3y)^2 - (3y)^3] \\ &= (8x^3 + 36x^2y + 54xy^2 + 27y^3) - (8x^3 - 36x^2y + 54xy^2 - 27y^3) \\ &= 8x^3 + 36x^2y + 54xy^2 + 27y^3 - 8x^3 + 36x^2y - 54xy^2 + 27y^3 \\ &= 72x^2y + 54y^3 \end{aligned}$$



Now I know.

$$\text{(i) } (a + b)^3 = a^3 + 3a^2b + 3ab^2 + b^3 = a^3 + b^3 + 3ab(a + b)$$

$$\text{(ii) } (a - b)^3 = a^3 - 3a^2b + 3ab^2 - b^3 = a^3 - b^3 - 3ab(a - b)$$

Practice Set 5.3

1. Expand.

$$\begin{array}{llll}
 (1) (2m - 5)^3 & (2) (4 - p)^3 & (3) (7x - 9y)^3 & (4) (58)^3 \\
 (5) (198)^3 & (6) \left(2p - \frac{1}{2p}\right)^3 & (7) \left(1 - \frac{1}{a}\right)^3 & (8) \left(\frac{x}{3} - \frac{3}{x}\right)^3
 \end{array}$$

2. Simplify.

$$\begin{array}{ll}
 (1) (2a + b)^3 - (2a - b)^3 & (2) (3r - 2k)^3 + (3r + 2k)^3 \\
 (3) (4a - 3)^3 - (4a + 3)^3 & (4) (5x - 7y)^3 + (5x + 7y)^3
 \end{array}$$



Let's learn.

(IV) Expansion of $(a + b + c)^2$

$$\begin{aligned}
 (a + b + c)^2 &= (a + b + c) \times (a + b + c) \\
 &= a(a + b + c) + b(a + b + c) + c(a + b + c) \\
 &= a^2 + ab + ac + ab + b^2 + bc + ac + bc + c^2 \\
 &= a^2 + b^2 + c^2 + 2ab + 2bc + 2ac
 \end{aligned}$$

$$\therefore \boxed{(a + b + c)^2 = a^2 + b^2 + c^2 + 2ab + 2bc + 2ac.}$$

Ex. (1) Expand: $(p + q + 3)^2$

$$\begin{aligned}
 &= p^2 + q^2 + (3)^2 + 2 \times p \times q + 2 \times q \times 3 + 2 \times p \times 3 \\
 &= p^2 + q^2 + 9 + 2pq + 6q + 6p = p^2 + q^2 + 2pq + 6q + 6p + 9
 \end{aligned}$$

Ex. (2) Fill in the boxes with appropriate terms in the steps of expansion.

$$\begin{aligned}
 &(2p + 3m + 4n)^2 \\
 &= (2p)^2 + (3m)^2 + \boxed{} + 2 \times 2p \times 3m + 2 \times \boxed{} \times 4n + 2 \times 2p \times \boxed{} \\
 &= \boxed{} + 9m^2 + \boxed{} + 12pm + \boxed{} + \boxed{}
 \end{aligned}$$

Ex. (3) Simplify $(l + 2m + n)^2 + (l - 2m + n)^2$

$$\begin{aligned}
 &= l^2 + 4m^2 + n^2 + 4lm + 4mn + 2ln + l^2 + 4m^2 + n^2 - 4lm - 4mn + 2ln \\
 &= 2l^2 + 8m^2 + 2n^2 + 4ln
 \end{aligned}$$

Practice Set 5.4

1. Expand. (1) $(2p + q + 5)^2$ (2) $(m + 2n + 3r)^2$
 (3) $(3x + 4y - 5p)^2$ (4) $(7m - 3n - 4k)^2$
2. Simplify. (1) $(x - 2y + 3)^2 + (x + 2y - 3)^2$
 (2) $(3k - 4r - 2m)^2 - (3k + 4r - 2m)^2$ (3) $(7a - 6b + 5c)^2 + (7a + 6b - 5c)^2$



Answers

- Practice Set 5.1** (1) $a^2 + a - 2$ (2) $m^2 + 2m - 24$ (3) $p^2 + 5p - 24$
 (4) $169 - x^2$ (5) $9x^2 + 27xy + 20y^2$ (6) $81x^2 - 18xt - 15t^2$
 (7) $m^2 - \frac{5}{3}m - \frac{14}{9}$ (6) $x^2 - \frac{1}{x^2}$ (9) $\frac{1}{y^2} - \frac{5}{y} - 36$

- Practice Set 5.2** (1) $k^3 + 12k^2 + 48k + 64$ (2) $343x^3 + 1176x^2y + 1344xy^2 + 512y^3$
 (2) $343 + 147m + 21m^2 + m^3$ (4) 140608 (5) 1030301
 (6) $x^3 + 3x + \frac{3}{x} + \frac{1}{x^3}$ (7) $8m^3 + \frac{12m^2}{5} + \frac{6m}{25} + \frac{1}{125}$
 (8) $\frac{125x^3}{y^3} + \frac{15x}{y} + \frac{3y}{5x} + \frac{y^3}{125x^3}$

- Practice Set 5.3** 1. (1) $8m^3 - 60m^2 + 150m - 125$ (2) $64 - 48p + 12p^2 - p^3$
 (3) $343x^3 - 1323x^2y + 1701xy^2 - 729y^3$ (4) 1,95,112
 (5) 77,62,392 (6) $8p^3 - 6p + \frac{3}{2p} - \frac{1}{8p^3}$
 (7) $1 - \frac{3}{a} + \frac{3}{a^2} - \frac{1}{a^3}$ (8) $\frac{x^3}{27} - x + \frac{9}{x} - \frac{27}{x^3}$
2. (1) $24a^2b + 2b^3$ (2) $54r^3 + 72rk^2$
 (3) $-288a^2 - 54$ (4) $250x^3 + 1470xy^2$

- Practice Set 5.4** 1. (1) $4p^2 + q^2 + 25 + 4pq + 10q + 20p$
 (2) $m^2 + 4n^2 + 9r^2 + 4mn + 12nr + 6mr$
 (3) $9x^2 + 16y^2 + 25p^2 + 24xy - 40py - 30px$
 (4) $49m^2 + 9n^2 + 16k^2 - 42mn + 24nk - 56km$
2. (1) $2x^2 + 8y^2 + 18 - 24y$ (2) $32rm - 48kr$
 (3) $98a^2 + 72b^2 + 50c^2 - 120bc$

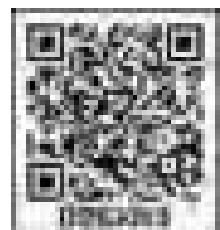

6

Factorisation of Algebraic expressions



Let's recall.

In the previous standard we have learnt to factorise the expressions of the form $ax + ay$ and $a^2 - b^2$

For example, (1) $4xy + 8xy^2 = 4xy(1 + 2y)$

$$(2) p^2 - 9q^2 = (p)^2 - (3q)^2 = (p + 3q)(p - 3q)$$



Let's learn.

Factors of a quadratic trinomial

An expression of the form $ax^2 + bx + c$ is called a quadratic trinomial.

We know that $(x + a)(x + b) = x^2 + (a + b)x + ab$

\therefore the factors of $x^2 + (a + b)x + ab$ are $(x + a)$ and $(x + b)$.

To find the factors of $x^2 + 5x + 6$, by comparing it with $x^2 + (a + b)x + ab$ we get, $a + b = 5$ and $ab = 6$. So, let us find the factors of 6 whose sum is 5. Then writing the trinomial in the form $x^2 + (a + b)x + ab$, find its factors.

$$\begin{aligned} x^2 + 5x + 6 &= x^2 + (3 + 2)x + 3 \times 2 && \dots\dots\dots x^2 + (a + b)x + ab \\ &= \underline{x^2 + 3x} + \underline{2x + 2 \times 3} && \dots\dots\dots \text{multiply } (3 + 2) \text{ by } x, \text{ make two} \\ &&& \text{groups of the four terms obtained.} \\ &= x(x + 3) + 2(x + 3) = (x + 3)(x + 2) \end{aligned}$$

Study the following examples to know how a given trinomial is factorised.

Ex. (1) Factorise : $2x^2 - 9x + 9$.

Solution: First we find the product of the coefficient of the square term and the constant term. Here the product is $2 \times 9 = 18$.

Now, find factors of 18 whose sum is -9 , that is equal to the coefficient of the middle term.

$$18 = (-6) \times (-3) ; (-6) + (-3) = -9$$

Write the term $-9x$ as $-6x - 3x$

$$\begin{aligned} &2x^2 - 9x + 9 \\ &= \underline{2x^2 - 6x} - \underline{3x + 9} \\ &= 2x(x - 3) - 3(x - 3) \\ &= (x - 3)(2x - 3) \end{aligned}$$

$$\therefore 2x^2 - 9x + 9 = (x - 3)(2x - 3)$$

Ex. (2) Factorise : $2x^2 + 5x - 18$.

Solution : $2x^2 + 5x - 18$
 $= \frac{2x^2 + 9x - 4x - 18}{+9 \quad -4}$
 $= x(2x + 9) - 2(2x + 9)$
 $= (2x + 9)(x - 2)$

Ex. (3) Factorise : $x^2 - 10x + 21$.

solution: $x^2 - 10x + 21$
 $= \frac{x^2 - 7x - 3x + 21}{-7 \quad -3}$
 $= x(x - 7) - 3(x - 7)$
 $= (x - 7)(x - 3)$

Ex. (4) Find the factors of $2y^2 - 4y - 30$.

Solution : $2y^2 - 4y - 30$
 $= 2(y^2 - 2y - 15)$ taking out the common factor 2
 $= 2(\underline{y^2 - 5y} + \underline{3y - 15})$
 $= 2[y(y - 5) + 3(y - 5)]$
 $= 2(y - 5)(y + 3)$

Practice Set 6.1

1. Factorise.

- | | | |
|-----------------------|------------------------|-----------------------|
| (1) $x^2 + 9x + 18$ | (2) $x^2 - 10x + 9$ | (3) $y^2 + 24y + 144$ |
| (4) $5y^2 + 5y - 10$ | (5) $p^2 - 2p - 35$ | (6) $p^2 - 7p - 44$ |
| (7) $m^2 - 23m + 120$ | (8) $m^2 - 25m + 100$ | (9) $3x^2 + 14x + 15$ |
| (10) $2x^2 + x - 45$ | (11) $20x^2 - 26x + 8$ | (12) $44x^2 - x - 3$ |



Let's learn.

Factors of $a^3 + b^3$

We know that, $(a + b)^3 = a^3 + 3a^2b + 3ab^2 + b^3$, which we can write as

$$(a + b)^3 = a^3 + b^3 + 3ab(a + b)$$

Now, $a^3 + b^3 + 3ab(a + b) = (a + b)^3$ interchanging the sides.

$$\begin{aligned} \therefore a^3 + b^3 &= (a + b)^3 - 3ab(a + b) = [(a + b)(a + b)^2] - 3ab(a + b) \\ &= (a + b)[(a + b)^2 - 3ab] = (a + b)(a^2 + 2ab + b^2 - 3ab) \\ &= (a + b)(a^2 - ab + b^2) \end{aligned}$$

$$\therefore \boxed{a^3 + b^3 = (a + b)(a^2 - ab + b^2)}$$

Lets us solve some examples using the above formula for factorising the addition of two cubes.

$$\begin{aligned}\text{Ex. (1)} \quad x^3 + 27y^3 &= x^3 + (3y)^3 \\ &= (x + 3y) [x^2 - x(3y) + (3y)^2] \\ &= (x + 3y) [x^2 - 3xy + 9y^2]\end{aligned}$$

$$\begin{aligned}\text{Ex. (2)} \quad 8p^3 + 125q^3 &= (2p)^3 + (5q)^3 = (2p + 5q) [(2p)^2 - 2p \times 5q + (5q)^2] \\ &= (2p + 5q) (4p^2 - 10pq + 25q^2)\end{aligned}$$

$$\begin{aligned}\text{Ex. (3)} \quad m^3 + \frac{1}{64m^3} &= m^3 + \left(\frac{1}{4m}\right)^3 = \left(m + \frac{1}{4m}\right) \left[m^2 - m \times \frac{1}{4m} + \left(\frac{1}{4m}\right)^2\right] \\ &= \left(m + \frac{1}{4m}\right) \left(m^2 - \frac{1}{4} + \frac{1}{16m^2}\right)\end{aligned}$$

$$\begin{aligned}\text{Ex. (4)} \quad 250p^3 + 432q^3 &= 2(125p^3 + 216q^3) \\ &= 2[(5p)^3 + (6q)^3] = 2(5p + 6q)(25p^2 - 30pq + 36q^2)\end{aligned}$$

Practice Set 6.2

1. Factorise. (1) $x^3 + 64y^3$ (2) $125p^3 + q^3$ (3) $125k^3 + 27m^3$ (4) $2l^3 + 432m^3$
 (5) $24a^3 + 81b^3$ (6) $y^3 + \frac{1}{8y^3}$ (7) $a^3 + \frac{8}{a^3}$ (8) $1 + \frac{q^3}{125}$



Let's learn.

Factors of $a^3 - b^3$

$$(a - b)^3 = a^3 - 3a^2b + 3ab^2 - b^3 = a^3 - b^3 - 3ab(a - b)$$

$$\text{Now, } a^3 - b^3 - 3ab(a - b) = (a - b)^3$$

$$\begin{aligned}\therefore a^3 - b^3 &= (a - b)^3 + 3ab(a - b) \\ &= [(a - b)(a - b)^2 + 3ab(a - b)] \\ &= (a - b) [(a - b)^2 + 3ab] \\ &= (a - b) (a^2 - 2ab + b^2 + 3ab) \\ &= (a - b) (a^2 + ab + b^2)\end{aligned}$$

$$\therefore \boxed{a^3 - b^3 = (a - b)(a^2 + ab + b^2)}$$

Lets us solve some examples using the above formula for factorising the difference of two cubes.

$$\begin{aligned} \text{Ex. (1)} \quad x^3 - 8y^3 &= x^3 - (2y)^3 \\ \therefore x^3 - 8y^3 &= x^3 - (2y)^3 \\ &= (x - 2y)(x^2 + 2xy + 4y^2) \end{aligned}$$

$$\text{Ex. (2)} \quad 27p^3 - 125q^3 = (3p)^3 - (5q)^3 = (3p - 5q)(9p^2 + 15pq + 25q^2)$$

$$\begin{aligned} \text{Ex. (3)} \quad 54p^3 - 250q^3 &= 2[27p^3 - 125q^3] = 2[(3p)^3 - (5q)^3] \\ &= 2(3p - 5q)(9p^2 + 15pq + 25q^2) \end{aligned}$$

$$\text{Ex. (4)} \quad a^3 - \frac{1}{a^3} = \left(a - \frac{1}{a}\right) \left(a^2 + 1 + \frac{1}{a^2}\right)$$

$$\text{Ex. (5)} \quad \text{Simplify : } (a - b)^3 - (a^3 - b^3)$$

$$\text{Solution : } (a - b)^3 - (a^3 - b^3) = a^3 - 3a^2b + 3ab^2 - b^3 - a^3 + b^3 = -3a^2b + 3ab^2$$

$$\text{Ex. (6)} \quad \text{Simplify : } (2x + 3y)^3 - (2x - 3y)^3$$

$$\text{Solution : Using the formula } a^3 - b^3 = (a - b)(a^2 + ab + b^2)$$

$$\begin{aligned} \therefore (2x + 3y)^3 - (2x - 3y)^3 &= [(2x + 3y) - (2x - 3y)][(2x + 3y)^2 + (2x + 3y)(2x - 3y) + (2x - 3y)^2] \\ &= [2x + 3y - 2x + 3y][4x^2 + 12xy + 9y^2 + 4x^2 - 9y^2 + 4x^2 - 12xy + 9y^2] \\ &= 6y(12x^2 + 9y^2) = 72x^2y + 54y^3 \end{aligned}$$



Now I know.

$$(i) a^3 + b^3 = (a + b)(a^2 - ab + b^2) \quad (ii) a^3 - b^3 = (a - b)(a^2 + ab + b^2)$$

Practice Set 6.3

$$1. \text{ Factorise : } (1) y^3 - 27 \quad (2) x^3 - 64y^3 \quad (3) 27m^3 - 216n^3 \quad (4) 125y^3 - 1$$

$$(5) 8p^3 - \frac{27}{p^3} \quad (6) 343a^3 - 512b^3 \quad (7) 64x^3 - 729y^3 \quad (8) 16a^3 - \frac{128}{b^3}$$

$$2. \text{ Simplify : } (1) (x + y)^3 - (x - y)^3 \quad (2) (3a + 5b)^3 - (3a - 5b)^3$$

$$(3) (a + b)^3 - a^3 - b^3 \quad (4) p^3 - (p + 1)^3$$

$$(5) (3xy - 2ab)^3 - (3xy + 2ab)^3$$

**Rational algebraic expressions**

If A and B are two algebraic expressions then $\frac{A}{B}$ is called a rational algebraic expression. While simplifying a rational algebraic expression, we have to perform operations of addition, subtraction, multiplication and division. They are similar to those performed on rational numbers.

Note that, the denominators or the divisors of algebraic expressions are non-zero.

Ex. (1) Simplify : $\frac{a^2 + 5a + 6}{a^2 - a - 12} \times \frac{a - 4}{a^2 - 4}$

Solution:
$$\begin{aligned} & \frac{a^2 + 5a + 6}{a^2 - a - 12} \times \frac{a - 4}{a^2 - 4} \\ &= \frac{(a + 3)(a + 2)}{(a - 4)(a + 3)} \times \frac{(a - 4)}{(a + 2)(a - 2)} \\ &= \frac{1}{a - 2} \end{aligned}$$

Ex. (2) $\frac{7x^2 + 18x + 8}{49x^2 - 16} \times \frac{14x - 8}{x + 2}$

Solution :
$$\begin{aligned} & \frac{7x^2 + 18x + 8}{49x^2 - 16} \times \frac{14x - 8}{x + 2} \\ &= \frac{(7x + 4)(x + 2)}{(7x + 4)(7x - 4)} \times \frac{2(7x - 4)}{(x + 2)} \\ &= 2 \end{aligned}$$

Ex. (3) Simplify : $\frac{x^2 - 9y^2}{x^3 - 27y^3}$

Solution:
$$\frac{x^2 - 9y^2}{x^3 - 27y^3} = \frac{(x + 3y)(x - 3y)}{(x - 3y)(x^2 + 3xy + 9y^2)} = \frac{x + 3y}{x^2 + 3xy + 9y^2}$$

Practice Set 6.4

1. Simplify :

(1) $\frac{m^2 - n^2}{(m + n)^2} \times \frac{m^2 + mn + n^2}{m^3 - n^3}$

(2) $\frac{a^2 + 10a + 21}{a^2 + 6a - 7} \times \frac{a^2 - 1}{a + 3}$

(3) $\frac{8x^3 - 27y^3}{4x^2 - 9y^2}$

(4) $\frac{x^2 - 5x - 24}{(x + 3)(x + 8)} \times \frac{x^2 - 64}{(x - 8)^2}$

(5) $\frac{3x^2 - x - 2}{x^2 - 7x + 12} \div \frac{3x^2 - 7x - 6}{x^2 - 4}$

(6) $\frac{4x^2 - 11x + 6}{16x^2 - 9}$

(7) $\frac{a^3 - 27}{5a^2 - 16a + 3} \div \frac{a^2 + 3a + 9}{25a^2 - 1}$

(8) $\frac{1 - 2x + x^2}{1 - x^3} \times \frac{1 + x + x^2}{1 + x}$



Answers

Practice Set 6.1

1. (1) $(x + 6)(x + 3)$ (2) $(x - 9)(x - 1)$ (3) $(y + 12)(y + 12)$
(4) $5(y + 2)(y - 1)$ (5) $(p - 7)(p + 5)$ (6) $(p + 4)(p - 11)$
(7) $(m - 15)(m - 8)$ (8) $(m - 20)(m - 5)$ (9) $(x + 3)(3x + 5)$
(10) $(x + 5)(2x - 9)$ (11) $2(5x - 4)(2x - 1)$ (12) $(11x - 3)(4x + 1)$

Practice Set 6.2

1. (1) $(x + 4y)(x^2 - 4xy + 16y^2)$ (2) $(5p + q)(25p^2 - 5pq + q^2)$
(3) $(5k + 3m)(25k^2 - 15km + 9m^2)$ (4) $2(l + 6m)(l^2 - 6lm + 36m^2)$
(5) $3(2a + 3b)(4a^2 - 6ab + 9b^2)$ (6) $\left(y + \frac{1}{2y}\right)\left(y^2 - \frac{1}{2} + \frac{1}{4y^2}\right)$
(7) $\left(a + \frac{2}{a}\right)\left(a^2 - 2 + \frac{4}{a^2}\right)$ (8) $\left(1 + \frac{q}{5}\right)\left(1 - \frac{q}{5} + \frac{q^2}{25}\right)$

Practice Set 6.3

1. (1) $(y - 3)(y^2 + 3y + 9)$ (2) $(x - 4y)(x^2 + 4xy + 16y^2)$
(3) $27(m - 2n)(m^2 + 2mn + 4n^2)$ (4) $(5y - 1)(25y^2 + 5y + 1)$
(5) $\left(2p - \frac{3}{p}\right)\left(4p^2 + 6 + \frac{9}{p^2}\right)$ (6) $(7a - 8b)(49a^2 + 56ab + 64b^2)$
(7) $(4x - 9y)(16x^2 + 36xy + 81y^2)$ (8) $16\left(a - \frac{2}{b}\right)\left(a^2 + \frac{2a}{b} + \frac{4}{b^2}\right)$
2. (1) $6x^2y + 2y^3$ (2) $270a^2b + 250b^3$ (3) $3a^2b + 3ab^2$
(4) $-3p^2 - 3p - 1$ (5) $-108x^2y^2ab - 16a^3b^3$

Practice Set 6.4

1. (1) $\frac{1}{m+n}$ (2) $a + 1$ (3) $\frac{4x^2 + 6xy + 9y^2}{2x + 3y}$
(4) 1 (5) $\frac{(x-1)(x-2)(x+2)}{(x-3)^2(x-4)}$
(6) $\frac{x-2}{4x+3}$ (7) $5a + 1$ (8) $\frac{1-x}{1+x}$



7 Variation

 **Let's recall.**

If the rate of notebooks is ₹ 240 per dozen, what is the cost of 3 notebooks?
 Also find the cost of 9 notebooks ; 24 notebooks and 50 notebooks and complete the following table.

Number of notebooks (x)	12	3	9	24	50	1
Cost (In Rupees) (y)	240	<input type="text"/>	<input type="text"/>	<input type="text"/>	<input type="text"/>	<input type="text" value="20"/>

From the above table we see that the ratio of number of notebooks (x) and their cost (y) in each pair is $\frac{1}{20}$. It is constant. The number of notebooks and their cost are in the same proportion. In such a case, if one number increases then the other number increases in the same proportion.

 **Let's learn.**

Direct variation

The statement ‘ x and y are in the same proportion’ can be written as ‘ x and y are in direct variation’ or ‘there is a direct variation between x and y ’. Using mathematical symbol it can be written as $x \propto y$. [\propto (alpha) is a greek letter, used to denote variation.]

$x \propto y$ is written in the form of equation as $x = ky$, where k is a constant.

$x = ky$ or $\frac{x}{y} = k$ is the equation form of direct variation where k is the constant of variation.

Observe how the following statements are written using the symbol of variation.

(i) Area of a circle is directly proportional to the square of its radius.

If the area of a circle = A , its radius = r , the above statement is written as $A \propto r^2$.

(ii) Pressure of a liquid (p) varies directly as the depth (d) of the liquid ; this statement is written as $p \propto d$.

To understand the method of symbolic representation of direct variation, study the following examples.

Ex. (1) x varies directly as y , when $x = 5$, $y = 30$. Find the constant of variation and equation of variation.

Solution: x varies directly as y , that is as $x \propto y$

$\therefore x = ky$ k is constant of variation.

when $x = 5$, $y = 30$, is given

$\therefore 5 = k \times 30 \therefore k = \frac{1}{6}$ (constant of variation)

\therefore equation of variation is $x = ky$, that is $x = \frac{y}{6}$ or $y = 6x$

Ex. (2) Cost of groundnuts is directly proportional to its weight. If cost of 5 kg groundnuts is ₹ 450 then find the cost of 1 quintal groundnuts.
(1 quintal = 100 kg)

Solution: Let the cost of groundnuts be x and weight of groundnuts be y .

It is given that x varies directly as $y \therefore x \propto y$ or $x = ky$

It is given that when $x = 450$ then $y = 5$, hence we will find k .

$x = ky \qquad \therefore 450 = 5k \qquad \therefore k = 90$ (constant of variation)

\therefore equation of variation is $x = 90y$.

\therefore if $y = 100$, $x = 90 \times 100 = 9000$

\therefore cost of 1 quintal groundnut is ₹ 9000.

Practice Set 7.1

- Write the following statements using the symbol of variation.
 - Circumference (c) of a circle is directly proportional to its radius (r).
 - Consumption of petrol (l) in a car and distance travelled by that car (d) are in direct variation.
- Complete the following table considering that the cost of apples and their number are in direct variation.

Number of apples (x)	1	4	...	12	...
Cost of apples (y)	8	32	56	...	160

- If $m \propto n$ and when $m = 154$, $n = 7$. Find the value of m , when $n = 14$
- If n varies directly as m , complete the following table.

m	3	5	6.5	...	1.25
n	12	20	...	28	...
- y varies directly as square root of x . When $x = 16$, $y = 24$. Find the constant of variation and equation of variation.

6. The total remuneration paid to labourers, employed to harvest soyabean is in direct variation with the number of labourers. If remuneration of 4 labourers is ₹ 1000, find the remuneration of 17 labourers.



Let's recall.

The following table shows the number of rows and number of students in each row when they are made to stand for drill.

Number of students in a row	40	10	24	12	8
Number of Rows	6	24	10	20	30

From the table we observe that the product of number of students in each row and total number of rows in each pair is 240 ; which is constant. It means, number of students in a row and number of rows are in inverse proportion.

In a pair of numbers, if the increase in one number causes decrease in the other number in the same proportion, the pair is in inverse variation. In such an example, if one number of the pair is doubled, the other is halved.



Let's learn.

Inverse variation

The statement 'x is inversely proportional to y' can also be expressed as 'there is inverse variation in x and y.' If x and y are in inverse proportion, $x \times y$ is constant. Assuming the constant to be k, it is easy to solve a problem.

If x varies inversely as y then $x \times y$ is constant.

'x inversely varies as y' is written as $x \propto \frac{1}{y}$.

If $x \propto \frac{1}{y}$, $x = \frac{k}{y}$ or $x \times y = k$; this is the equation of variation. k, is the constant of variation.

Solved Examples

Ex. (1) If a varies inversely as b then complete the following table.

a	6	12	15	...
b	20	4
$a \times b$	120	120

Solution: (i) $a \propto \frac{1}{b}$, that is $a \times b = k$

when $a = 6$, $b = 20$ $\therefore k = 6 \times 20 = 120$ (constant of variation)

(ii) If $a = 12, b = ?$

$$a \times b = 120$$

$$\therefore 12 \times b = 120$$

$$\therefore b = 10$$

$$\therefore a = 30$$

(iii) If $a = 15, b = ?$

$$a \times b = 120$$

$$\therefore 15 \times b = 120$$

$$\therefore b = 8$$

(iv) If $b = 4, a = ?$

$$a \times b = 120$$

$$\therefore a \times 4 = 120$$

Ex. (2) $f \propto \frac{1}{d^2}$, when $d = 5, f = 18$

Hence, (i) if $d = 10$ find f .

(ii) when $f = 50$ find d .

Solution: $f \propto \frac{1}{d^2} \therefore f \times d^2 = k$, when $d = 5$ and $f = 18$.

$$\therefore 18 \times 5^2 = k \therefore k = 18 \times 25 = 450 \text{ (constant of variation)}$$

(i) if $d = 10$ then $f = ?$

$$f \times d^2 = 450$$

$$\therefore f \times 10^2 = 450$$

$$\therefore f \times 100 = 450$$

$$\therefore f = 4.5$$

(ii) if $f = 50$, then $d = ?$

$$f \times d^2 = 450$$

$$\therefore 50 \times d^2 = 450$$

$$\therefore d^2 = 9$$

$$\therefore d = 3 \text{ or } d = -3$$

Practice Set 7.2

1. The information about numbers of workers and number of days to complete a work is given in the following table. Complete the table.

Number of workers	30	20		10	
Days	6	9	12		36

2. Find constant of variation and write equation of variation for every example given below.

(1) $p \propto \frac{1}{q}$; if $p = 15$ then $q = 4$ (2) $z \propto \frac{1}{w}$; when $z = 2.5$ then $w = 24$

(3) $s \propto \frac{1}{t^2}$; if $s = 4$ then $t = 5$ (4) $x \propto \frac{1}{\sqrt{y}}$; if $x = 15$ then $y = 9$

3. The boxes are to be filled with apples in a heap. If 24 apples are put in a box then 27 boxes are needed. If 36 apples are filled in a box how many boxes will be needed ?

4. Write the following statements using symbol of variation .
- (1) The wavelength of sound (l) and its frequency (f) are in inverse variation.
- (2) The intensity (I) of light varies inversely with the square of the distance (d) of a screen from the lamp.
5. $x \propto \frac{1}{\sqrt{y}}$ and when $x = 40$ then $y = 16$. If $x = 10$, find y .
6. x varies inversely as y , when $x = 15$ then $y = 10$, if $x = 20$ then $y = ?$



Let's learn.

Time, Work, Speed

Examples related to the number of workers and time taken to finish the work are of inverse variation. Similarly, there are some examples related to the time taken to cover a distance by a vehicle and its uniform speed. Such examples of variation are the examples related to time, work and speed.

Now we will see how to solve such examples of variation.

Ex. (1) 15 women finish the work of harvesting a groundnut crop in 8 days. Find the number of women if the same job is to be completed in 6 days.

Solution: The number of days required to finish a job is inversely proportional to the number of women employed. Let the number of days be d and number of women be n .

$$d \propto \frac{1}{n} \quad \therefore d \times n = k \quad (\text{k is constant})$$

$$\text{If } n = 15, \text{ then } d = 8 \quad \therefore k = d \times n = 15 \times 8 = 120$$

Now let us find n when $d = 6$.

$$d \times n = k$$

$$\therefore d \times n = 120 \quad \therefore 6 \times n = 120, \quad n = 20$$

\therefore 20 women should be employed to finish the work in 6 days

Ex. (2) A vehical running at a speed of 48 km/hr takes 6 hours to complete the journey. How much time will be taken to complete the journey if its speed is 72 km/hr ?

Solution : Let us assume the speed of vehicle to be s and time taken to travel be t .

There is inverse variation in speed and time.

$$s \propto \frac{1}{t} \quad \therefore s \times t = k \text{ (k is constant)}$$

$$k = s \times t = 48 \times 6 = 288 \quad \text{Now, let us find } t \text{ when } s = 72.$$

$$s \times t = 288 \quad \therefore 72 \times t = 288 \quad \therefore t = \frac{288}{72} = 4$$

\therefore time taken to travel the same distance at the speed 72 km/hr is 4 hours.

Practice Set 7.3

- Which of the following statements are of inverse variation ?
 - Number of workers on a job and time taken by them to complete the job.
 - Number of pipes of same size to fill a tank and the time taken by them to fill the tank.
 - Petrol filled in the tank of a vehical and its cost
 - Area of circle and its radius.
- If 15 workers can build a wall in 48 hours, how many workers will be required to do the same work in 30 hours ?
- 120 bags of half litre milk can be filled by a machine within 3 minutes find the time to fill such 1800 bags ?
- A car with speed 60 km/hr takes 8 hours to travel some distance. What should be the increase in the speed if the same distance is to be covered in $7\frac{1}{2}$ hours?



Answers

Practice Set 7.1 1. (1) $c \propto r$ (2) $l \propto d$ 2. $x = 7, x = 20, y = 96$ 3. 308
4. $m = 7, n = 26$ and 5 5. $k = 6, y = 6\sqrt{x}$ 6. ₹ 4250

Practice Set 7.2 1. Number of workers 15 and 5 respectively, days = 18

2. (1) $k = 60, pq = 60$ (2) $k = 60, zw = 60$

(3) $k = 100, st^2 = 100$ (4) $k = 45, x\sqrt{y} = 45$

3. 18 boxes 4. (1) $l \propto \frac{1}{f}$ (2) $I \propto \frac{1}{d^2}$ 5. $y = 256$ 6. $y = 7.5$

Practice Set 7.3 1. inverse variation (1), (2) 2. 24 worker
3. 45 minutes 4. 4 km/hr

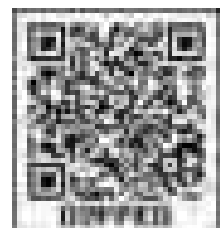

8

Quadrilateral : Constructions and Types



Let's recall.

- Construct the triangles with given measures.
 - (1) $\triangle ABC : l(AB) = 5 \text{ cm}, l(BC) = 5.5 \text{ cm}, l(AC) = 6 \text{ cm}$
 - (2) $\triangle DEF : m \angle D = 35^\circ, m \angle F = 100^\circ, l(DF) = 4.8 \text{ cm}$
 - (3) $\triangle MNP : l(MP) = 6.2 \text{ cm}, l(NP) = 4.5 \text{ cm}, m \angle P = 75^\circ$
 - (4) $\triangle XYZ : m \angle Y = 90^\circ, l(XY) = 4.2 \text{ cm}, l(XZ) = 7 \text{ cm}$
- Every quadrilateral has 4 angles, 4 sides and 2 diagonals. So there are 10 elements of each quadrilateral.

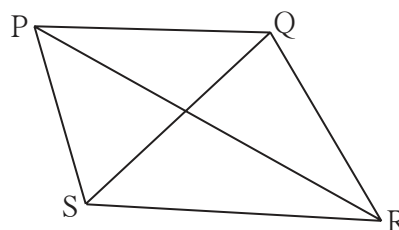

Let's learn.

Construction of a quadrilateral

We can construct a quadrilateral if we know the measures of some specific 5 elements out of 10. Constructions of triangles are the basis of constructions of quadrilaterals. This will be clear from the following examples.

(I) To construct a quadrilateral if the lengths of four sides and a diagonal is given.

Ex. Construct $\square PQRS$ such that , $l(PQ) = 5.6 \text{ cm}$, $l(QR) = 5 \text{ cm}$, $l(PS) = 4.3 \text{ cm}$, $l(RS) = 7 \text{ cm}$, $l(QS) = 6.2 \text{ cm}$

Solution : Let us draw a rough figure and show the given information in it. From the figure we see that the sides of $\triangle SPQ$ and $\triangle SRQ$ are known.

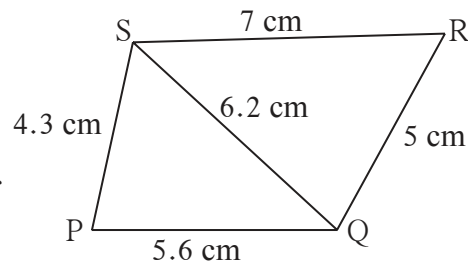

So if we construct $\triangle SPQ$ and $\triangle SRQ$ of given measures, we get $\square PQRS$. Construct the given quadrilateral on your own.

(II) To construct a quadrilateral if three sides and two diagonals are given.

Ex. Construct \square WXYZ such that, $l(YZ) = 4 \text{ cm}$, $l(ZX) = 6 \text{ cm}$,
 $l(WX) = 4.5 \text{ cm}$, $l(ZW) = 5 \text{ cm}$, $l(YW) = 6.5 \text{ cm}$

Solution: Let us draw a rough figure and show the given measures in it.

From the figure we see that all sides of $\triangle WXZ$ and $\triangle WZY$ are known. So let us draw $\triangle WXZ$ and $\triangle WZY$ using given measures. We will get \square WXYZ after drawing segment XY.

Construct this quadrilateral on your own.

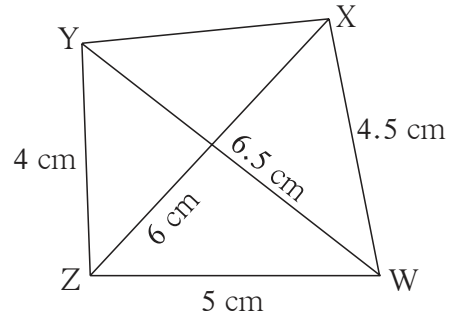

(III) To construct a quadrilateral if two adjacent sides and any three angles are given.

Ex. Construct \square LEFT such that, $l(EL) = 4.5 \text{ cm}$, $l(EF) = 5.5 \text{ cm}$, $m\angle L = 60^\circ$,
 $m\angle E = 100^\circ$, $m\angle F = 120^\circ$

Solution: Let us show the given information in a rough figure. From the figure we see that seg LE of length 4.5 cm can be drawn and after drawing seg EF making an angle of 100° at the point E of seg LE, we get three points L, E and F. Let us draw a rays making an angle of 60° at the point L and a ray making an angle of 120° at the point F. The intersection of these two rays is point T. Now you can construct this \square LEFT.

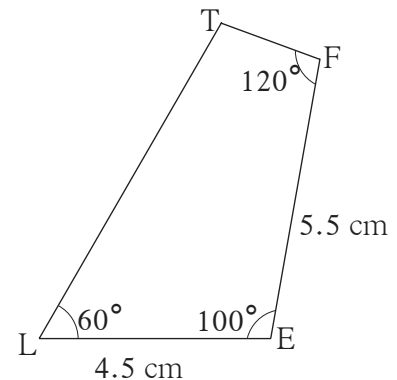

(IV) To construct a quadrilateral if three sides and two angles included by them are given.

Ex. Construct \square PQRS such that, $l(QR) = 5 \text{ cm}$, $l(RS) = 6.2 \text{ cm}$, $l(SP) = 4 \text{ cm}$,
 $m\angle R = 62^\circ$, $m\angle S = 75^\circ$

Solution: Let us draw a rough figure, show the given information in that figure. From the figure we see that after drawing seg QR, if seg RS is drawn making an angle of 62° at the point R, we can get points Q, R and S of the quadrilateral.

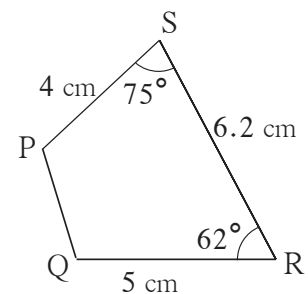

We will get point P on ray SP at a distance of 4 cm from S, which makes an angle of 75° at point S. We get \square PQRS of given measure after joining points P and Q. Now you can do this construction .

Practice Set 8.1

1. Construct the following quadrilaterals of given measures.

- (1) In \square MORE, $l(MO) = 5.8$ cm, $l(OR) = 4.4$ cm, $m\angle M = 58^\circ$, $m\angle O = 105^\circ$, $m\angle R = 90^\circ$.
- (2) Construct \square DEFG such that $l(DE) = 4.5$ cm, $l(EF) = 6.5$ cm, $l(DG) = 5.5$ cm, $l(DF) = 7.2$ cm, $l(EG) = 7.8$ cm.
- (3) In \square ABCD, $l(AB) = 6.4$ cm, $l(BC) = 4.8$ cm, $m\angle A = 70^\circ$, $m\angle B = 50^\circ$, $m\angle C = 140^\circ$.
- (4) Construct \square LMNO such that $l(LM) = l(LO) = 6$ cm, $l(ON) = l(NM) = 4.5$ cm, $l(OM) = 7.5$ cm.



Let's recall.

By putting some conditions on sides and angles of a quadrilateral, we get different types of quadrilaterals. You already know two types of quadrilaterals, namely rectangle and square. Now we will study some more properties of these types and of some more types of quadrilaterals through activities.

Rectangle

If all angles of a quadrilateral are right angles, it is called a rectangle.

Among the five elements given to construct a quadrilateral, at least two have to be lengths of adjacent sides. You can construct a quadrilateral if two adjacent sides and three angles are given.

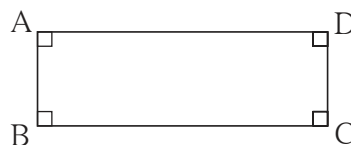

From the definition, we know that all angles of a rectangle are right angles. So if you know two adjacent sides, then you can construct a rectangle.

Activity I : Construct a rectangle PQRS by taking two convenient adjacent sides. Name the point of intersection of diagonals as T. Using divider and ruler, measure the following lengths.

- (1) lengths of opposite sides, seg QR and seg PS.
- (2) length of seg PQ and seg SR
- (3) length of diagonals PR and QS
- (4) lengths of seg PT and seg TR, which are parts of the diagonal PR.
- (5) lengths of seg QT and seg TS, which are parts of the diagonal QS.

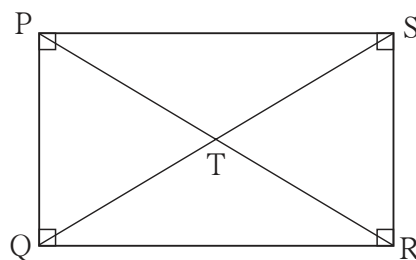

Observe the measures. Discuss about the measures obtained by your classmates. You will come to know the following properties of a rectangle through the discussion.

- Opposite sides of a rectangle are congruent.
- Diagonals of a rectangle are congruent.
- Diagonals of a rectangle bisect each other.

Square

If all sides and all angles of a quadrilateral are congruent, it is called a square.

Activity II : Draw a square of convenient length of side. Name the point of intersection of its diagonals as E. Using the apparatus in a compass box, measure the following lengths.

- (1) lengths of diagonals AC and diagonal BD.
- (2) lengths of two parts of each diagonal made by point E.
- (3) all the angles made at the point E.
- (4) parts of each angle of the square made by each diagonal. (e.g, $\angle ADB$ and $\angle CDB$).

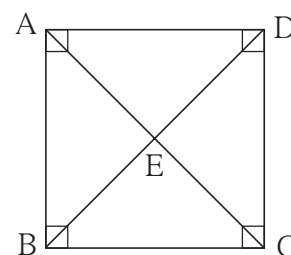

Observe the measures. Also observe the measures obtained by your classmates and discuss about them.

You will get the following properties of a square.

- Diagonals are of equal length. That is they are congruent.
- Diagonals bisect each other.
- Diagonals are perpendicular to each other.
- Diagonals bisect the opposite angles.

Rhombus

If all sides of a quadrilateral are of equal length (congruent), it is called a rhombus.

Activity III : Draw a rhombus EFGH by taking convenient length of side and convenient measure of an angle.
Draw its diagonals and name their point of intersection as M.

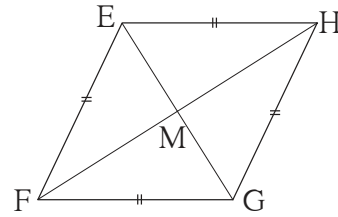

- (1) Measure the opposite angles of the quadrilateral and angles at the point M.
- (2) Measure the two parts of every angle made by the diagonal.
- (3) Measure the lengths of both diagonals. Measure the two parts of diagonals made by point M.

From these measures you will get the following properties of a rhombus.

- Opposite angles are congruent.
 - Diagonals bisect opposite angles of a rhombus.
 - Diagonals bisect each other and they are perpendicular to each other.
- You will see that your classmates also have got the same properties.

Solved Examples

Ex. (1) P is the point of intersection of diagonals of rectangle ABCD. (i) If $l(AB) = 8$ cm then $l(DC) = ?$, (ii) If $l(BP) = 8.5$ cm then find $l(BD)$ and $l(BC)$

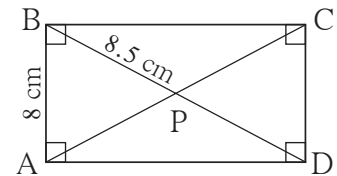

Solution: Let us draw a rough figure and show the given information in it.

(i) Opposite sides of a rectangle are congruent.

$$\therefore l(DC) = l(AB) = 8 \text{ cm}$$

(ii) Diagonals of a rectangle bisect each other.

$$\therefore l(BD) = 2 \times l(BP) = 2 \times 8.5 = 17 \text{ cm}$$

$\triangle BCD$ is a right angled triangle. Using Pythagoras theorem we get,

$$l(BC)^2 = l(BD)^2 - l(CD)^2 = 17^2 - 8^2 = 289 - 64 = 225$$

$$\therefore l(BC) = \sqrt{225} = 15 \text{ cm}$$

Ex.(2) Find the length of a diagonal of a square of side 6 cm.

Solution: Suppose $\square PQRS$ is a square of side 6 cm.
Seg PR is a diagonal.

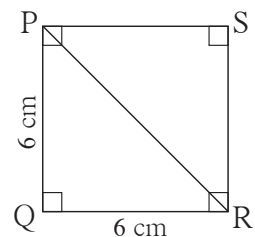

In ΔPQR , using Pythagoras theorem, $l(PR)^2 = l(PQ)^2 + l(QR)^2$
 $= (6)^2 + (6)^2 = 36 + 36 = 72$

$\therefore l(PR) = \sqrt{72}$, \therefore length of the diagonal is $\sqrt{72}$ cm.

Ex. (3) Diagonals of a rhombus BEST intersect at A.

(i) If $m\angle BTS = 110^\circ$, then find $m\angle TBS$

(ii) If $l(TE) = 24$, $l(BS) = 70$, then find $l(TS) = ?$

Solution: Let us draw rough figure of $\square BEST$ and show the point A.

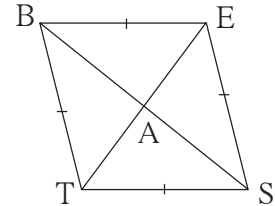

(i) Opposite angles of a rhombus are congruent.

$\therefore m\angle BES = m\angle BTS = 110^\circ$

Now, $m\angle BTS + m\angle BES + m\angle TBE + m\angle TSE = 360^\circ$

$\therefore 110^\circ + 110^\circ + m\angle TBE + m\angle TSE = 360^\circ$

$\therefore m\angle TBE + m\angle TSE = 360^\circ - 220^\circ = 140^\circ$

$\therefore 2 m\angle TBE = 140^\circ \dots \because$ Opposite angles of a rhombus are congruent.

$\therefore m\angle TBE = 70^\circ$

$\therefore m\angle TBS = \frac{1}{2} \times 70^\circ = 35^\circ \dots \because$ diagonal of a rhombus bisects the opposite angles

(ii) Diagonals of a rhombus are perpendicular bisectors of each other.

\therefore In ΔTAS , $m\angle TAS = 90^\circ$

$l(TA) = \frac{1}{2} l(TE) = \frac{1}{2} \times 24 = 12$, $l(AS) = \frac{1}{2} l(BS) = \frac{1}{2} \times 70 = 35$

By Pythagoras theorem,

$l(TS)^2 = l(TA)^2 + l(AS)^2 = (12)^2 + (35)^2 = 144 + 1225 = 1369$

$\therefore l(TS) = \sqrt{1369} = 37$

Practice Set 8.2

1. Draw a rectangle ABCD such that $l(AB) = 6.0$ cm and $l(BC) = 4.5$ cm.
2. Draw a square WXYZ with side 5.2 cm.
3. Draw a rhombus KLMN such that its side is 4 cm and $m\angle K = 75^\circ$.
4. If diagonal of a rectangle is 26 cm and one side is 24 cm, find the other side.

5. Lengths of diagonals of a rhombus ABCD are 16 cm and 12 cm. Find the side and perimeter of the rhombus.
6. Find the length of diagonal of a square with side 8 cm
7. Measure of one angle of a rhombus is 50° , find the measures of remaining three angles.

Parallelogram

A quadrilateral having opposite sides parallel is called a parallelogram.

How can we draw a parallelogram?

Draw seg AB and seg BC making an angle of any measure as shown in the adjacent figure.

You know how to draw a line parallel to a given line through a point which is outside it.

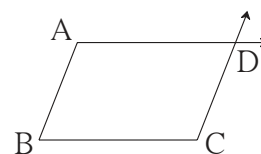

Using the method, draw a line through point C and parallel to the seg AB. Similarly, draw a line parallel to seg BC and passing through point A. Name the point of intersection of the lines as D. \square ABCD is a parallelogram. We know that interior angles made by a transversal of parallel lines are supplementary. So in the above figure $m\angle A + m\angle B = 180^\circ$, $m\angle B + m\angle C = 180^\circ$, $m\angle C + m\angle D = 180^\circ$ and $m\angle D + m\angle A = 180^\circ$ so we get a property of angles of a parallelogram that-

- Adjacent angles of a parallelogram are supplementary.

To know some more properties, draw a parallelogram PQRS as per the **activity**. Take two rulers of different widths, place one ruler horizontally and draw lines along its edges. Now place the other ruler in slant position over the lines drawn and draw lines along its edges. We get a parallelogram. Draw the diagonals of it and name the point of intersection as T.

- (1) Measure the opposite angles of the parallelogram.
- (2) Measure the lengths of opposite sides
- (3) Measure the lengths of diagonals.
- (4) Measure the lengths of parts of the diagonals made by point T.

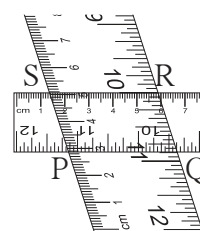

From these measures you will get the following properties of a parallelogram.

- Opposite angles are congruent.
- Opposite sides are congruent.
- Diagonals bisect each other.

Verify the above properties by drawing some more parallelograms.

Trapezium

If only one pair of opposite sides of a quadrilateral is parallel then it is called a trapezium.

In \square WXYZ, only one pair of opposite sides, seg WZ and seg XY is parallel. So by definition \square WXYZ is a trapezium.

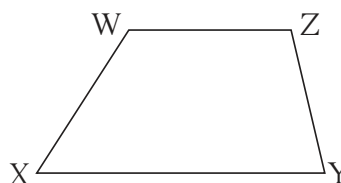

With the property of interior angles formed by two parallel lines and their transversal we get $m\angle W + m\angle X = 180^\circ$ and $m\angle Y + m\angle Z = 180^\circ$

In a trapezium, out of four pairs of adjacent angles, two are supplementary.

Kite

See the figure of \square ABCD. Diagonal BD of the quadrilateral bisects the diagonal AC.

If one diagonal is the perpendicular bisector of the other diagonal then the quadrilateral is called a kite.

In the adjacent figure of \square ABCD, verify with a divider that seg $AB \cong$ seg CB and seg $AD \cong$ seg CD.

Similarly measure $\angle BAD$ and $\angle BCD$ and verify that they are congruent.

Thus we get two properties of a kite.

- Two pairs of adjacent sides are congruent.
- One pair of opposite angles is congruent.

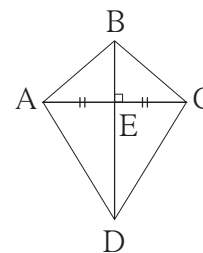

Solved Examples

Ex. (1) Measures of adjacent angles of a parallelogram are $(5x - 7)^\circ$ and $(4x + 25)^\circ$. Find the measures of these angles.

Solution: Adjacent angles of a parallelogram are supplementary.

$$\begin{aligned} \therefore (5x - 7) + (4x + 25) &= 180 & \therefore 9x &= 180 - 18 = 162 \\ \therefore 9x + 18 &= 180 & \therefore x &= 18 \end{aligned}$$

$$\therefore \text{measure of one angle} = (5x - 7)^\circ = 5 \times 18 - 7 = 90 - 7 = 83^\circ$$

$$\text{Measure of the other angle} = (4x + 25)^\circ = 4 \times 18 + 25 = 72 + 25 = 97^\circ$$

Ex. (2) □ PQRS is a parallelogram. T is the point of intersection of its diagonals.

Referring the figure, write the answers of questions given below.

(i) If $l(PS) = 5.4$ cm, then $l(QR) = ?$

(ii) If $l(TS) = 3.5$ cm, then $l(QS) = ?$

(iii) If $m\angle QRS = 118^\circ$, find $m\angle QPS$.

(iv) If $m\angle SRP = 72^\circ$, find $m\angle RPQ$.

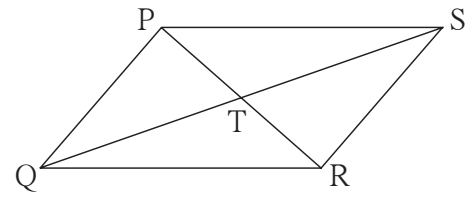

Solution : In parallelogram PQRS,

(i) $l(QR) = l(PS) = 5.4$ cm opposite sides are congruent

(ii) $l(QS) = 2 \times l(TS) = 2 \times 3.5 = 7$ cm diagonals bisect each other

(iii) $m\angle QPS = m\angle QRS = 118^\circ$ opposite angles are congruent

(iv) $m\angle RPQ = m\angle SRP = 72^\circ$ alternate angles are congruent

Ex . (3) Ratio of measures of angles of □ CWPR is 7:9:3:5 then find the measures of its angles and write the type of the quadrilateral.

Solution: Suppose, $m\angle C : m\angle W : m\angle P : m\angle R = 7:9:3:5$

let the measures of $\angle C$, $\angle W$, $\angle P$ and $\angle R$

be $7x$, $9x$, $3x$ and $5x$ respectively.

$$\therefore 7x + 9x + 3x + 5x = 360^\circ$$

$$\therefore 24x = 360^\circ \quad \therefore x = 15$$

$$\therefore m\angle C = 7 \times 15 = 105^\circ, m\angle W = 9 \times 15 = 135^\circ$$

$$m\angle P = 3 \times 15 = 45^\circ \text{ and } m\angle R = 5 \times 15 = 75^\circ$$

$$\therefore m\angle C + m\angle R = 105^\circ + 75^\circ = 180^\circ \quad \therefore \text{side } CW \parallel \text{side } RP$$

$$m\angle C + m\angle W = 105^\circ + 135^\circ = 240^\circ \neq 180^\circ$$

\therefore side CR is not parallel to side WP.

\therefore only one pair of opposite sides of □ CWPR is parallel.

\therefore □ CWPR is a trapezium.

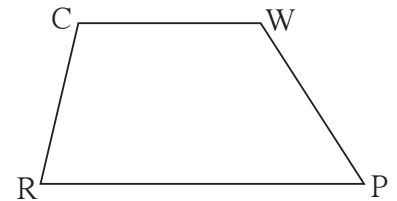

Practice Set 8.3

1. Measures of opposite angles of a parallelogram are $(3x-2)^\circ$ and $(50-x)^\circ$. Find the measure of its each angle.

2. Referring the adjacent figure of a parallelogram, write the answers of questions given below.

(1) If $l(WZ) = 4.5$ cm then $l(XY) = ?$

(2) If $l(YZ) = 8.2$ cm then $l(XW) = ?$

(3) If $l(OX) = 2.5$ cm then $l(OZ) = ?$

(4) If $l(WO) = 3.3$ cm then $l(WY) = ?$

(5) If $m\angle WZY = 120^\circ$ then $m\angle WXY = ?$ and $m\angle XWZ = ?$

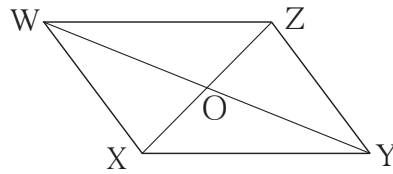

3. Construct a parallelogram ABCD such that $l(BC) = 7$ cm, $m\angle ABC = 40^\circ$, $l(AB) = 3$ cm.

4. Ratio of consecutive angles of a quadrilateral is 1:2:3:4. Find the measure of its each angle. Write, with reason, what type of a quadrilateral it is.

5. Construct \square BARC such that $l(BA) = l(BC) = 4.2$ cm, $l(AC) = 6.0$ cm, $l(AR) = l(CR) = 5.6$ cm

6*. Construct \square PQRS, such that $l(PQ) = 3.5$ cm, $l(QR) = 5.6$ cm, $l(RS) = 3.5$ cm, $m\angle Q = 110^\circ$, $m\angle R = 70^\circ$.

If it is given that \square PQRS is a parallelogram, which of the given information is unnecessary ?



Answers

Practice Set 8.2

4. 10 cm 5. side 10 cm, perimeter 40 cm. 6. $\sqrt{128}$ cm 7. 130° , 50° , 130°

Practice Set 8.3

1. 37° , 143° , 37° , 143°

2. (1) 4.5 cm (2) 8.2 cm (3) 2.5 cm (4) 6.6 cm (5) 120° , 60°

4. 36° , 72° , 108° , 144° , a trapezium

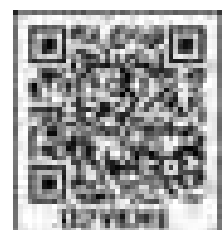

9

Discount and Commission

Let's recall.

Write the appropriate numbers in the following boxes.

1. $\frac{12}{100} = \square$ Percent = \square % 2. $47\% = \frac{\square}{\square}$ 3. $86\% = \frac{\square}{\square}$
4. 4% of $300 = 300 \times \frac{\square}{\square} = \square$ 5. 15% of $1700 = 1700 \times \frac{\square}{\square} = \square$

Let's discuss.



You may have seen such advertisements. In such a sale, a discount is offered on various goods. Generally in the month of July, sales of clothes are declared. Find and discuss the purpose of such sales.

Let's learn.

Discount

Mr. Suresh owns a saree shop. The details of sale of sarees and profit earned, is given in the following table :

Sale in Month	Cost Price of a saree (In Rs)	Selling Price (In Rs.)	Profit on each saree	Number of sarees sold	Total profit of the month
June	200	250	50	40	$50 \times 40 = 2000$
July (Discount)	200	230	30	100	$30 \times 100 = 3000$

From the above table, it is clear that the discount is given on each saree during the sale in July. The profit on each saree is less but the total sarees sold are more hence overall there is more income for Mr. Suresh.

Each item to be sold has a price tag on it. The price on that tag is the ‘ **Marked Price**’ of the item. Shopkeeper offers discount on the marked price. While selling the object, the actual amount by which he reduces the marked price is called the ‘**Discount**’.

Hence the selling price = Marked Price - Discount.

Generally discount is given in terms of the percentage. A ‘20% discount’ implies that, an item should be sold by reducing the marked price by 20%. That is if the marked price of an item is Rs. 100 a discount of Rs. 20 is given on it. Hence the selling price of the item will be $100 - 20 = \text{Rs. } 80$

In such transaction if the discount is $x\%$.

$$\text{then } \frac{x}{100} = \frac{\text{Discount}}{\text{Marked Price}}$$

$$\therefore \text{Discount} = \frac{\text{Marked Price} \times x}{100}$$

For more information:

At present, on line shopping of books, cloths, mobiles etc. is more popular than going to the market.

The companies which sell their goods online, do not have to spend much on shops and managements.

These companies not only give a discount but also give home delivery.

Solved Examples

Ex. (1) The marked price of a book is Rs. 360. The shop keeper sold it for Rs. 306. How much percent discount did the shopkeeper give ?

Solution: Marked Price = ₹ 360, Selling Price = ₹ 306.

$$\therefore \text{Discount} = 360 - 306 = ₹ 54.$$

On marked price of Rs. 360, the discount is 54 rupees.

\therefore if the marked price is ₹ 100, let the discount be x .

$$\frac{\text{Discount}}{\text{Marked price}} = \frac{x}{100} \quad \therefore \frac{54}{360} = \frac{x}{100} \quad \therefore x = \frac{54 \times 100}{360} = 15$$

\therefore 15% discount is given on the book.

Ex. (2) The marked price of a chair is Rs. 1200. A 10% discount is given on it. Calculate the discount and selling price of the chair.

Solution :

Method I

Marked price = ₹ 1200, discount = 10%

Let us find the ratio $\frac{\text{discount}}{\text{marked price}}$

Let us assume that, discount obtained is ₹ x on the marked price of a chair.

$$\begin{aligned}\therefore \frac{x}{1200} &= \frac{10}{100} \\ x &= \frac{10}{100} \times 1200 \\ x &= 120\end{aligned}$$

Discount = ₹ 120.

$$\begin{aligned}\text{Selling Price} &= \text{Marked Price} - \text{Discount} \\ &= 1200 - 120 \\ &= 1080\end{aligned}$$

Selling Price of a chair is ₹ 1080

Method II

10% discount is given on marked price. Therefore, if marked price is ₹ 100, then selling price is ₹ 90.

\therefore when marked price is 1200, let the selling price be ₹ x .

$$\begin{aligned}\therefore \frac{x}{1200} &= \frac{90}{100} \\ \therefore x &= \frac{90}{100} \times \frac{1200}{1}\end{aligned}$$

$\therefore x = 1080$

Selling price of a chair is 1080 rupees.

$$\begin{aligned}\therefore \text{discount} &= 1200 - 1080 \\ &= ₹ 120.\end{aligned}$$

Ex. (3) After giving a discount of 20%, a saree is sold for Rs. 1120. Find the marked price of the saree.

Solution : Suppose, the marked price of the saree was Rs. 100. The discount given was 20%, therefore the customer got it for $100 - 20 = 80$ rupees. That is, if the selling price was 80 rupees, the marked price was 100 rupees. Let us assume that the actual marked price of the saree, which was sold for Rs. 1120, was x .

$$\begin{aligned}\therefore \frac{80}{100} &= \frac{1120}{x} \\ \therefore x &= \frac{1120 \times 100}{80} \\ &= 1400\end{aligned}$$

\therefore marked price of the saree was 1400 rupees.

Ex. (4) A shopkeeper decides to sell a certain item at a certain price. He marks the price of the item, by increasing the decided price by 30%. While selling the item, he offers 20% discount. Find how many percent he gets more on the decided price.

Solution: The percentage increase in price and profit depends upon the decided price of the item. By assuming decided price to be Rs. 100 the solution of the problem will be easy.

∴ let the decided price be ₹ 100.

Therefore, he marks the price as ₹ 130

∴ Marked price = ₹ 130

Discount given = 20% of 130 = $130 \times \frac{20}{100} = ₹ 26$

∴ selling price = 130 - 26 = ₹ 104

∴ if the decided price is ₹ 100, he get ₹ 104.

Hence he gets 4% more than his decided price.

Ex. (5) On a certain item, a shopkeeper gives 8% discount to the customer and still he gets 15% profit. If the marked price of the item is Rs. 1750, then what is the cost price of the item for the shopkeeper ?

Solution : Marked price of the item = ₹ 1750, discount is 8%

∴ total discount = $1750 \times \frac{8}{100} = ₹ 140$

∴ selling price of the item = 1750 - 140 = ₹ 1610

Profit is 15%. Hence if the cost price is Rs. 100 then selling price is Rs.115.

That is, when selling price is Rs. 115, cost price is Rs. 100. So when the selling price is Rs.1610, let the cost price be Rs. x .

$$\therefore \frac{x}{100} = \frac{1610}{115} \quad \therefore x = \frac{1610 \times 100}{115} = 1400$$

∴ cost price of the item = ₹ 1400.



Now I know.

- Selling price = Marked price - Discount
- If the percentage of discount is x , then $\frac{x}{100} = \frac{\text{Discount given}}{\text{Marked price}}$

Practice Set 9.1

1. If marked price = ₹ 1700, selling price = ₹ 1540 then find the discount.
2. If marked price = ₹ 990 and percentage of discount is 10, then find the selling price.
3. If selling price = ₹ 900. Discount is 20 %, then find the marked price.
4. The marked price of the fan is 3000 rupees. Shopkeeper gave 12% discount on it. Find the total discount and selling price of the fan.
5. The marked price of a mixer is 2300 rupees. A customer purchased it for Rs.1955. Find percentage of discount offered to the customer.
6. A shopkeeper gives 11% discount on a television set, hence the cost price of it is Rs. 22,250. Then find the marked price of the television set.
7. After offering discount of 10% on marked price, a customer gets total discount of 17 rupees. To find the cost price for the customer, fill in the following boxes with appropriate numbers and complete the activity.

Suppose, marked price of the item = 100 rupees

Therefore, for customer that item costs - = 90 rupees

Hence, when the discount is then the selling price is rupees.

Suppose when the discount is rupees, the selling price is x rupees.

$$\therefore \frac{x}{\text{input}} = \frac{\text{input}}{\text{input}} \qquad \therefore x = \frac{\text{input} \times \text{input}}{\text{input}} = \text{input}$$

\therefore the customer will get the item for 153 rupees.

8. A shopkeeper decides to sell a certain item at a certain price. He tags the price on the item by increasing the decided price by 25%. While selling the item, he offers 20% discount. Find how many more or less percent he gets on the decided price.



Commission

Sometimes it is not possible for a company to sell their manufactured goods. In such a case the company assigns responsibility of selling the goods. (For example, books, cloth, soap etc.) The person gets some remuneration for the service. The remuneration is called '**Commission**'. The person who provides such type of service

is called a '**Commission agent**'. Commission is decided in terms of percentage. The rates of commission vary according to the types of goods.

If owners of land, house, cattle etc. want to sell the belongings, it is not easy for them to find such customers. In such a situation, the person who brings the seller and the buyer together is known as a 'mediator' or an 'agent' or a 'commission agent'.

Foodgrains, vegetables, fruits and flowers are also sold with the help of a mediator or an 'agent'. For the job the agent gets commission. The commission is received from the seller or the buyer or from both.

Solved Examples

Ex. (1) Shripati sold a land for Rs. 2,50,000 to Mr. Sadashiv through a broker. Broker received 2% brokerage from both. Find the total brokerage received by the broker.

Solution: Price of the land = ₹ 2,50,000

$$\therefore \text{brokerage} = 250000 \times \frac{2}{100} = ₹ 5000$$

brokerage received from both, buyer and seller .

$$\therefore \text{total brokerage} = 5000 + 5000 = 10000 \text{ rupees.}$$

Ex. (2) Sukhdeo sold 10 quintal of wheat at Rs. 4050 per quintal through an agent. The commission was paid at the rate of 1%. Find the amount Sukhdeo received after selling the wheat.

Solution: Selling price of wheat = $10 \times 4050 = ₹ 40500$;

the commission rate = 1%

$$\therefore \text{commission} = 40500 \times \frac{1}{100} = ₹ 405$$

\therefore amount received by selling wheat

$$= \text{selling price of wheat} - \text{commission}$$

$$= 40500 - 405 = ₹ 40,095$$

After selling the wheat, Sukhdeo received 40,095 rupees.

Rebate

The organisations like Khadi - Gramodyog, Handloom shops, Handicraft selling centers, Bachat groups etc. give attractive discounts on special occasions. For example, at the time of Gandhi - Jayanti, the khadi textile goods are discounted for promoting khadi. At such times the amount of discount is compensated by the government. This monetary compensation is known as 'Rebate'. Hence rebate is also a type of discount.

The individuals having income upto certain limit, also receive some discount on their payable income tax. This discount is also known as 'rebate'.

Solved Examples

Ex. From a 'Handloom stores', Sudhir purchased the following items:

(i) 2 bedsheets, Rs. 375 each, (ii) 2 floormats, Rs. 525 each.

On the purchase he received a rebate of 15 percent. Find the total rebate.

How much should Sudhir pay to the shopkeeper?

Solution : Cost of 2 bedsheets = $2 \times 375 = ₹ 750$.

Cost of 2 floormats = $2 \times 525 = ₹ 1050$.

Total cost of items purchased = $750 + 1050 = ₹ 1800$

Total rebate given on marked price = $1800 \times \frac{15}{100} = ₹ 270$

\therefore Sudhir has to pay = $1800 - 270 = ₹ 1530$

Practice Set 9.2

1. John sold books worth rupees 4500 for a publisher. For this he received 15 % commission. Complete the following activity to find the total commission John obtained.

Selling price of books =

Rate of commission =

Commission obtained = $\frac{\text{}}{\text{}} \times \text{$ \therefore Commission = rupees

2. Rafique sold flowers worth ₹ 15,000 by giving 4% commission to the agent. Find the commission he paid. Find the amount received by Rafique.
3. A farmer sold foodgrains for 9200 rupees through an agent. The rate of commission was 2%. How much amount did the agent get?

4. Umatai purchased following items from a Khadi - Bhandar.

(i) 3 sarees for 560 rupees each.

(ii) 6 bottles of honey for 90 rupees each.

On the purchase, she received a rebate of 12%. How much total amount did Umatai pay ?

5. Use the given information and fill in the boxes with suitable numbers.

Smt. Deepanjali purchased a house for ₹ 7,50,000 from Smt. Leelaben through an agent. Agent has charged 2 % brokerage from both of them.

(1) Smt. Deepanjali paid $\square \times \frac{\square}{\square} = ₹ \square$ brokerage for purchasing the house.

(2) Smt. Leelaben paid brokerage of ₹ \square .

(3) Total brokerage received by the agent is ₹ \square .

(4) The cost of house Smt. Deepanjali paid is ₹ \square .

(5) The selling price of house for Smt. Leelaben is ₹ \square .

kkk

Answers

Practice Set 9.1

1. ₹ 160 2. ₹ 891 3. ₹ 1125

4. Discount ₹ 360, Selling Price ₹ 2640 5. 15% 6. ₹ 25,000 8. 0 %.

Practice Set 9.2

2. Discount ₹ 600, amount ₹ 14400 3. ₹ 184 4. ₹ 1953.60

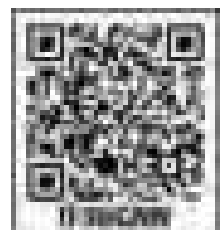

Miscellaneous Exercise 1

- Choose the correct alternative answer for each of the following questions.
 - In \square PQRS, $m\angle P = m\angle R = 108^\circ$, $m\angle Q = m\angle S = 72^\circ$. State which pair of sides of those given below is parallel.
 - Side PQ and side QR
 - side PQ and side SR
 - side SR and side SP
 - side PS and side PQ
 - Read the following statements and choose the correct alternative from those given below them.
 - Diagonals of a rectangle are perpendicular bisectors of each other.
 - Diagonals of a rhombus are perpendicular bisectors of each other.
 - Diagonals of a parallelogram are perpendicular bisectors of each other.
 - Diagonals of a kite bisect each other.
 - Statement (ii) and (iii) are true
 - Only statement (ii) is true
 - Statements (ii) and (iv) are true
 - Statements (i), (iii) and (iv) are true.
 - If $19^3 = 6859$, find $\sqrt[3]{0.006859}$.
 - 1.9
 - 19
 - 0.019
 - 0.19
- Find the cube roots of the following numbers.
 - 5832
 - 4096
- $m \propto n$, $n = 15$ when $m = 25$. Hence
 - Find m when $n = 87$
 - Find n when $m = 155$
- y varies inversely with x . If $y = 30$ when $x = 12$, find
 - y when $x = 15$
 - x when $y = 18$
- Draw a line l . Draw a line parallel to line l at a distance of 3.5 cm.
- Fill in the blanks in the following statement.

The number $(256)^{\frac{5}{7}}$ isth root ofth power of
- Expand.
 - $(5x-7)(5x-9)$
 - $(2x-3y)^3$
 - $(a + \frac{1}{2})^3$

8. Draw an obtuse angled triangle. Draw all of its medians and show their point of concurrence.
9. Draw ΔABC such that $l(BC) = 5.5$ cm, $m \angle ABC = 90^\circ$, $l(AB) = 4$ cm. Show the orthocentre of the triangle.
10. Identify the variation and solve. It takes 5 hours to travel from one town to the other if speed of the bus is 48 km/hr. If the speed of the bus is reduced by 8 km/hr, how much time will it take for the same travel ?
11. Seg AD and seg BE are medians of ΔABC and point G is the centroid. If $l(AG) = 5$ cm, find $l(GD)$. If $l(GE) = 2$ cm, find $l(BE)$.
12. Convert the following rational numbers into decimal form.
 (1) $\frac{8}{13}$ (2) $\frac{11}{7}$ (3) $\frac{5}{16}$ (4) $\frac{7}{9}$
13. Factorise.
 (1) $2y^2 - 11y + 5$ (2) $x^2 - 2x - 80$ (3) $3x^2 - 4x + 1$
14. The marked price of a T. V. Set is ₹ 50000. The shop keeper sold it at 15% discount. Find the price of it for the customer.
15. Rajabhau sold his flat to Vasantrao for ₹ 88,00,000 through an agent. The agent charged 2 % commission for both of them. Find how much commission the agent got.
16. Draw a parallelogram ABCD. such that $l(DC) = 5.5$ cm, $m \angle D = 45^\circ$, $l(AD) = 4$ cm.
17. In the figure, line $l \parallel$ line m and line $p \parallel$ line q . Find the measures of $\angle a$, $\angle b$, $\angle c$ and $\angle d$.

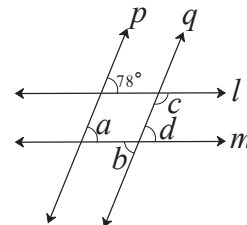

Answers

1. (i) B (ii) B (iii) D 2. (1)18 (2) 16 3. (1) 145 (2) 93
 4. (1) 24 (2) 20 6. 7, 5, 256 in order
 7. (1) $25x^2 - 80x + 63$ (2) $8x^3 - 36x^2y + 54xy^2 - 27y^3$ (3) $a^3 + \frac{3a^2}{2} + \frac{3a}{4} + \frac{1}{8}$
 10. Inverse, 6 hrs 11. $l(GD) = 2.5$ cm, $l(BE) = 6$ cm
 12. (1) $0.\overline{615384}$ (2) $1.\overline{571428}$ (3) 0.3125 (4) $0.\dot{7}$
 13. (1) $(y - 5)(2y - 1)$ (2) $(x - 10)(x + 8)$ (3) $(x - 1)(3x - 1)$
 14. ₹ 42500 15. ₹ 352000 17. $78^\circ, 78^\circ, 102^\circ, 78^\circ$

10

Division of Polynomials

 Let's recall.

Last year we have studied how to perform addition, subtraction and multiplication on algebraic expressions.

Fill in the blanks in the following examples.

(1) $2a + 3a = \square$

(2) $7b - 4b = \square$

(3) $3p \times p^2 = \square$

(4) $5m^2 \times 3m^2 = \square$

(5) $(2x + 5y) \times \frac{3}{x} = \square$

(6) $(3x^2 + 4y) \times (2x + 3y) = \square$

 Let's learn.

Introduction to polynomial

If index of each term of an algebraic expression in one variable is a whole number, then the expression is called a polynomial.

For example, $x^2 + 2x + 3$; $3y^3 + 2y^2 + y + 5$ are polynomials in one variable.

Polynomials are specific algebraic expressions. Hence the operations of addition, subtraction and multiplication on polynomials are similar to those performed on algebraic expressions.

Ex. (1) $(3x^2 - 2x) \times (4x^3 - 3x^2)$

$$= 3x^2(4x^3 - 3x^2) - 2x(4x^3 - 3x^2)$$

$$= 12x^5 - 9x^4 - 8x^4 + 6x^3$$

$$= 12x^5 - 17x^4 + 6x^3$$

(2) $(4x - 5) - (3x^2 - 7x + 8)$

$$= 4x - 5 - 3x^2 + 7x - 8$$

$$= -3x^2 + 4x + 7x - 8$$

$$= -3x^2 + 11x - 13$$

Degree of a polynomial

Write the greatest index of the variable in the following polynomials.

Ex. (1) The greatest index of variable in the polynomial $3x^2 + 4x$ is 2

Ex. (2) The greatest index of a variable in the polynomial

$$7x^3 + 5x + 4x^5 + 2x^2 \text{ is } \square$$

The greatest index of the variable in the given polynomial is called the degree of the polynomial.



Now I know.

- The algebraic expression in one variable is a polynomial if the index of variable of each term is a whole number.
- In a polynomial, the greatest index of the variable is the degree of the polynomial.



Let's learn.

(I) To divide a monomial by a monomial

Ex. (1) Divide : $15p^3 \div 3p$

Solution: Division is the opposite operation of multiplication.

For division $15p^3 \div 3p$, we find the multiplier of $3p$ which will give product $15p^3$.

$$3p \times 5p^2 = 15p^3 \therefore 15p^3 \div 3p = 5p^2$$

$$\begin{array}{r} 5p^2 \\ 3p \overline{) 15p^3} \\ \underline{15p^3} \\ 0 \end{array}$$

Ex. (2) Divide and write the correct terms in the boxes.

(i) $(-36x^4) \div (-9x)$

(ii) $(5m^2) \div (-m)$

(iii) $(-20y^5) \div (2y^3)$

$$\begin{array}{r} \boxed{} \\ -9x \overline{) -36x^4} \\ \underline{} \\ \boxed{} \\ \underline{} \\ \boxed{} \end{array}$$

$$\begin{array}{r} \boxed{} \\ -m \overline{) 5m^2} \\ \underline{} \\ \boxed{} \\ \underline{} \\ \boxed{} \end{array}$$

$$\begin{array}{r} \boxed{} \\ 2y^3 \overline{) -20y^5} \\ \underline{} \\ \boxed{} \\ \underline{} \\ \boxed{} \end{array}$$

To divide a polynomial by a monomial

Study the following examples and learn the method of division of polynomial by a monomial.

Ex. (1) $(6x^3 + 8x^2) \div 2x$

Solution :

$$\begin{array}{r} 3x^2 + 4x \\ 2x \overline{) 6x^3 + 8x^2} \\ \underline{6x^3} \\ 0 + 8x^2 \\ \underline{- 8x^2} \\ 0 \end{array}$$

Explanation -

(i) $2x \times \boxed{3x^2} = 6x^3$

(ii) $2x \times \boxed{4x} = 8x^2$

\therefore Quotient = $3x^2 + 4x$

Remainder = 0

Ex. (2) $(15y^4 + 10y^3 - 3y^2) \div 5y^2$

Solution :

$$\begin{array}{r} 3y^2 + 2y - \frac{3}{5} \\ 5y^2 \overline{)15y^4 + 10y^3 - 3y^2} \\ \underline{-15y^4} \\ 0 + 10y^3 - 3y^2 \\ \underline{-10y^3} \\ 0 - 3y^2 \\ \underline{+3y^2} \\ 0 \end{array}$$

\therefore Quotient = $3y^2 + 2y - \frac{3}{5}$

Explanation -

(i) $5y^2 \times 3y^2 = 15y^4$

(ii) $5y^2 \times 2y = 10y^3$

(iii) $5y^2 \times \frac{-3}{5} = -3y^2$

Remainder = 0

Ex. (3) $(12p^3 - 6p^2 + 4p) \div 3p^2$

Solution :

$$\begin{array}{r} 4p - 2 \\ 3p^2 \overline{)12p^3 - 6p^2 + 4p} \\ \underline{-12p^3} \\ 0 - 6p^2 + 4p \\ \underline{+6p^2} \\ 0 + 4p \end{array}$$

Explanation -

(i) $3p^2 \times 4p = 12p^3$

(ii) $3p^2 \times -2 = -6p^2$

\therefore Quotient = $4p - 2$

Remainder = $4p$

Ex. (4) $(5x^4 - 3x^3 + 4x^2 + 2x - 6) \div x^2$

Solution :

$$\begin{array}{r} 5x^2 - 3x + 4 \\ x^2 \overline{)5x^4 - 3x^3 + 4x^2 + 2x - 6} \\ \underline{-5x^4} \\ 0 - 3x^3 + 4x^2 + 2x - 6 \\ \underline{+3x^3} \\ 0 + 4x^2 + 2x - 6 \\ \underline{-4x^2} \\ 0 + 2x - 6 \end{array}$$

Explanation -

(i) $x^2 \times 5x^2 = 5x^4$

(ii) $x^2 \times -3x = -3x^3$

(iii) $x^2 \times 4 = 4x^2$

\therefore Quotient = $5x^2 - 3x + 4$

Remainder = $2x - 6$

While dividing a polynomial, the operation of division ends when either the remainder is zero or the degree of the remainder is less than the degree of the divisor polynomial.

Note that, in the above example (3), the degree of remainder $4p$ is less than the degree of the divisor $3p^2$. Similarly in the example (4), the degree of remainder $(2x - 6)$ is less than the degree of the divisor polynomial x^2 .

Practice Set 10.1

1. Divide. Write the quotient and the remainder.

(1) $21m^2 \div 7m$

(2) $40a^3 \div (-10a)$

(3) $(-48p^4) \div (-9p^2)$

(4) $40m^5 \div 30m^3$

(5) $(5x^3 - 3x^2) \div x^2$

(6) $(8p^3 - 4p^2) \div 2p^2$

(7) $(2y^3 + 4y^2 + 3) \div 2y^2$

(8) $(21x^4 - 14x^2 + 7x) \div 7x^3$

(9) $(6x^5 - 4x^4 + 8x^3 + 2x^2) \div 2x^2$

(10) $(25m^4 - 15m^3 + 10m + 8) \div 5m^3$



Let's learn.

To divide a polynomial by a binomial

The method of division of a polynomial by a binomial is the same as the division of a polynomial by a monomial.

Ex. (1) $(x^2 + 4x + 4) \div (x + 2)$

$$\begin{array}{r}
 x + 2 \\
 x + 2 \overline{) x^2 + 4x + 4} \\
 \underline{x^2 + 2x} \\
 0 + 2x + 4 \\
 \underline{+ 2x + 4} \\
 0
 \end{array}$$

Solution :

Explanation

(i) First, write the dividend and divisor in the descending order of their indices. Multiplying the first term of divisor by x , we get first term of the dividend.

\therefore multiply the divisor by x

(ii) $(x + 2) \times \boxed{2} = 2x + 4$

\therefore Quotient = $x + 2$; Remainder = 0

Ex. (2) $(y^4 + 24y - 10y^2) \div (y + 4)$

Solution: In this example, degree of the dividend polynomial is 4. The indices of variable in it are not in descending order. The term with index 3 is missing. Assume it as $0y^3$. Write the dividend in the descending order of indices and then divide.

$$\begin{array}{r}
 y^3 - 4y^2 + 6y \\
 y + 4 \overline{) y^4 + 0y^3 - 10y^2 + 24y} \\
 \underline{-y^4 + 4y^3} \\
 0 - 4y^3 - 10y^2 + 24y \\
 \underline{+ 4y^3 - 16y^2} \\
 0 + 6y^2 + 24y \\
 \underline{- 6y^2 + 24y} \\
 0
 \end{array}$$

Explanation -

- (i) $(y + 4) \times y^3 = y^4 + 4y^3$
- (ii) $(y + 4) \times -4y^2 = -4y^3 - 16y^2$
- (iii) $(y + 4) \times 6y = 6y^2 + 24y$

\therefore Quotient = $y^3 - 4y^2 + 6y$; Remainder = 0

Ex. (3) $(6x^4 + 3x^2 - 9 + 5x + 5x^3) \div (x^2 - 1)$

Solution :

$$\begin{array}{r}
 6x^2 + 5x + 9 \\
 x^2 - 1 \overline{) 6x^4 + 5x^3 + 3x^2 + 5x - 9} \\
 \underline{- 6x^4} \\
 0 + 5x^3 + 9x^2 + 5x - 9 \\
 \underline{+ 5x^3} \\
 0 + 9x^2 + 10x - 9 \\
 \underline{- 9x^2} \\
 0 + 10x + 0
 \end{array}$$

Explanation -

- (i) $(x^2 - 1) \times 6x^2 = 6x^4 - 6x^2$
- (ii) $(x^2 - 1) \times 5x = 5x^3 - 5x$
- (iii) $(x^2 - 1) \times 9 = 9x^2 - 9$

\therefore Quotient = $6x^2 + 5x + 9$; Remainder = $10x$

**Now I know.**

- While dividing a polynomial, the operation of division ends if the remainder is zero or the degree of the remainder is less than the degree of the divisor.
- If terms in the dividend are not in descending order, write them in descending order of indices. If any index term is missing, assume the coefficient of that term to be 0 and then complete the descending order.

Practice Set 10.2

1. Divide and write the quotient and the remainder.

(1) $(y^2 + 10y + 24) \div (y + 4)$

(2) $(p^2 + 7p - 5) \div (p + 3)$

(3) $(3x + 2x^2 + 4x^3) \div (x - 4)$

(4) $(2m^3 + m^2 + m + 9) \div (2m - 1)$

(5) $(3x - 3x^2 - 12 + x^4 + x^3) \div (2 + x^2)$

(6*) $(a^4 - a^3 + a^2 - a + 1) \div (a^3 - 2)$

(7*) $(4x^4 - 5x^3 - 7x + 1) \div (4x - 1)$

**Answers****Practice Set 10.1**

1. $3m, 0$ 2. $-4a^2, 0$ 3. $\frac{16}{3}p^2, 0$ 4. $\frac{4}{3}m^2, 0$

5. $5x - 3, 0$ 6. $4p - 2, 0$ 7. $y + 2, 3$ 8. $3x, -14x^2 + 7x$

9. $3x^3 - 2x^2 + 4x + 1, 0$ 10. $5m - 3, 10m + 8$

Practice Set 10.2

1. $y + 6, 0$ 2. $p + 4, -17$ 3. $4x^2 + 18x + 75, 300$

4. $m^2 + m + 1, 10$ 5. $x^2 + x - 5, x - 2$

6. $a - 1, a^2 + a - 1$ 7. $x^3 - x^2 - \frac{x}{4} - \frac{29}{16}, \frac{-13}{16}$





Let's recall.

Ex. The numbers of pages of a book Ninad read for five consecutive days were 60, 50, 54, 46, 50. Find the average number of pages he read everyday.

Solution :

$$\text{Average} = \frac{\text{Sum of all scores}}{\text{Total number of scores}}$$

$$= \frac{60 + \square + \square + \square + 50}{\square} = \frac{\square}{\square} = \square$$

∴ Average of number of pages read daily is \square

The average is also known as 'Arithmetic mean' or 'Mean'.



Let's learn.

The number of pages read everyday in the above example is numerical data. The conclusion that Ninad read about 50 pages everyday is drawn from the numerical data.

In this way, collecting information regarding certain problem or situation, analysing this information and after interpretation drawing conclusion about it, is a separate branch of knowledge. This branch is known as 'Statistics'.

Arithmetic Mean

We have seen that the average of 60, 50, 54, 46 and 50 is 52. The average is called as '**arithmetic mean**' or simply '**mean**' in statistical language. To find the mean of numerical data, we add all the scores in the data and divide the sum by total number of scores. Let's study some aspects of the method. See the following example.

Ex. The marks obtained by 37 students of std 8 in a test of 10 marks are given below. Find the mean of the data.

2, 4, 4, 8, 6, 7, 3, 8, 9, 10, 10, 8, 9, 7, 6, 5, 4, 6, 7, 8, 4, 8, 9, 7, 6, 5, 10, 9, 7, 9, 10, 9, 6, 9, 9, 4, 7.

Solution: If we go on adding the scores one after the other, it will take lot of time. We know that $7 + 7 + 7 + 7 + 7 = 7 \times 5 = 35$. This simplifies the operation of addition, when a number is to be added to itself. So let us use the method and add the numbers by classifying them.

Marks, x_i Scores	Tally Marks	No. of students frequency f_i	$f_i \times x_i$
2		1	$1 \times 2 = 2$
3		1	$1 \times 3 = 3$
4		5	$5 \times 4 = 20$
5		2	$2 \times 5 = 10$
6		5	$5 \times 6 = 30$
7		6	$6 \times 7 = 42$
8		5	$5 \times 8 = 40$
9		8	$8 \times 9 = 72$
10		4	$4 \times 10 = 40$
		$N = 37$	$\Sigma f_i x_i = 259$

$$\begin{aligned} \text{Mean} &= \frac{\Sigma f_i \times x_i}{N} \\ &= \frac{259}{37} \\ &= 7 \end{aligned}$$

Prepare a table as above and follow the steps to calculate the mean of a data.

- Write the scores in the 1st column, in ascending order as $x_1 < x_2 < x_3 \dots$
- Write the tally marks in next column.
- Count the tally marks of scores and write the frequency of the score, denoted as f_i . Write the sum of all frequencies below the frequency column. The total frequencies is denoted by 'N'.
- In last column write the products $f_i \times x_i$. The sum of $f_i \times x_i$ is denoted as $\Sigma f_i \times x_i$. 'Σ' (sigma) indicates the 'sum'. Arithmetic mean is denoted by \bar{x}

$$\therefore \text{Mean } \bar{x} = \frac{\Sigma f_i \times x_i}{N}$$

Ex. The production of soyabean per acre, in quintal obtained by 30 farmers in Rajapur, is given below.

9, 7.5, 8, 6, 5.5, 7.5, 5, 8, 5, 6.5, 5, 5.5, 4, 4, 8,
6, 8, 7.5, 6, 9, 5.5, 7.5, 8, 5, 6.5, 5, 9, 5.5, 4, 8.

From the given data, prepare a frequency table and find the average production per acre of soyabean.

Solution :

Production per Acre frequency x_i	Tally marks	No of farmers f_i	$f_i \times x_i$
4		3	12
5		5	25
5.5		4	22
6		3	18
6.5		2	13
7.5		4	30
8		6	48
9		3	27
		N = 30	$\Sigma f_i x_i = 195.$

$$\text{Mean } \bar{x} = \frac{\Sigma f_i \times x_i}{N} = \frac{195}{30} = 6.5$$

Hence average production of soyabean per acre is 6.5 quintal.

Practice Set 11.1

1. The following table shows the number of saplings planted by 30 students. Fill in the boxes and find the average number of saplings planted by each student.

No. of saplings (Scores) x_i	No. of students (frequency) f_i	$f_i \times x_i$
1	4	4
2	6	<input type="text"/>
3	12	<input type="text"/>
4	8	<input type="text"/>
	N = <input type="text"/>	$\Sigma f_i x_i =$ <input type="text"/>

$$\text{Mean } \bar{x} = \frac{\text{}}{N}$$

$$= \frac{\text{}}{\text{}}$$

$$= \text{}$$

\therefore The average number of trees planted .

2. The following table shows the electricity (in units) used by 25 families of Eklara village in a month of May. Complete the table and answer the following questions.

Electricity used (Units) x_i	No. of families (frequency) f_i	$f_i \times x_i$
30	7
45	2
60	8
75	5
90	3
	N =	$\Sigma f_i x_i = \dots\dots\dots$

- (1) How many families use 45 units electricity ?
- (2) State the score, the frequency of which is 5.
- (3) Find N, and $\Sigma f_i x_i$
- (4) Find the mean of electricity used by each family in the month of May.

3. The number of members in the 40 families in Bhilar are as follows:
1, 6, 5, 4, 3, 2, 7, 2, 3, 4, 5, 6, 4, 6, 2, 3, 2, 1, 4, 5, 6, 7, 3, 4, 5, 2, 4, 3, 2, 3, 5, 5, 4, 6, 2, 3, 5, 6, 4, 2. Prepare a frequency table and find the mean of members of 40 families.
4. The number of Science and Mathematics projects submitted by Model high school, Nandpur in last 20 years at the state level science exhibition is :
2, 3, 4, 1, 2, 3, 1, 5, 4, 2, 3, 1, 3, 5, 4, 3, 2, 2, 3, 2. Prepare a frequency table and find the mean of the data.

 **Let's learn.**

Last year we have studied simple bar graph and joint bar graph. Now we will study some more bar graphs.

Subdivided bar graph/diagram

As in a joint bar graph, we can compare the information in a data by a subdivided bar diagram also. Here information of two or more constituents is shown by parts of a single bar.

We will see the steps for drawing a subdivided bar graph.

Town	Ithalapur	Dhanodi	Karmabad
Male labourers	180	80	100
Female labourers	120	40	60
Total labourers	300	<input type="text"/>	<input type="text"/>

- First prepare a table of the given data as shown above.

- Draw the X- axis and Y- axis on a graph paper.
- Write the names of towns on X-axis, keeping equal distances between two consecutive bars.
- Show number of labourers on Y - axis with the scale 1cm = 40 labourers.
- Total number of labourers in the town Ithlapur is 300. Show it by a single bar.

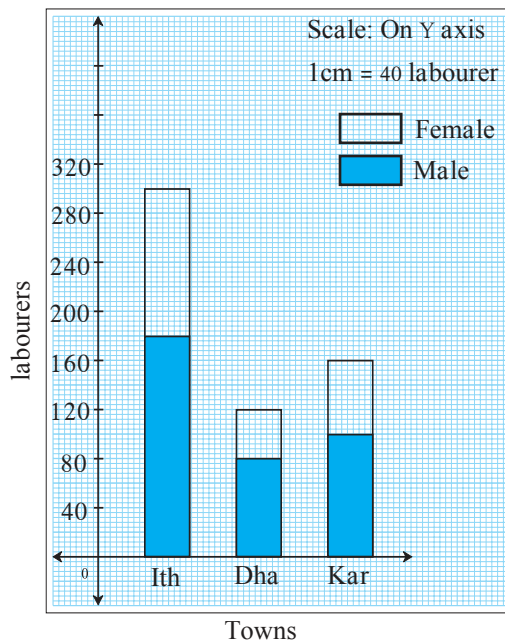

- Show the number of male labourers by a part of the bar by some mark.
- Obviously the remaining part of the bar will represent the female labourers. Show this part by another mark.
- Similarly draw the sub divided bars for the towns Dhanodi and Karmabad.

Following the above steps, the given information is shown by subdivided bar diagram, in the adjacent figure. observe it.

Practice Set 11.2

1. Observe the following graph and answer the questions.

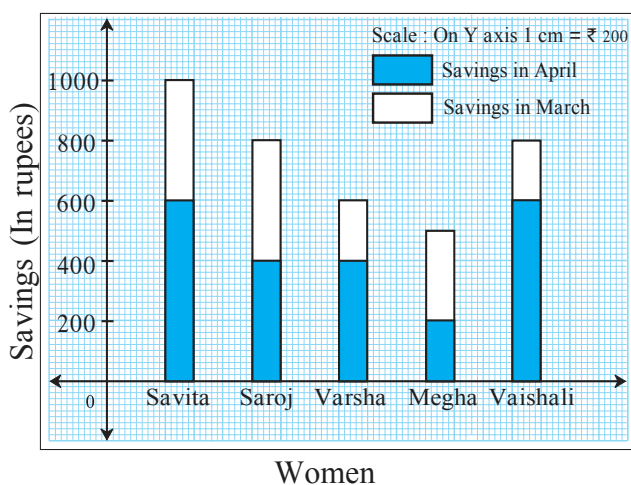

- (1) State the type of the graph.
- (2) How much is the savings of Vaishali in the month of April?
- (3) How much is the total of savings of Saroj in the months March and April?
- (4) How much more is the total savings of Savita than the total savings of Megha?
- (5) Whose savings in the month of April is the least?

2. The number of boys and girls, in std 5 to std 8 in a Z.P. school is given in the table. Draw a subdivided bar graph to show the data.

(Scale : On Y axis, 1cm= 10 students)

Standard	5 th	6 th	7 th	8 th
Boys	34	26	21	25
Girls	17	14	14	20

3. In the following table number of trees planted in the year 2016 and 2017 in four towns is given. Show the data with the help of subdivided bar graph.

town \ year	Karjat	Wadgoan	Shivapur	Khandala
2016	150	250	200	100
2017	200	300	250	150

4. In the following table, data of the transport means used by students in 8th standard for commutation between home and school is given. Draw a subdivided bar diagram to show the data.

(Scale : On Y axis : 1 cm = 500 students)

Town →	Paithan	Yeola	Shahapur
Mean of commutation ↘			
cycle	3250	1500	1250
Bus and Auto	750	500	500
On foot	1000	1000	500



Let's learn.

Percentage bar graph/diagram

In the town Arvi, 42 trees out of 60 trees planted are survived and in the town Morshi 45 trees out of 75 are survived. In the town Barshi 45 trees out of 90 are survived.

To know in which town the plantation is more successful, only numbers of trees planted are not sufficient. For that we have to find percentage of survived plants.

$$\text{In Arvi, the percentage of trees survived} = \frac{42}{60} \times 100 = 70.$$

$$\text{In Morshi, the percentage of trees survived} = \frac{45}{75} \times 100 = 60.$$

From these percentages notice that the percentage of survival of trees in Arvi is more. It means the percentages give somewhat different information. A subdivided bar graph which is drawn by converting the data into percentages is called a percentage bar graph.

That means percentage bar graph is a specific type of subdivided bar graph. We draw the percentage bar graph of the above data using following steps.

- First of all we prepare a table as follows.

Town	Arvi	Morshi	Barshi
Total number of trees	60	75	90
Trees survived	42	45	45
Percentage of survived trees	$\frac{42}{60} \times 100 = 70$	$\frac{45}{75} \times 100 = 60$	$\frac{45}{90} \times 100 = 50$

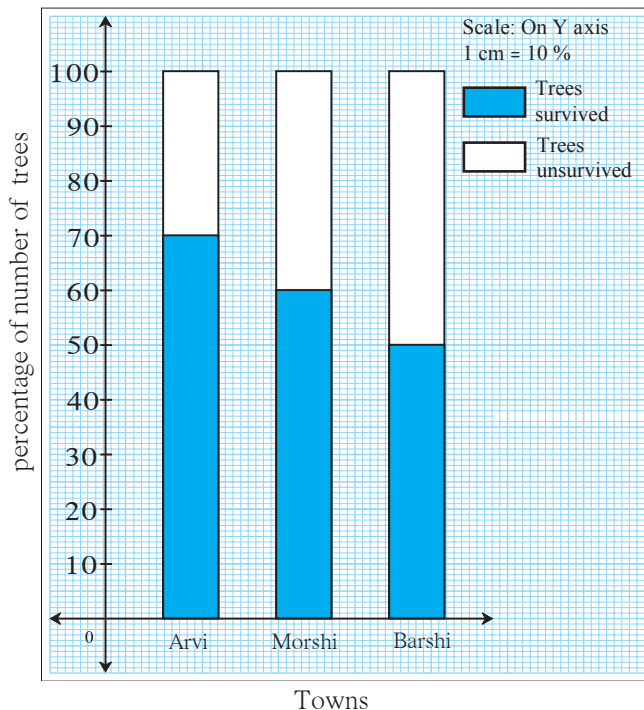

- In a percentage bar graph, all bars are of height 100 units.
- In each bar we show percentage of survived trees. Remaining part shows the percentage of trees which did not survive.
- A percentage bar graph is a specific type of subdivided bar graph, so the remaining procedure of drawing a percentage bar graph is the same as that of a subdivided bar graph.

Practice Set 11.3

1. Show the following information by a percentage bar graph.

Division of standard 8	A	B	C	D
Number of students securing grade A	45	33	10	15
Total number of students	60	55	40	75

2. Observe the following graph and answer the questions.

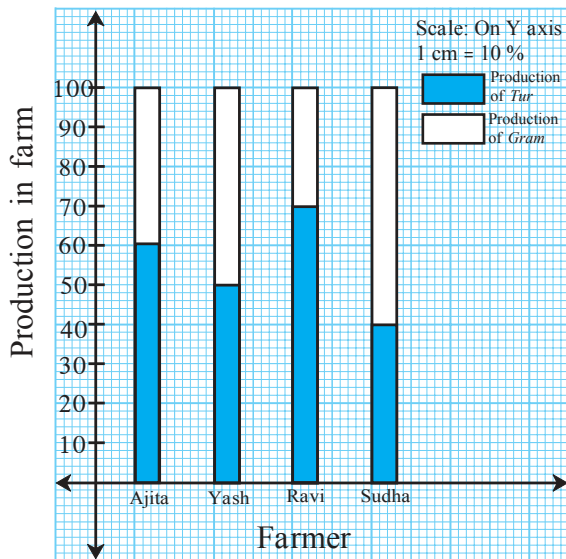

- (1) State the type of the bar graph.
- (2) How much percent is the Tur production to total production in Ajita's farm ?
- (3) Compare the production of Gram in the farms of Yash and Ravi and state whose percentage of production is more and by how much ?
- (4) Whose percentage production of Tur is the least?
- (5) State production percentages of Tur and gram in Sudha's farm.

3. The following data is collected in a survey of some students of 10th standard from some schools. Draw the percentage bar graph of the data.

School	1 st	2 nd	3 rd	4 th
Inclination towards science stream	90	60	25	16
Inclination towards commerce stream	60	20	25	24

Activity : Compare and discuss a percentage bar diagram and a subdivided bar diagram. Use it to learn the graphs in the subjects like Science, Geography.



Answers

Practice Set 11.1 2. (1) 2 (2) 75 (3) $N = 25, \sum f_i \times x_i = 1425$ (4) 57

3. 3.9 4. 2.75

Practice Set 11.2 1. (1) Sub-divided bar graph. (2) ₹ 600 (3) ₹ 800

(4) ₹ 500 (5) Megha's

Practice Set 11.3 2. (1) Percentage bar graph (2) 60%

(3) Yash's, more by 20% (4) Sudha's

(5) 40% and 60%

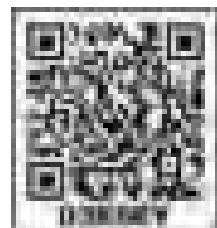

12

Equations in one variable



Let's recall.

In the previous standards we have studied equations in one variable.

- The value of the variable which satisfies the given equation is called the solution of the equation.
- Solving an equation means to find the solution of the equation.
- The equation obtained by performing the same operation on its both sides does not change its solution. Using this property, we obtain new but simpler equations and solve the given equation.

The operations done on both sides of an equation are -

- To add the same number to both sides.
- To subtract the same number from both sides.
- To multiply both sides by the same number.
- To divide both sides by the same non zero number.

Fill in the boxes to solve the following equations.

Ex. (1) $x + 4 = 9$

$$\therefore x + 4 - \square = 9 - \square$$

$$\therefore x = \square$$

Ex. (3) $\frac{x}{3} = 4$

$$\therefore \frac{x}{3} \times \square = 4 \times \square$$

$$\therefore x = \square$$

Ex. (2) $x - 2 = 7$

$$\therefore x - 2 + \square = 7 + \square$$

$$\therefore x = \square$$

Ex. (4) $4x = 24$

$$\therefore \frac{4x}{\square} = \frac{24}{\square}$$

$$\therefore x = \square$$



Let's learn.

Solution of equations in one variable

While solving an equation, sometimes we have to perform many operations on it. We will learn how to find solutions of such equations. Study the following examples.

Ex. (1) Solve the following equations.

(i) $2(x - 3) = \frac{3}{5}(x + 4)$

Solution: Multiplying both sides by 5

$$10(x - 3) = 3(x + 4)$$

$$\therefore 10x - 30 = 3x + 12$$

Adding 30 to both sides

$$\therefore 10x - 30 + 30 = 3x + 12 + 30$$

$$10x = 3x + 42$$

Subtracting $3x$ from both sides

$$\therefore 10x - 3x = 3x + 42 - 3x$$

$$\therefore 7x = 42$$

Dividing both sides by 7

$$\frac{7x}{7} = \frac{42}{7}$$

$$\therefore x = 6$$

(iii) $\frac{2}{3} + 5a = 4$

Solution: Method I

$$\frac{2}{3} + 5a = 4$$

Multiplying each term by 3

$$3 \times \frac{2}{3} + 3 \times 5a = 4 \times 3$$

$$\therefore 2 + 15a = 12$$

$$\therefore 15a = 12 - 2$$

$$\therefore 15a = 10$$

$$\therefore a = \frac{10}{15}$$

$$\therefore a = \frac{2}{3}$$

(ii) $9x - 4 = 6x + 29$

Solution: Adding 4 to both sides

$$9x - 4 + 4 = 6x + 29 + 4$$

$$\therefore 9x = 6x + 33$$

Subtracting $6x$ from both sides

$$\therefore 9x - 6x = 6x + 33 - 6x$$

$$\therefore 3x = 33$$

Dividing both sides by 3

$$\therefore \frac{3x}{3} = \frac{33}{3}$$

$$\therefore x = 11$$

Method II

Subtracting $\frac{2}{3}$ from both the sides,

$$\frac{2}{3} + 5a - \frac{2}{3} = 4 - \frac{2}{3}$$

$$\therefore 5a = \frac{12-2}{3}$$

$$\therefore 5a = \frac{10}{3}$$

Dividing both sides by 5

$$\frac{5a}{5} = \frac{10}{3} \times \frac{1}{5}$$

$$\therefore a = \frac{2}{3}$$

If A, B, C, D are nonzero expressions such that $\frac{A}{B} = \frac{C}{D}$ then multiplying both sides by $B \times D$ we get the equation $AD = BC$. Using this we will solve examples.

$$(iv) \quad \frac{(x-7)}{(x-2)} = \frac{5}{4}$$

Solution: $\frac{(x-7)}{(x-2)} = \frac{5}{4}$

$$\therefore 4(x-7) = 5(x-2)$$

$$\therefore 4x - 28 = 5x - 10$$

$$\therefore 4x - 5x = -10 + 28$$

$$\therefore -x = 18 \quad \therefore x = -18$$

$$(v) \quad \frac{8m-1}{2m+3} = 2$$

Solution: $\frac{8m-1}{2m+3} = \frac{2}{1}$

$$1(8m-1) = 2(2m+3)$$

$$\therefore 8m - 1 = 4m + 6$$

$$\therefore 8m - 4m = 6 + 1$$

$$\therefore 4m = 7 \quad \therefore m = \frac{7}{4}$$

Practice Set 12.1

1. Each equation is followed by the values of the variable. Decide whether these values are the solutions of that equation.

(1) $x - 4 = 3$, $x = -1, 7, -7$

(2) $9m = 81$, $m = 3, 9, -3$

(3) $2a + 4 = 0$, $a = 2, -2, 1$

(4) $3 - y = 4$, $y = -1, 1, 2$

2. Solve the following equations.

(1) $17p - 2 = 49$

(2) $2m + 7 = 9$

(3) $3x + 12 = 2x - 4$

(4) $5(x - 3) = 3(x + 2)$

(5) $\frac{9x}{8} + 1 = 10$

(6) $\frac{y}{7} + \frac{y-4}{3} = 2$

(7) $13x - 5 = \frac{3}{2}$

(8) $3(y + 8) = 10(y - 4) + 8$

(9) $\frac{x-9}{x-5} = \frac{5}{7}$

(10) $\frac{y-4}{3} + 3y = 4$

(11) $\frac{b+(b+1)+(b+2)}{4} = 21$



Let's learn.

Word Problems

Let's learn how the information given in the word problem can be converted into an algebraic expression using variable.

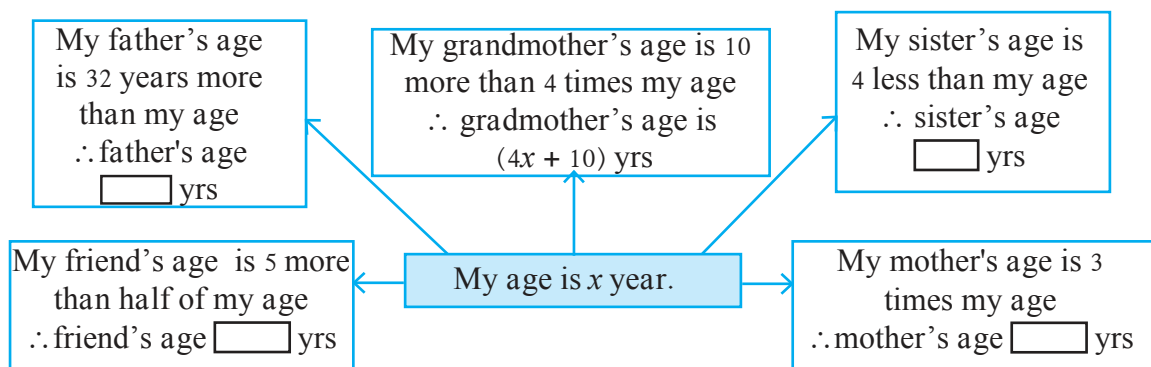

From the above information find my age if my friend's age is 12 years.

$$\text{My age} = x \text{ years} \quad \therefore \text{friend's age} = \frac{x}{2} + 5$$

$$\frac{x}{2} + 5 = 12 \quad \dots\dots \text{(Given)}$$

$$\therefore x + 10 = 24 \quad \dots\dots \text{(Multiplying each term by 2)}$$

$$\therefore x = 24 - 10$$

$$\therefore x = 14,$$

\therefore My age is 14 years.

Find the ages of other persons from the above information.

Activity : Write correct numbers in the boxes given.

length is 3 times the breadth

I am a rectangle.
My perimeter is
40 cm.

breadth
 x

Perimeter of the rectangle = 40

$$2(\square x + \square x) = 40$$

$$2 \times \square x = 40$$

$$\square x = 40$$

$$x = \square$$

\therefore Breadth of rectangle = \square cm and Length of rectangle = \square cm

Solved Examples

Ex. (1) Joseph's weight is two times the weight of his younger brother. Find Joseph's weight if sum of their weights is 63 kg

Solution: Let the weight of Joseph's younger brother be x kg

\therefore Joseph's weight is two times the weight of his younger brother = $2x$

\therefore from the given information $x + 2x = 63$

$$\therefore 3x = 63 \quad \therefore x = 21$$

\therefore Joseph's weight = $2x = 2 \times 21 = 42$ kg

Ex. (2) Numerator of a fraction is 5 more than its denominator. If 4 is added to numerator and denominator, the fraction obtained is $\frac{6}{5}$. Find the fraction.

Solution: Let the demonator of the fraction be x .

\therefore Numerator of the fraction is 5 more than denominator means $x + 5$.

\therefore The fraction is $\frac{x+5}{x}$.

If 4 is added to both numerator and denominator, fraction obtained is $\frac{6}{5}$

$$\therefore \frac{x+5+4}{x+4} = \frac{6}{5}$$

$$\therefore \frac{x+9}{x+4} = \frac{6}{5}$$

$$\therefore 5(x+9) = 6(x+4)$$

$$\therefore 5x + 45 = 6x + 24$$

$$\therefore 45 - 24 = 6x - 5x$$

$$\therefore 21 = x$$

\therefore denominator of fraction = 21,
and numerator = $21 + 5 = 26$

$$\therefore \text{the fraction is} = \frac{26}{21}$$

Ex. (3) Ratna has ₹200 more than three times the amount Rafik has. If ₹ 300 from the amount with Ratna are given to Rafik, amount with Ratna will be $\frac{7}{4}$ times the amount with Rafik. Find the initial amount with Rafik.

To find the initial amount, complete the following activity.

Solution: The amount with Ratna is ₹ 200 more than three times the amount with Rafik.

Let the initial amount with Rafik be ₹ x \therefore Ratna has ₹

\therefore ₹ 300 from Ratna are given to Rafik.

\therefore Remaining amount with Ratna is .

\therefore Now Rafik has ₹ $(x + 300)$

Now the amount with Ratna is $\frac{7}{4}$ times the amount with Rafik

$$\therefore \frac{\text{Amount with Ratna}}{\text{Amount with Rafik}} = \frac{\text{input}}{\text{input}}$$

$$\therefore \frac{3x-100}{x+300} = \frac{\text{input}}{\text{input}}$$

$$\therefore 4 \text{ input} = 7 \text{ input}$$

$$\therefore 12x - 400 = 7x + 2100$$

$$\therefore 12x - 7x = \text{input}$$

$$\therefore 5x = \text{input}$$

$$\therefore x = \text{input}$$

\therefore Rafik initially has ₹ with him.

Practice Set 12.2

- Mother is 25 year older than her son. Find son's age if after 8 years ratio of son's age to mother's age will be $\frac{4}{9}$.
- The denominator of a fraction is greater than its numerator by 12. If the numerator is decreased by 2 and the denominator is increased by 7, the new fraction is equivalent with $\frac{1}{2}$. Find the fraction.

3. The ratio of weights of copper and zinc in brass is 13:7. Find the weight of zinc in a brass utensil weighing 700 gm.
- 4*. Find three consecutive whole numbers whose sum is more than 45 but less than 54.
5. In a two digit number, digit at the ten's place is twice the digit at units' place. If the number obtained by interchanging the digits is added to the original number, the sum is 66. Find the number.
- 6*. Some tickets of ₹ 200 and some of ₹ 100, of a drama in a theatre were sold. The number of tickets of ₹ 200 sold was 20 more than the number of tickets of ₹ 100. The total amount received by the theatre by sale of tickets was ₹ 37000. Find the number of ₹ 100 tickets sold.
7. Of the three consecutive natural numbers, five times the smallest number is 9 more than four times the greatest number, find the numbers.
8. Raju sold a bicycle to Amit at 8% profit. Amit repaired it spending ₹ 54. Then he sold the bicycle to Nikhil for ₹ 1134 with no loss and no profit. Find the cost price of the bicycle for which Raju purchased it.
9. A Cricket player scored 180 runs in the first match and 257 runs in the second match. Find the number of runs he should score in the third match so that the average of runs in the three matches be 230.
10. Sudhir's present age is 5 more than three times the age of Viru. Anil's age is half the age of Sudhir. If the ratio of the sum of Sudhir's and Viru's age to three times Anil's age is 5:6, then find Viru's age.



Answers

Practice Set 12.1 1. Values which are solutions. (1) $x = 7$ (2) $m = 9$ (3) $a = -2$

(4) $y = -1$ 2. (1) $p = 3$ (2) $m = 1$ (3) $x = -16$ (4) $x = \frac{21}{2}$ (5) $x = 8$ (6) $y = 7$

(7) $x = \frac{1}{2}$ (8) $y = 8$ (9) $x = 19$ (10) $y = \frac{8}{5}$ (11) $b = 27$

Practice Set 12.2 1. 12 years 2. $\frac{23}{35}$ 3. 245 gm

4. 15, 16, 17 or 16, 17, 18 5. 42 6. 110

7. 17, 18, 19 8. ₹ 1000 9. 253 10. 5 years

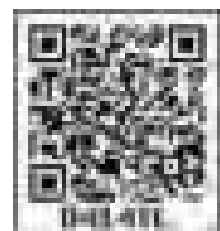



Let's recall.

Write answers to the following questions referring to the adjacent figure.

- Which is the angle opposite to the side DE?
- Which is the side opposite to $\angle E$?
- Which angle is included by side DE and side DF?
- Which side is included by $\angle E$ and $\angle F$?
- State the angles adjacent to side DE.

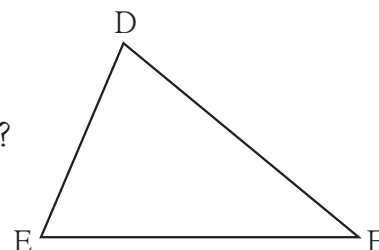

- The figures which exactly coincide with each other are called congruent figures.
- The segments of equal lengths are congruent.
- The angles of equal measures are congruent.



Let's learn.

Congruence of triangles

Activity : Observe the adjacent figures. Copy $\triangle ABC$ on a tracing paper. Place it on $\triangle PQR$ such that point A coincides with point P, point B with point Q and point C with point R. You will find that both the triangles coincide exactly with each other, that is they are congruent.

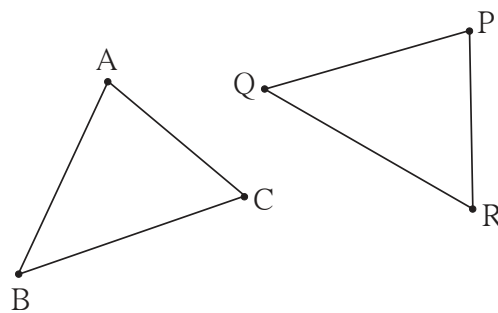

In the activity, one way of placing $\triangle ABC$ on $\triangle PQR$ is given. But if we place point A on point Q, point B on point R and point C on point P, then two triangles will not coincide with each other. It means, the vertices must be matched in a specific way. The way of matching the vertices is denoted by one-to-one correspondence. Point A corresponds to point P is denoted as $A \leftrightarrow P$. Here, two triangles are congruent in the correspondence $A \leftrightarrow P$, $B \leftrightarrow Q$, $C \leftrightarrow R$. When the two triangles are congruent in this way, we get six congruences, namely $\angle A \cong \angle P$, $\angle B \cong \angle Q$, $\angle C \cong \angle R$, $\text{seg } AB \cong \text{seg } PQ$, $\text{seg } BC \cong \text{seg } QR$,

seg $CA \cong$ seg RP . Therefore, it is said that, $\triangle ABC$ and $\triangle PQR$ are congruent in the correspondence $ABC \leftrightarrow PQR$ and written as $\triangle ABC \cong \triangle PQR$.

$\triangle ABC \cong \triangle PQR$ implies the correspondence $A \leftrightarrow P, B \leftrightarrow Q, C \leftrightarrow R$ and the six congruences mentioned above. Therefore, while writing the congruence of two triangles, we have to take care that the order of vertices observes the one to one correspondence ascertaining congruence.



$\triangle ABC$ and $\triangle PQR$ are congruent. Their congruent parts are indicated by the identical marks.

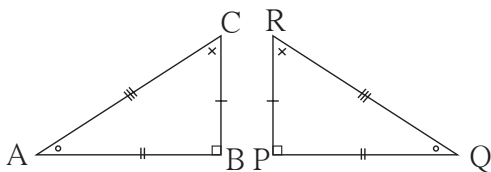

- Anil : $\triangle ABC \cong \triangle QPR$
 Rehana : $\triangle BAC \cong \triangle PQR$
 Surjit : $\triangle ABC \cong \triangle PQR$

Anil, Rehana and Surjit had written congruence of the triangles as follows.

Which of the statements is correct and which is wrong ?
 Discuss.

Solved Example

Ex. (1) In the adjacent figure, parts of triangles indicated by identical marks are congruent (i) Identify the one to one correspondence of vertices in which the two triangles are congruent and write the congruence in two ways.

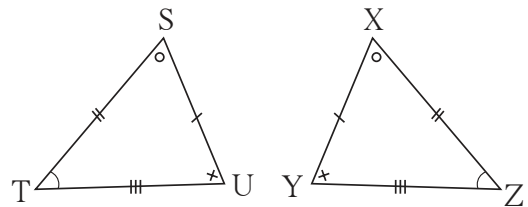

(ii) State with reason, whether the statement, $\triangle XYZ \cong \triangle STU$ is right or wrong.

Solution: By observation, the triangles are congruent in the correspondence $STU \leftrightarrow XZY$ hence

(i) $\triangle STU \cong \triangle XZY$ is one way; $\triangle UST \cong \triangle YXZ$ is another way.

Write the same congruence in some more different ways.

(ii) If the congruence is written as $\triangle XYZ \cong \triangle STU$, it will mean side $ST \cong$ side XY , which is wrong.

\therefore statement $\triangle XYZ \cong \triangle STU$ is wrong.

(The writing $\triangle XYZ \cong \triangle STU$ includes some more mistakes. Students should find them out. Note that, to show that an answer is wrong it is sufficient to point out one mistake.)

Ex. (2) In the given figure, the identical marks show the congruent parts in the pair of triangles. State the correspondence between the vertices of the triangles in which the two triangles are congruent.

Solution : In $\triangle ABD$ and $\triangle ACD$, side AD is common. Every segment is congruent to itself. Therefore,

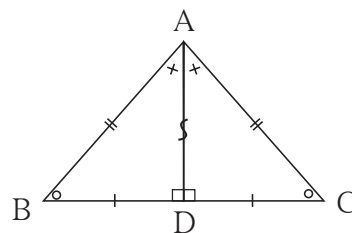

Correspondence: $A \leftrightarrow A, B \leftrightarrow C, D \leftrightarrow D. \triangle ABD \cong \triangle ACD$

Note: It is a convention to indicate a common side by the symbol ‘ $\}$ ’



To show that a pair of triangles is congruent, it is not necessary to show that all six corresponding parts of the two triangles are congruent. If three specific parts of one triangle are respectively congruent with the three corresponding parts of the other, then the remaining three corresponding parts are also congruent with each other. It means, the specific three parts ascertain the test of congruence.

We have learnt to construct triangles. The three specific parts of a triangle which define a unique triangle decide a test of congruence. Let us verify this.

(1) Two sides and the included angle : SAS Test

Draw $\triangle ABC$ and $\triangle LMN$ such that two pairs of their sides and the angles included by them are congruent.

Draw $\triangle ABC$ and $\triangle LMN$, $l(AB) = l(LM)$, $l(BC) = l(MN)$, $m\angle ABC = m\angle LMN$

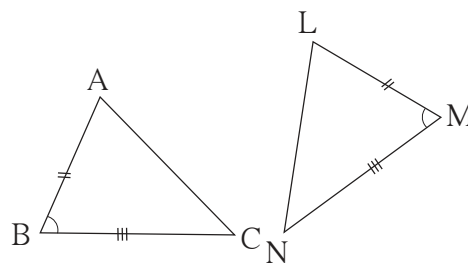

Copy $\triangle ABC$ on a tracing paper. Place the paper on $\triangle LMN$ in such a way that point A coincides with point L , side AB overlaps side LM , $\angle B$ overlaps $\angle M$ and side BC overlaps side MN . You will notice that $\triangle ABC \cong \triangle LMN$.

(2) Three corresponding sides: SSS test

Draw $\triangle PQR$ and $\triangle XYZ$ such that $l(PQ) = l(XY)$, $l(QR) = l(YZ)$, $l(RP) = l(ZX)$.

Copy $\triangle PQR$ on a tracing paper. Place it on $\triangle XYZ$ observing the correspondence $P \leftrightarrow X$, $Q \leftrightarrow Y$, $R \leftrightarrow Z$. You will notice that $\triangle PQR \cong \triangle XYZ$.

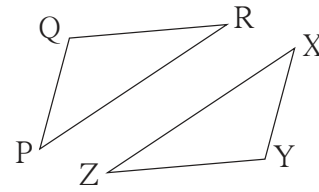

(3) Two angles and their included side: ASA test

Draw $\triangle XYZ$ and $\triangle DEF$ such that, $l(XZ) = l(DF)$, $\angle X \cong \angle D$ and $\angle Z \cong \angle F$.

Copy $\triangle XYZ$ on a tracing paper and place it over $\triangle DEF$. Note that $\triangle XYZ \cong \triangle DEF$ in the correspondence $X \leftrightarrow D$, $Y \leftrightarrow E$, $Z \leftrightarrow F$.

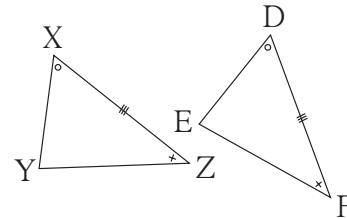

(4) AAS (or SAA) test :

The sum of the measures of angles in a triangle is 180° . Therefore, if two corresponding pairs of angles in two triangles are congruent, then the remaining pair of angles is also congruent. Hence, if two angles and a side adjacent to one of them are congruent with corresponding parts of the other triangle then the condition for ASA test is fulfilled. So the triangles are congruent.

(5) Hypotenuse side test for right angled triangles : (Hypotenuse-side test)

There is a unique right angled triangle of a given side and hypotenuse. Draw two right angled triangles such that a side and the hypotenuse of one is congruent with the corresponding parts of the other. Verify that they are congruent by the method given above.

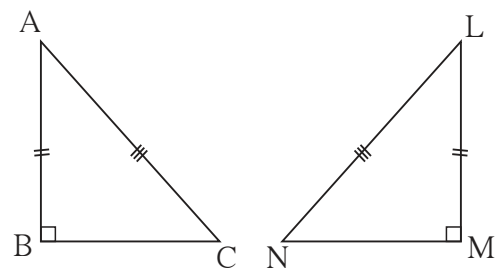

Solved Examples

Ex. (1) In the given figures parts of triangles bearing identical marks are congruent. State the test and the one to one correspondence of vertices by which the triangles in each pair are congruent.

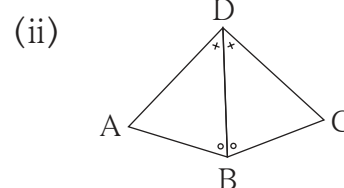
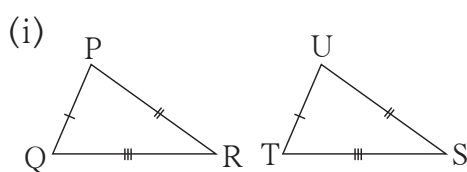

- Solution:**(i) By SSS test, in the correspondence $PQR \leftrightarrow UTS$
(ii) By ASA test, in the correspondence $DBA \leftrightarrow DBC$

Ex. (2) In each pair of triangles in the following figures, parts indicated by identical marks are congruent. A test of congruence of triangles is given below each figure. State the additional information which is necessary to show that the triangles are congruent by the given test. With this additional information, state the one to one correspondence in which the triangles will be congruent.

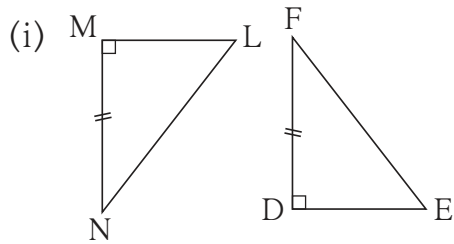

Hypotenuse - side test

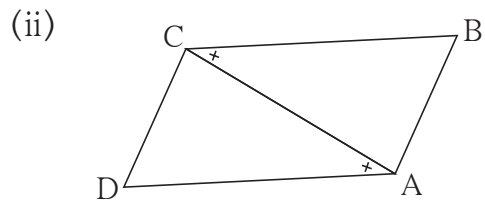

ASA test

Solution:(i) The given triangles are right angled. One of the sides of a triangle is congruent with a side of the other triangle. So the additional information necessary is hypotenuse $LN \cong$ hypotenuse FE . With this information the triangles will be congruent in the correspondence $LMN \leftrightarrow EDF$.

(ii) The side CA of the two triangles is common. So the additional necessary information is $\angle DCA \cong \angle BAC$. With this information, the triangles will be congruent in the correspondence $DCA \leftrightarrow BAC$.

Practice Set 13.1

1. In each pair of triangles in the following figures, parts bearing identical marks are congruent. State the test and correspondence of vertices by which triangles in each pair are congruent .

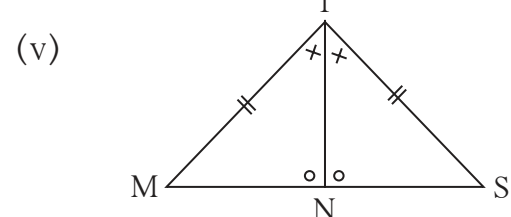
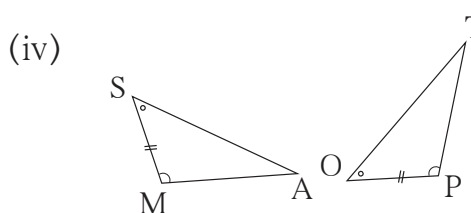
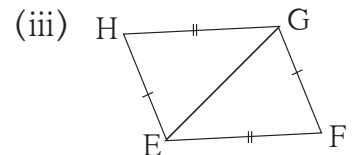
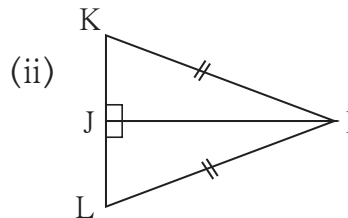
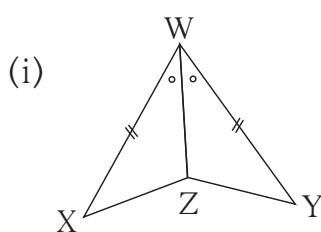

 **Now I know.**

- (1) **S-A-S test** : If two sides and the included angle of a triangle are congruent with two corresponding sides and the included angle of the other triangle then the triangles are congruent with each other.
- (2) **S-S-S test** : If three sides of a triangle are congruent with three corresponding sides of the other triangle, then the two triangles are congruent.
- (3) **A-S-A test** : If two angles of a triangle and a side included by them are congruent with two corresponding angles and the side included by them of the other triangle, then the triangles are congruent with each other.
- (4) **A-A-S test** : If two angles of a triangle and a side not included by them are congruent with corresponding angles and a corresponding side not included by them of the other triangle then the triangles are congruent with each other.
- (5) **Hypotenuse - side test** : If the hypotenuse and a side of a right angled triangle are congruent with the hypotenuse and the corresponding side of the other right angled triangle, then the two triangles are congruent with each other.

For more information

If two sides and an angle not included by them are congruent with corresponding parts of the other triangle, will the two triangles be congruent ?

See the adjoining figure. In $\triangle ABC$ and $\triangle ABD$, side AB is common, side $BC \cong$ side BD $\angle A$ is common, but it is not included by those sides. That is, three parts of a triangle are congruent with three corresponding parts of the other, but the two triangles are not congruent.

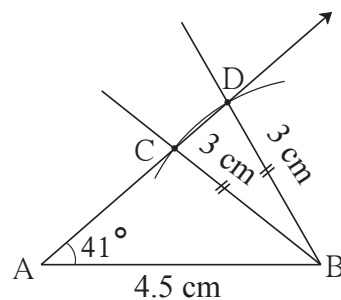

Therefore, if two sides and an angle not included by them are congruent with corresponding parts of the other, then the two triangles are not necessarily congruent.

Solved Example

Ex. (1) In the adjacent figure, congruent sides of \square ABCD are shown by identical marks. State if there are any pairs of congruent angles in the figure.

Solution: In $\triangle ABD$ and $\triangle CBD$,

side $AB \cong$ side CB (given)

side $DA \cong$ side DC (given)

side BD is common

$\therefore \triangle ABD \cong \triangle CBD$ (S-S-S test)

$\therefore \angle ABD \cong \angle CBD$

$\angle ADB \cong \angle CDB$

$\angle BAD \cong \angle BCD$

}(corresponding angles of congruent triangles)

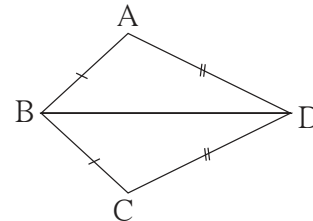

Practice Set 13.2

1. In each pair of triangles given below, parts shown by identical marks are congruent. State the test and the one to one correspondence of vertices by which triangles in each pair are congruent and remaining congruent parts.

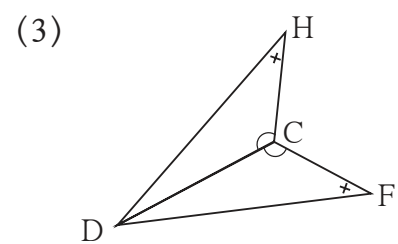
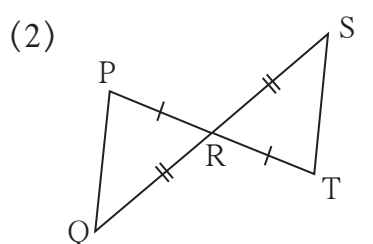
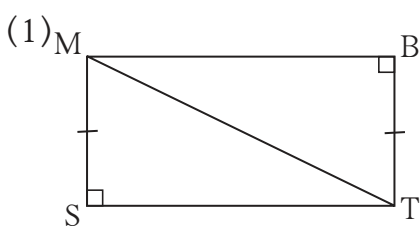

2*. In the adjacent figure, $seg AD \cong seg EC$. Which additional information is needed to show that $\triangle ABD$ and $\triangle ECB$ will be congruent by A-A-S test ?

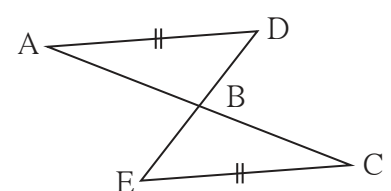

Answers

Practice Set 13.1 1. (i) SAS, $XWZ \leftrightarrow YWZ$ (ii) Hypotenuse - side test, $KJI \leftrightarrow LJI$
 (iii) SSS, $HEG \leftrightarrow FGE$ (iv) ASA, $SMA \leftrightarrow OPT$ (v) ASA or SAA, $MTN \leftrightarrow STN$

Practice Set 13.2

1. (1) $\triangle MST \cong \triangle TBM$ - Hypotenuse - side, side $ST \cong$ side MB ,
 $\angle SMT \cong \angle BTM$, $\angle STM \cong \angle BMT$ (2) $\triangle PRQ \cong \triangle TRS$ - SAS,
 side $PQ \cong$ side TS , $\angle RPQ \cong \angle RTS$, $\angle PQR \cong \angle TSR$
 (3) $\triangle DCH \cong \triangle DCF$ - SAA, $\angle DHC \cong \angle DFC$, side $HC \cong$ side FC
 2. $\angle ADB \cong \angle CEB$ and $\angle ABD \cong \angle CBE$;
 or $\angle DAB \cong \angle ECB$ and $\angle ABD \cong \angle CBE$

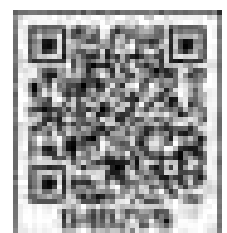

14

Compound interest



Let's recall.

A person takes a loan from institutes like bank or *patapedhi* with fixed rate of interest. After stipulated time he repays the loan with some more money. The additional money paid is called interest.

We have learnt the formula for finding the interest, $I = \frac{PNR}{100}$.

In this formula I = Interest, P = Principal, N = Number of years and R = Rate of interest at p.c.p.a. This is how the simple interest is calculated.



Let's learn.

Compound Interest

We will learn how bank charges compound interest for a fixed deposit or a loan.

Teacher : Sajjanrao takes a loan of ₹10,000 from a bank at the rate of 10 p.c.p.a. for 1 year. How much money including the interest he will have to pay after one year?

Student : Here P = ₹10,000 ; R = 10; N = 1 year

$$\therefore I = \frac{PNR}{100} = \frac{10000 \times 10 \times 1}{100} = ₹ 1000$$

\therefore After one year Sajjanrao will have to pay 10,000 + 1000 = ₹ 11,000 with interest.

Student : If a borrower fails to pay the amount and interest after one year?

Teacher : Bank calculates the interest after each year and it is expected that the interest should be paid by the borrower every year. If the borrower fails to pay the interest for one year then the bank considers the principal and the interest of first year together as the loan for second year. Thus for second year, the interest is calculated on the amount formed by principal of first year together with its interest. That is for second year the principal for charging interest is the amount of the first year. The interest charged by this method is called as compound interest.

Student : If Sajjanrao increases the duration of loan repayment by one more year?

Teacher : Then for second year considering ₹ 11,000 as principal, interest and amount is to be found out.

Student : For this can we use the ratio $\frac{\text{Amount}}{\text{Principal}} = \frac{110}{100}$ which is learnt in the previous standard?

Teacher : Surely ! For every year the ratio $\frac{\text{Amount}}{\text{Principal}}$ is constant. While finding compound interest every year, the amount (A) of previous year is the principal for next year. Hence it is convenient to find amount rather than the interest. Let us write the amount after first year as A_1 , after second year A_2 and after third year as A_3 .

Originally the principal is P.

$$\therefore \frac{A_1}{P} = \frac{110}{100} \therefore A_1 = P \times \frac{110}{100}$$

For finding the amount A_2 of second year,

$$\frac{A_2}{A_1} = \frac{110}{100} \therefore A_2 = A_1 \times \frac{110}{100} = P \times \frac{110}{100} \times \frac{110}{100}$$

Student: Then for finding the amount A_3 of third year,

$$\frac{A_3}{A_2} = \frac{110}{100} \therefore A_3 = A_2 \times \frac{110}{100} = P \times \frac{110}{100} \times \frac{110}{100} \times \frac{110}{100}$$

Teacher : Very Good ! This is the formula for finding the amount by compound interest. Here $\frac{110}{100}$ is the amount of ₹1 after one year. To find amount after the given number of years multiply the principal by those many times by this ratio.

Student : If the ratio $\frac{\text{Amount}}{\text{Principal}}$ is assumed to be M then the amount after one year is $P \times M$, after second year is $P \times M^2$, after third year PM^3 . In this way we can find the amount after any number of years.

Teacher : Correct ! If the interest rate is R p.c.p.a. then,

$$\text{the amount of ₹1 after 1 year} = 1 \times M = 1 \times \frac{100+R}{100} = 1 \times \left(1 + \frac{R}{100}\right)$$

$$\text{the amount of ₹ P after 1 year} = P \times \frac{100+R}{100} = P \times \left(1 + \frac{R}{100}\right)$$

\therefore if the principal P, interest rate R p.c.p.a. and duration is N years then the amount after N years, $A = P \times \left(\frac{100+R}{100}\right)^N = P \times \left(1 + \frac{R}{100}\right)^N$

Solved Example

Ex. (1) Find the compound interest if ₹4000 are invested for 3 years at the rate of $12\frac{1}{2}$ p.c.p.a.

Solution: Here, $P = ₹ 4000$; $R = 12\frac{1}{2}\%$; $N = 3$ years.

$$A = P \left(1 + \frac{R}{100}\right)^N = P \left(1 + \frac{12.5}{100}\right)^3$$

$$= 4000 \left(1 + \frac{12.5}{100}\right)^3$$

$$A = 4000 \left(\frac{1125}{1000}\right)^3 = 4000 \left(\frac{9}{8}\right)^3$$

$$= 5695.31 \text{ Rupees}$$

∴ Compound Interest after three years, I = Amount - Principal
 = 5695.31 - 4000 = 1695.31 rupees

Practice Set 14.1

1. Find the amount and the compound interest.

No.	Principal (₹)	Rate (p.c.p.a.)	Duration (years)
1	2000	5	2
2	5000	8	3
3	4000	7.5	2

2. Sameerrao has taken a loan of ₹12500 at a rate of 12 p.c.p.a. for 3 years. If the interest is compounded annually then how many rupees should he pay to clear his loan?
3. To start a business Shalaka has taken a loan of ₹8000 at a rate of $10\frac{1}{2}$ p.c.p.a. After two years how much compound interest will she have to pay ?

For more information

- Some times the interest is calculated at an interval of six months. For the duration of N years, if rate is R and if the interest to be calculated six monthly then the rate is to be taken as $\frac{R}{2}$ and the duration is considered as 2N stages of six months.
- Many banks charge the compound interest monthly. At that time they take the interest rate as $\frac{R}{12}$ monthly and the duration is taken $12 \times N$ stages of months and interest is calculated.
- Now a days banks calculate compound interest daily.

Activity: Visit the bank nearer to your house and get the information regarding the different schemes and rate of interests. Make a chart and display in your class.



Let's learn.

Application of formula for compound interest

The formula for amount by compound interest is very useful to solve the problems in other fields related to our practical life; for example increase in the population, the reduction in the value of vehicle or machine etc. If any article is sold after using it for some time its value reduces as compared to its cost price. This reduction in price is called 'depreciation'.

The depreciation takes place by a specific rate for a specific time. For example every year price of a machine reduces by a definite percentage. For finding the reduced price over a period of time the formula for compound interest is used. To find the reduced price, rate of depreciation should be known. In such a case the value of the article decreases, so the rate of depreciation R is taken as negative.

Ex. (1) The population of a city increases at compounding rate of 8% per year. Find the population in the year 2012 if population in the year 2010 was 2,50,000.

Solution: $P =$ Population in the year 2010 = 2,50,000

$A =$ Population in the year 2012;

$R =$ Rate of increase of population per year = 8%

$N = 2$ years

$A =$ Population in the year 2012, that is population after 2 years

$$\begin{aligned} A &= P \times \left(1 + \frac{R}{100}\right)^N = 250000 \times \left(1 + \frac{8}{100}\right)^2 \\ &= 250000 \times \left(\frac{108}{100}\right)^2 \\ &= 250000 \times \left(\frac{108}{100}\right) \times \left(\frac{108}{100}\right) \\ &= 2,91,600. \end{aligned}$$

\therefore In the year 2012, population of the city was 2,91,600.

Ex. (2) Rehana purchased a scooter in the year 2015 for ₹60000. If its value falls by 20% every year what will be the price of scooter after 2 years ?

Solution: $P = ₹60000$ $A =$ Amount obtained after two years

$R =$ Rate of depreciation = 20 % $N = 2$ years

$A =$ Amount obtained after 2 years

$$\begin{array}{l}
 A = P \times \left(1 + \frac{R}{100}\right)^N \\
 = 60000 \times \left(1 - \frac{1}{5}\right)^2 \\
 = 60000 \times \frac{4}{5} \times \frac{4}{5}
 \end{array}
 \quad \text{---} \quad
 \begin{array}{l}
 A = 60000 \times \left(1 + \frac{-20}{100}\right)^2 \\
 = 60000 \times \left(\frac{4}{5}\right)^2 \\
 A = 38400 \text{ rupees.}
 \end{array}$$

∴ After two years the price will be Rs. 38400.

In the formula for compound interest four quantities A, P, N and R incur. If three of them are given, study how the fourth can be found out from the following examples.

Ex. (3) The amount of a certain principal is ₹6655 in 3 years, compounded annually at the rate of 10 p.c.p.a. Find the principal.

Solution: $A = ₹6655$; $R = 10$ p.c.p.a ; $N = 3$ years

$$\begin{array}{l}
 A = P \times \left(1 + \frac{R}{100}\right)^N \\
 \therefore 6655 = P \times \left(1 + \frac{10}{100}\right)^3 = P \times \left(\frac{110}{100}\right)^3 \\
 \therefore P = \frac{6655 \times 10^3}{11 \times 11 \times 11} \qquad P = 5 \times 10^3 \qquad = 5000
 \end{array}$$

∴ the principal was ₹ 5000.

Ex. (4) Find the number of years for which the compound interest of ₹9000 is ₹1890, at the rate of 10 p.c.p.a. .

Solution: $R = 10\%$; $P = ₹ 9000$; compound interest = ₹ 1890

We will find the amount first.

$$A = P + I = 9000 + 1890 = ₹ 10890$$

Write the formula for compound interest and substitute the values.

$$A = 10890 = P \times \left(1 + \frac{R}{100}\right)^N = 9000 \times \left(1 + \frac{10}{100}\right)^N = 9000 \times \left(\frac{11}{10}\right)^N$$

$$\therefore \left(\frac{11}{10}\right)^N = \frac{10890}{9000} = \frac{121}{100} \quad \therefore \left(\frac{11}{10}\right)^N = \frac{121}{100} \quad \therefore N = 2$$

\therefore compound interest is for 2 years.

Practice Set 14.2

- On the construction work of a flyover bridge there were 320 workers initially. The number of workers were increased by 25% every year. Find the number of workers after 2 years.
- A shepherd has 200 sheep with him. Find the number of sheep with him after 3 years if the increase in number of sheep is 8% every year.
- In a forest there are 40,000 trees. Find the expected number of trees after 3 years if the objective is to increase the number at the rate 5% per year.
- The cost price of a machine is 2,50,000. If the rate of depreciation is 10% per year find the depreciation in price of the machine after two years.
- Find the compound interest if the amount of a certain principal after two years is ₹4036.80 at the rate of 16 p.c.p.a.
- A loan of ₹15000 was taken on compound interest. If the rate of compound interest is 12 p.c.p.a. find the amount to settle the loan after 3 years.
- A principal amounts to ₹13924 in 2 years by compound interest at 18 p.c.p.a. Find the principal.
- The population of a suburb is 16000. Find the rate of increase in the population if the population after two years is 17640.
- In how many years ₹ 700 will amount to ₹ 847 at a compound interest rate of 10 p.c.p.a.
- Find the difference between simple interest and compound interest on ₹ 20000 at 8 p.c.p.a.

Answers

Practice Set 14.1 1. (1) ₹ 2205, ₹ 205 (2) ₹ 6298.56, ₹ 1298.56

(3) ₹ 4622.5, ₹ 622.5 2. ₹ 17561.60 3. ₹ 1768.2

Practice Set 14.2 1. 500 2. 252 sheep 3. 46,305 trees

4. ₹ 47500 5. ₹ 1036.80 6. ₹ 21073.92 7. ₹ 10,000

8. 5 p.c.p.a 9. In 2 years 10. ₹ 128

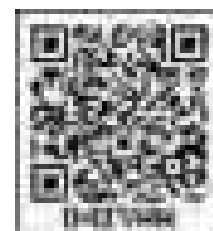



Let's recall.

We know that, if sides of closed polygon are given in the units cm, m, km then their areas are in the units sq cm, sq m and sq km respectively; because the area is measured by squares.

(1) Area of square = side²

(2) Area of rectangle = length \times breadth

(3) Area of right angled triangle
 $= \frac{1}{2} \times$ product of sides making
 right angle

(4) Area of triangle = $\frac{1}{2} \times$ base \times height



Let's learn.

Area of a parallelogram

Activity :

- Draw a big enough parallelogram ABCD on a paper as shown in the figure.

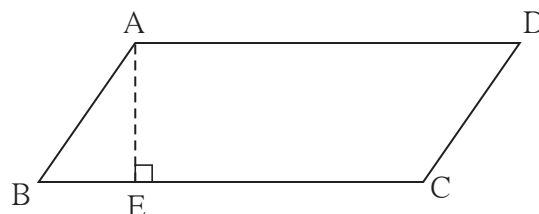

Draw perpendicular AE on side BC.

Cut the right angled \triangle AEB. Join it with the remaining part of \square ABCD as shown in the figure.

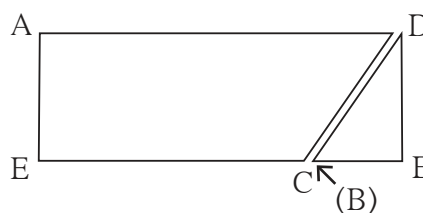

Note that the new figure formed is a rectangle.

- The rectangle is formed from the parallelogram So areas of both the figures are equal.
- Base of parallelogram is one side (length) of the rectangle and its height is the other side (breadth) of the rectangle.

$$\therefore \text{Area of parallelogram} = \text{base} \times \text{height}$$

Remember that, if we consider one of the parallel sides of a parallelogram as a base then the distance between these parallel sides is the height of the parallelogram corresponding to the base.

□ ABCD is a parallelogram.

seg DP ⊥ side BC, seg AR ⊥ side BC.

If side BC is a base then

height = $l(AR) = l(DP) = h$.

If seg CQ ⊥ side AB and if we consider

seg AB as a base then corresponding

height is $l(QC) = k$.

∴ $A(\square ABCD) = l(BC) \times h = l(AB) \times k$.

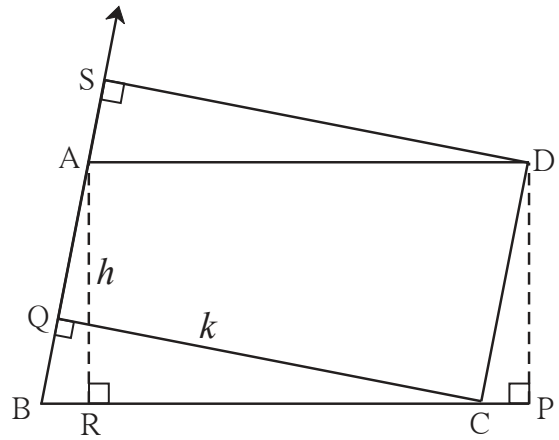

Solved Examples

Ex. (1) If base of a parallelogram is 8 cm and height is 5 cm then find its area.

Solution: Area of a parallelogram = base × height = 8×5
= 40

∴ area of the parallelogram is 40 sq.cm

Ex. (2) If Area of a parallelogram is 112 sq cm and base of it is 10 cm then find its height

Solution: Area of a parallelogram = base × height ∴ $112 = 10 \times \text{height}$

$$\frac{112}{10} = \text{height}$$

∴ height of the parallelogram is 11.2 cm

Practice Set 15.1

1. If base of a parallelogram is 18 cm and its height is 11 cm, find its area.
2. If area of a parallelogram is 29.6 sq cm and its base is 8 cm, find its height.
3. Area of a parallelogram is 83.2 sq cm. If its height is 6.4 cm, find the length of its base.

Area of a rhombus

Activity: Draw a rhombus as shown in the adjacent figure. We know that diagonals of a rhombus are perpendicular bisectors of each other.

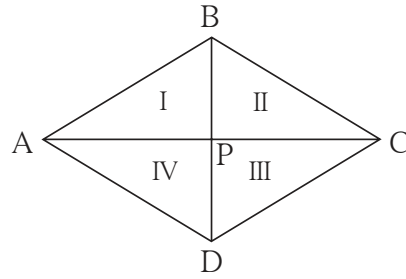

Let $l(AC) = d_1$ and $l(BD) = d_2$

□ ABCD is a rhombus. Its diagonals intersect in the point P. So we get four congruent right angled triangles. Sides of each right angled triangle are $\frac{1}{2} l(AC)$ and $\frac{1}{2} l(BD)$. Areas of all these four triangles are equal.

$$l(AP) = l(PC) = \frac{1}{2} l(AC) = \frac{d_1}{2},$$

$$\text{and } l(BP) = l(PD) = \frac{1}{2} l(BD) = \frac{d_2}{2}$$

$$\begin{aligned}\therefore \text{Area of rhombus ABCD} &= 4 \times A(\Delta APB) \\ &= 4 \times \frac{1}{2} \times l(AP) \times l(BP) \\ &= 2 \times \frac{d_1}{2} \times \frac{d_2}{2} \\ &= \frac{1}{2} \times d_1 \times d_2\end{aligned}$$

\therefore area of a rhombus = $\frac{1}{2} \times$ product of lengths of diagonals.

Solved Examples

Ex. (1) Lengths of the diagonals of a rhombus are 11.2 cm and 7.5 cm respectively. Find the area of rhombus.

$$\begin{aligned}\text{Solution: Area of a rhombus} &= \frac{1}{2} \times \text{product of lengths of the diagonals} \\ &= \frac{1}{2} \times \frac{11.2}{1} \times \frac{7.5}{1} = 5.6 \times 7.5 \\ &= 42 \text{ sq cm}\end{aligned}$$

Ex. (2) Area of a rhombus is 96 sq cm. One of the diagonals is 12 cm find the length of its side.

Solution: Let \square ABCD be a rhombus.

Diagonal BD is of length 12 cm.

Area of the rhombus is 96 sq cm.

So first find the length of diagonal AC.

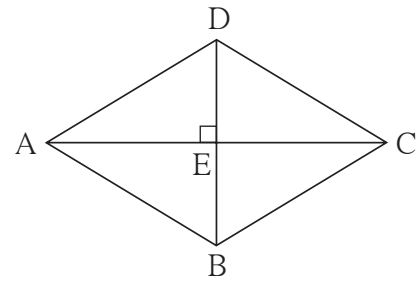

Area of a rhombus = $\frac{1}{2} \times$ product of lengths of diagonals

$$\therefore 96 = \frac{1}{2} \times 12 \times l(AC) = 6 \times l(AC)$$

$$\therefore l(AC) = 16 \text{ cm}$$

Let E be the point of intersection of diagonals of a rhombus. Diagonals are perpendicular bisectors of each other.

\therefore in $\triangle ADE$, $m\angle E = 90^\circ$,

$$l(DE) = \frac{1}{2}l(DB) = \frac{1}{2} \times 12 = 6; \quad l(AE) = \frac{1}{2}l(AC) = \frac{1}{2} \times 16 = 8$$

Using Pythagoras theorem we get,

$$\begin{aligned} l(AD)^2 &= l(AE)^2 + l(DE)^2 = 8^2 + 6^2 \\ &= 64 + 36 = 100 \end{aligned}$$

$$\therefore l(AD) = 10 \text{ cm}$$

\therefore side of the rhombus is 10 cm.

Practice Set 15.2

- Lengths of the diagonals of a rhombus are 15cm and 24 cm, find its area.
- Lengths of the diagonals of a rhombus are 16.5 cm and 14.2 cm, find its area.
- If perimeter of a rhombus is 100 cm and length of one diagonal is 48 cm, what is the area of the quadrilateral?
- 4*** If length of a diagonal of a rhombus is 30 cm and its area is 240 sq cm, find its perimeter.

Area of a trapezium

Activity : Draw a trapezium ABCD on the paper such that seg AB \parallel seg DC.

Draw seg AP \perp seg DC and
seg BQ \perp side DC .
let $l(AP) = l(BQ) = h$

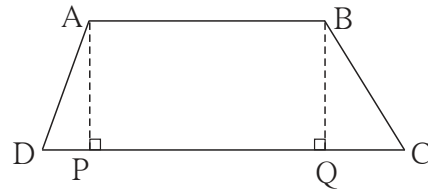

Height of the trapezium is the distance between the parallel sides. After drawing the perpendiculars in \square ABCD, its area is divided into 3 parts. Out of these Δ APD and Δ BQC are right angled triangles.

\square ABQP is a rectangle. points P and Q are on seg DC.

Area of trapezium ABCD

$$\begin{aligned}
 &= A(\Delta APD) + A(\square ABQP) + A(\Delta BQC) \\
 &= \frac{1}{2} \times l(DP) \times h + l(PQ) \times h + \frac{1}{2} l(QC) \times h \\
 &= h \left[\frac{1}{2} l(DP) + l(PQ) + \frac{1}{2} l(QC) \right] \\
 &= \frac{1}{2} \times h [l(DP) + 2l(PQ) + l(QC)] \\
 &= \frac{1}{2} \times h [l(DP) + l(PQ) + l(AB) + l(QC)] \dots \because l(PQ) = l(AB) \\
 &= \frac{1}{2} \times h [l(DP) + l(PQ) + l(QC) + l(AB)] \\
 &= \frac{1}{2} \times h [l(DC) + l(AB)]
 \end{aligned}$$

$$A(\square ABCD) = \frac{1}{2} (\text{sum of the lengths of parallel sides}) \times h$$

\therefore Area of the trapezium = $\frac{1}{2} \times$ sum of the lengths of parallel sides \times height

Solved Example

Ex. (1) In a trapezium, if distance between parallel sides is 6 cm and lengths of the parallel sides are 7 cm and 8 cm respectively then find the area of the trapezium.

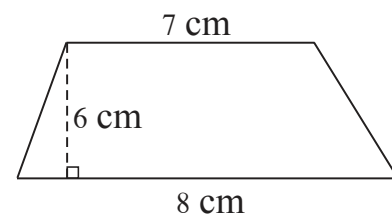

Solution : Distance between parallel sides = height of the trapezium = 6 cm

$$\begin{aligned} \text{Area of the trapezium} &= \frac{1}{2} \times (\text{sum of the lengths of parallel sides}) \times \text{height} \\ &= \frac{1}{2} (7 + 8) \times 6 = 45 \text{ sq cm} \end{aligned}$$

Practice Set 15.3

1. In \square ABCD, $l(AB) = 13$ cm, $l(DC) = 9$ cm, $l(AD) = 8$ cm, find the area of \square ABCD.

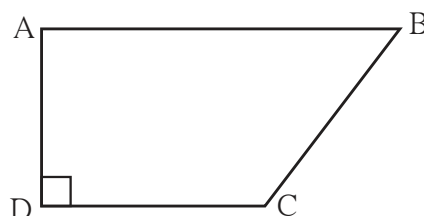

2. Length of the two parallel sides of a trapezium are 8.5 cm and 11.5 cm respectively and its height is 4.2 cm, find its area.

- 3*. \square PQRS is an isosceles trapezium $l(PQ) = 7$ cm. seg $PM \perp$ seg SR , $l(SM) = 3$ cm, Distance between two parallel sides is 4 cm, find the area of \square PQRS

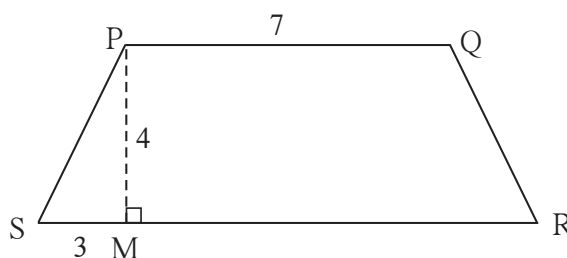

Let's learn.

Area of a Triangle

We know that, Area of a triangle = $\frac{1}{2}$ base \times height.

Now we will see how to find the area of a triangle if height is not given but lengths of the three sides of a triangle are given.

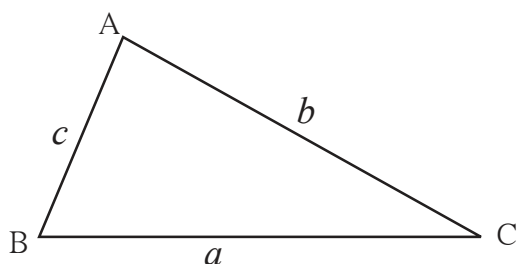

Let a, b, c be the lengths of sides BC, AC and AB respectively of Δ ABC. Let us find the semiperimeter of the triangle.

$$\text{semiperimeter} = s = \frac{1}{2} (a + b + c)$$

$$\text{Area of the triangle} = \sqrt{s(s-a)(s-b)(s-c)}$$

This formula is known as Heron's Formula.

Ex. (1) If the sides of a triangle are 17 cm, 25 cm and 26 cm, find the area of the triangle.

Solution: Here, $a = 17$, $b = 25$, $c = 26$

$$\text{semiperimeter} = s = \frac{a+b+c}{2} = \frac{17+25+26}{2} = \frac{68}{2} = 34$$

$$\begin{aligned} \text{Area of triangle} &= \sqrt{s(s-a)(s-b)(s-c)} \\ &= \sqrt{34(34-17)(34-25)(34-26)} \\ &= \sqrt{34 \times 17 \times 9 \times 8} \\ &= \sqrt{17 \times 2 \times 17 \times 3 \times 3 \times 2 \times 2 \times 2} \\ &= \sqrt{17^2 \times 2^2 \times 2^2 \times 3^2} \\ &= 17 \times 2 \times 2 \times 3 = 204 \text{ sq cm} \end{aligned}$$

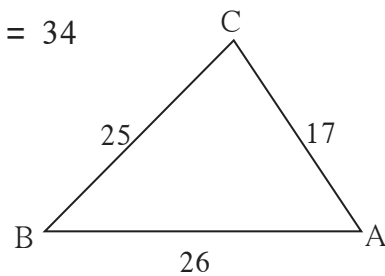

Ex. (2) The figure of a plot and its measures are given.

$$l(LM) = 60 \text{ m. } l(MN) = 60 \text{ m.}$$

$$l(LN) = 96 \text{ m. } l(OP) = 70 \text{ m.}$$

find the area of the plot.

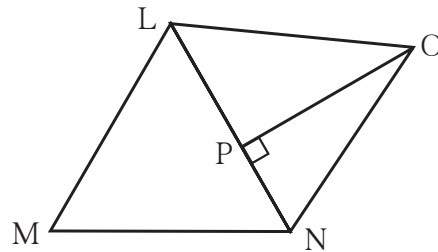

Solution: In the figure we get two triangles, ΔLMN and ΔLNO . We know the lengths of all sides of ΔLMN so by using Heron's formula we will find the area of this triangle. In ΔLNO , side LN is the base and $l(OP)$ is the height. We will find the area of ΔLNO .

$$\text{Semiperimeter of } \Delta LMN, s = \frac{60+60+96}{2} = \frac{216}{2} = 108 \text{ m}$$

$$\begin{aligned} \therefore \text{Area of } \Delta LMN &= \sqrt{108(108-60)(108-60)(108-96)} \\ &= \sqrt{108 \times 48 \times 48 \times 12} \\ &= \sqrt{12 \times 9 \times 48 \times 48 \times 12} \end{aligned}$$

$$A(\Delta LMN) = 12 \times 3 \times 48 = 1728 \text{ sq m}$$

$$A(\Delta LNO) = \frac{1}{2} \text{ base} \times \text{height}$$

$$= \frac{1}{2} \times 96 \times 70 = 96 \times 35 = 3360 \text{ sq m}$$

$$\text{Area of } \square LMNO = A(\Delta LMN) + A(\Delta LNO)$$

$$= 1728 + 3360$$

$$= 5088 \text{ sq m}$$

Area of the plot LMNO is 5088 sq m



Now I know.

Area of a parallelogram = base \times height

Area of a rhombus = $\frac{1}{2} \times$ product of lengths of diagonals

Area of a trapezium = $\frac{1}{2} \times$ sum of the lengths of parallel sides \times height

If sides of ΔABC are a, b, c then Heron's formula for finding the area of triangle is as follows

$$A(\Delta ABC) = \sqrt{s(s-a)(s-b)(s-c)} \text{ where } s = \frac{a+b+c}{2}$$

Practice Set 15.4

1. Sides of a triangle are cm 45 cm, 39 cm and 42 cm, find its area.

2. Look at the measures shown in the adjacent figure and find the area of $\square PQRS$.

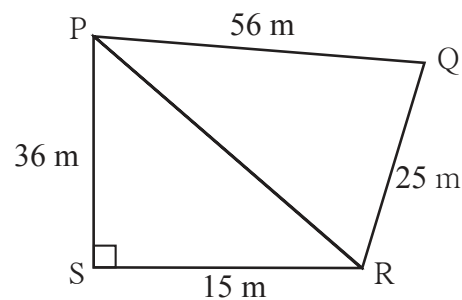

3. Some measures are given in the adjacent figure, find the area of $\square ABCD$.

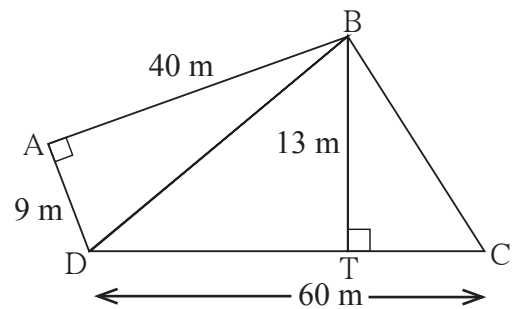

Let's learn.

Area of figures having irregular shape

Generally the plots, fields ect. are of the shape of irregular polygons. These polygons can be divided into triangles and specific quadrilaterals. Study the following examples to know how the polygons are divided and their areas are calculated.

Ex. Adjacent figure is a polygon ABCDE. All given measures are in metre. Find the area of the given figure.

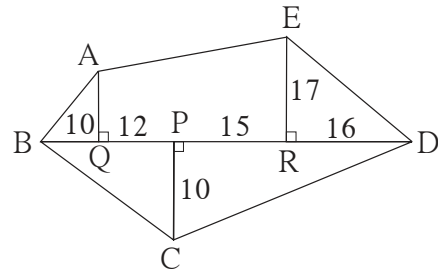

Proof: Here Δ AQB, Δ ERD are right angled triangles and \square AQRE is a trapezium. Base and height of Δ BCD is given. Now let us find the area of each figure.

$$A(\Delta \text{ AQB}) = \frac{1}{2} \times l(\text{BQ}) \times l(\text{AQ}) = \frac{1}{2} \times 10 \times 13 = 65 \text{ sq m}$$

$$A(\Delta \text{ ERD}) = \frac{1}{2} \times l(\text{RD}) \times l(\text{ER}) = \frac{1}{2} \times 16 \times 17 = 136 \text{ sq m}$$

$$\begin{aligned} A(\square \text{ AQRE}) &= \frac{1}{2} [l(\text{AQ}) + l(\text{ER})] \times l(\text{QR}) \\ &= \frac{1}{2} [13 + 17] \times (12 + 15) \\ &= \frac{1}{2} \times 30 \times 27 = 15 \times 27 = 405 \text{ sq m} \end{aligned}$$

$$l(\text{BD}) = l(\text{BP}) + l(\text{PD}) = 10 + 12 + 15 + 16 = 53 \text{ m}$$

$$A(\Delta \text{ BCD}) = \frac{1}{2} \times l(\text{BD}) \times l(\text{PC}) = \frac{1}{2} \times 53 \times 10 = 265 \text{ sq m}$$

$$\begin{aligned} \therefore \text{Area of polygon ABCDE} &= A(\Delta \text{ AQB}) + A(\square \text{ AQRE}) + A(\Delta \text{ ERD}) + A(\Delta \text{ BCD}) \\ &= 65 + 405 + 136 + 265 \\ &= 871 \text{ sq m} \end{aligned}$$

Practice Set 15.5

1. Find the areas of given plots. (All measures are in metres.)

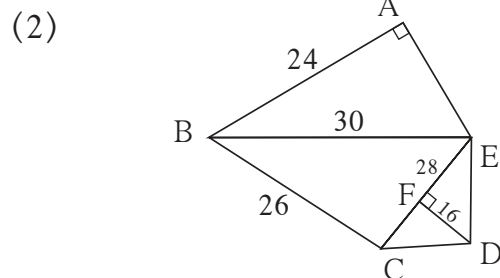
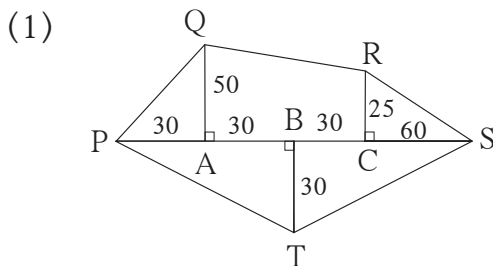

Area of a circle

Activity : Draw a circle on a card sheet. Cut the circle from the sheet. Divide the circular paper into 16 or 32 equal parts by paper folding or make 18 or 20 equal parts by dividing 360° in equal parts. Then get the sectors by cutting them along the radii. Join all these sectors as shown in the figure. We get nearly a rectangle. As we go on increasing the number of parts of the circle, the shape of the figure is more and more like that of a rectangle.

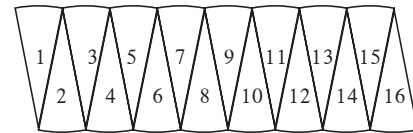
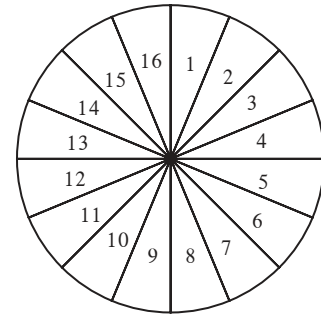

Circumference of a circle = $2\pi r$

\therefore length of the rectangle is πr , that is semicircumference and breadth is r .

\therefore Area of the circle = area of rectangle = length \times breadth = $\pi r \times r$

\therefore Area of the circle = πr^2

Solved Examples

Ex. (1) If radius of a circle is 21 cm then find its area.

Solution: Area of circle = πr^2

$$= \frac{22}{7} \times 21^2$$

$$= \frac{22}{7} \times \frac{21}{1} \times \frac{21}{1} = 66 \times 21 = 1386 \text{ sq cm.}$$

Ex. (2) Area of a circular ground is 3850 sq m. Find the radius of the circular ground.

Solution : Area of the circular ground = πr^2

$$3850 = \frac{22}{7} \times r^2$$

$$r^2 = \frac{3850 \times 7}{22} \quad r^2 = 1225 \quad r = 35 \text{ m.}$$

\therefore Radius of the ground is 35 m.

Practice Set 15.6

1. Radii of the circles are given below, find their areas.

- (1) 28 cm (2) 10.5 cm (3) 17.5 cm

2. Areas of some circles are given below find their diameters.

- (1) 176 sq cm (2) 394.24 sq cm (3) 12474 sq cm

3. Diameter of the circular garden is 42 m. There is a 3.5 m wide road around the garden. Find the area of the road.

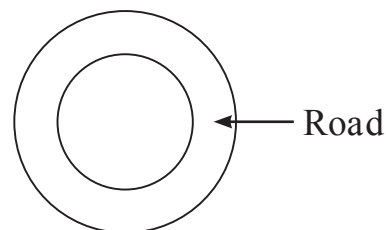

4. Find the area of the circle if its circumference is 88 cm.

To find the approximate area of irregular figure.

Area of the irregular closed figure can be calculated approximately by using graph paper. Draw an outline of the given piece of object on the graph paper with pencil. Let us learn from the activity how the area of the given figure is calculated by counting the number of squares on the graph paper.

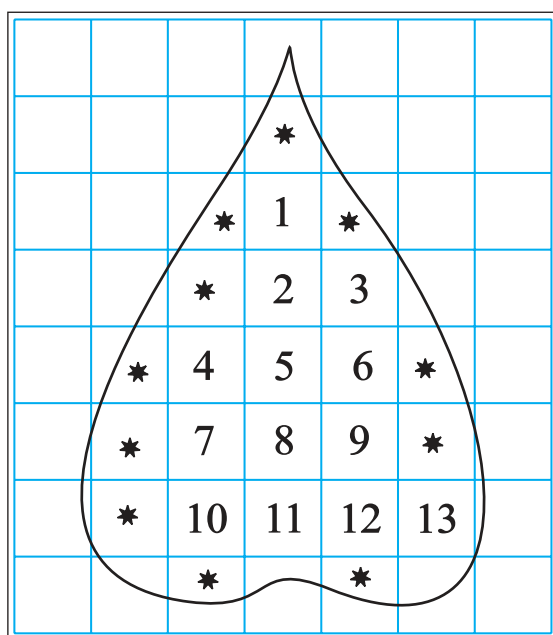

- (1) The number of complete squares of area 1 sq cm = 13
 \therefore Area of those squares is
 $= 13 \text{ sq cm}$
- (2) In the figure the number of parts having area more than $\frac{1}{2}$ sq cm but less than 1 sq cm = 11
 \therefore Area of these parts = 11 sq cm
- (3) From the figure, number of parts having area $\frac{1}{2}$ sq cm = 0
 \therefore Area of these parts = 0 sq cm

(4) From the figure count the parts having area less than $\frac{1}{2}$ sqcm such parts are not to be considered. \therefore Area of these parts = 0 sq cm
 \therefore Total area = 13 + 11 + 0 + 0 = 24 sq cm

Activity : Draw a circle of radius 28mm. Draw any one triangle and draw a trapezium on the graph paper. Find the area of these figures by counting the number of small squares on the graph paper. Verify your answers using formula for area of these figures.

Observe that the smaller the squares of graph paper, better is the approximation of area.

For more information :

Our nation has adopted the decimal system of measurement. So in the revenue department areas of lands are recorded in decimal units, Are and Hectare

100 sq m = 1 are, 100 are = 1 hectare = 10,000 sq m

In practice often area of land is measured in ‘Guntha’ or ‘Acre’.

1 Guntha land area is approximately 1 are. Which is nearly 100 sq m. 1 acre area is nearly 0.4 hectare.



Answers

- Practice Set 15.1** 1. 198 sq cm 2. 3.7 cm 3. 13 cm
- Practice Set 15.2** 1. 180 sq cm 2. 117.15 sq cm 3. 336 sq cm 4. 68 cm
- Practice Set 15.3** 1. 88 sq cm 2. 42 cm 3. 40 sq cm
- Practice Set 15.4** 1. 756 sq cm 2. 690 sq cm 3. 570 sq cm
- Practice Set 15.5** 1. 6000 sq m 2. 776 sq m
- Practice Set 15.6** 1. (1) 2464 sq cm (2) 346.5 sq cm (3) 962.5 sq cm
 2. (1) $2\sqrt{56}$ cm (2) 22.4 cm (3) 126 cm
 3. 500.50 sq m 4. 616 sq cm

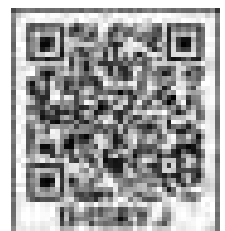

16

Surface area and Volume

Let's recall.

Total surface area of a cuboid = $2(l \times b + b \times h + l \times h)$

Total surface area of a cube = $6l^2$

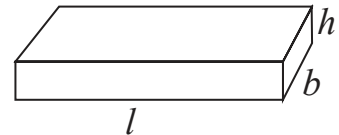
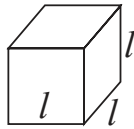

$$1 \text{ m} = 100 \text{ cm}$$

$$1 \text{ sq m} = 100 \times 100 \text{ sq cm} = 10000 \text{ sq cm} = 10^4 \text{ sq cm}$$

$$1 \text{ cm} = 10 \text{ mm}$$

$$1 \text{ sq cm} = 10 \times 10 \text{ sq mm} = 100 \text{ sq mm} = 10^2 \text{ sq mm}$$

Let's learn.

Cuboid, cube, cylinder etc are three dimensional solid figures. **These solid figures occupy some space . The measure of the space occupied by a solid is called the volume of the solid.**

Standard unit of volume

The cube with side 1 cm is shown in the adjoining figure. The space occupied by this cube is a standard unit of volume. It is written as 1 cubic centimeter. In short it is written as 1 cc or 1 cm^3 .

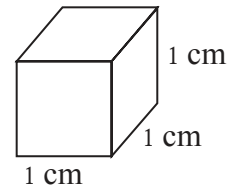

Activity I : Get some cubes with side 1 cm. Arrange 6 such cubes as shown in figure. We get a cuboid of length 3 cm, breadth 2 cm and height 1 cm. Note that the volume of the cuboid is $3 \times 2 \times 1 = 6 \text{ cc}$.

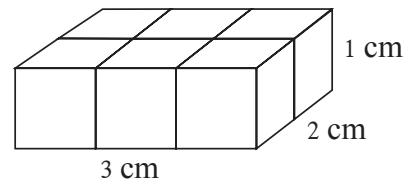

Activity II : The length, breadth and height of the adjoining cuboid is 3 cm, 2 cm and

2 cm respectively. In this cuboid there are

$3 \times 2 \times 2 = 12$ cubes of volume 1 cc each.

From this we get the formula,

volume of a cuboid = length \times breadth \times height.

Taking l for length, b for breadth and h for height,

Volume of a cuboid = $l \times b \times h$

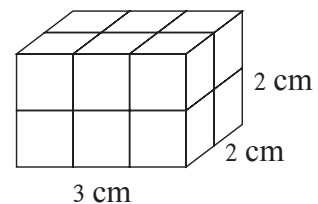

Activity III :

In the adjoining figure 8 cubes each of volume 1 cc are arranged. By this arrangement we get a cube of side 2 cm. Note that volume of this cube = $2 \times 2 \times 2 = 2^3$

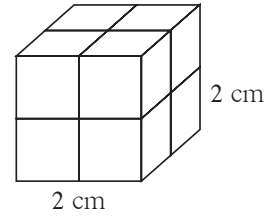

From this if the side of cube is l then **volume of the cube** = $l \times l \times l = l^3$.

Volume of liquid: Space occupied by a liquid in the container is its volume. We know that units used for measuring the volume of liquid are millilitre and litre.

An empty cube of side 10 cm is shown in the adjoining figure.

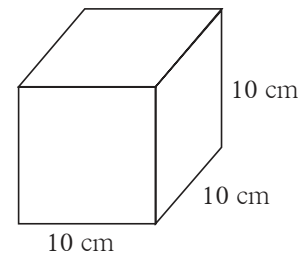

Its volume = $10 \times 10 \times 10 = 1000$ cc. If this cube is filled with water the volume of water will also be 1000 cc. This volume is called 1 litre .

We know that 1 litre = 1000 millilitre

\therefore 1 litre = 1000 cc = 1000 ml, hence 1 cc = 1 ml

The volume of water filled in a cube of side 1 cm is 1 ml.

Solved Examples

Ex. (1) Find how many litre of water will a cuboidal fish tank contain if its length, breadth and height are 1 m, 40 cm and 50 cm respectively.

Solution: The water contained in the tank is equal to volume of the tank.

Length of tank = 1m = 100cm, breadth = 40cm,
height = 50cm.

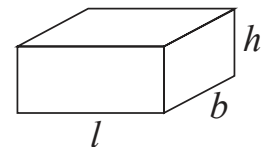

\therefore Volume of the tank = $l \times b \times h = 100 \times 40 \times 50 = 200000$ cc,

Volume of water in the tank = 200000 cc = $\frac{200000}{1000} = 200$ litre
(\because 1000 cc = 1l)

\therefore Tank will contain 200 litre of water

Ex. (2) The length and height of a cuboidal warehouse is 6m, 4m and 4m respectively. How many cube shaped boxes of side 40 cm will fill the warehouse completely ?

Solution : When all the boxes are arranged to fill the warehouse completely the total volume of all boxes equals the volume of the warehouse. To solve the example we will consider the following steps.

- (1) Find volume of warehouse
- (2) Find volume of a box.
- (3) Find the number of boxes

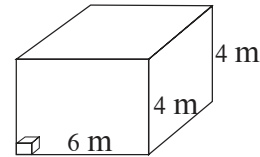

Step (1): Length of warehouse = 6 m = 600 cm, breadth = height = 4 m = 400 cm

$$\text{Volume of warehouse} = l \times b \times h = 600 \times 400 \times 400 \text{ cc}$$

Step (2): Volume of a box = $l^3 = (40)^3 = 40 \times 40 \times 40 \text{ cc}$

$$\text{Step (3): Number of boxes} = \frac{\text{volume of warehouse}}{\text{volume of a box}} = \frac{600 \times 400 \times 400}{40 \times 40 \times 40} = 1500$$

\therefore 1500 boxes will fill the warehouse completely.

Ex. (3) If 5 litre molten mixture of khoa and sugar is poured in a tray it fills to its full capacity. Find the length of the tray if its breadth is 40 cm and height is 2.5 cm

Solution: To solve the example fill the empty boxes with suitable numbers.

Step (1) : Capacity of tray = 5 litre = cc (\because 1 litre = 1000 cc)

Step (2) : Volume of mixture = cc

Step (3) : Volume of rectangular tray = volume of mixture

$$l \times b \times h = \text{ cc}$$

$$\text{length} \times 40 \times 2.5 = \text{ cc}, \quad \therefore \text{length} = \frac{\text{}}{100} = 50 \text{ cm}$$



Now I know.

- Volume of cuboid = length \times breadth \times height = $l \times b \times h$
- Volume of cube = side³ = l^3

Practice Set 16.1

1. Find the volume of a box if its length, breadth and height are 20 cm, 10.5 cm and 8 cm respectively.
2. A cuboid shape soap bar has volume 150 cc. Find its thickness if its length is 10 cm and breadth is 5 cm.
3. How many bricks of length 25 cm, breadth 15 cm and height 10 cm are required to build a wall of length 6 m, height 2.5 m and breadth 0.5 m?

4. For rain water harvesting a tank of length 10 m, breadth 6 m and depth 3m is built. What is the capacity of the tank ? How many litre of water can it hold?



Let's learn.

Surface area of cylinder

Take a cylinder shaped container. Take a rectangular paper sheet whose breadth is equal to the height of the container. Wrap the paper around the container such that it will exactly cover the curved surface area of container. Cut off the remaining paper.

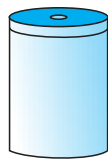

Cylindrical container

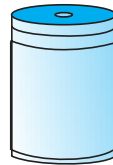

Paper wrapped

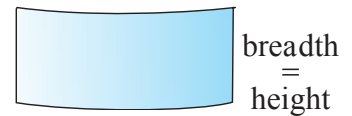

Length = Circumference of the circle

Unwrap the covered paper. It is a rectangle. Area of this rectangle equals the area of curved surface of cylinder.

Length of the rectangle is the circumference of circle and breadth is height of the cylinder.

$$\begin{aligned} \text{Curved surface area of cylinder} &= \text{Area of rectangle} = \text{length} \times \text{breadth} \\ &= \text{circumference of the base of the cylinder} \times \text{height of the cylinder} \\ &= 2\pi r \times h = 2\pi rh \end{aligned}$$

The upper and the lower surface of the closed cylinder is circular

$$\therefore \text{total surface area of closed cylinder} = \text{curved surface area} + \text{area of upper surface} + \text{area of lower surface}$$

$$\begin{aligned} \therefore \text{total surface area} &= \text{curved surface area} + 2 \times \text{area of circular faces} \\ &= 2\pi rh + 2\pi r^2 = 2\pi r(h + r) \end{aligned}$$

Solved examples

Ex. (1) A water tank of cylindrical shape has diameter 1 m and height 2 m. Tank is closed with lid. The tank is to be painted internally and externally including the lid.

Find the expenditure if the rate of painting is ₹ 80 per sqm. ($\pi = 3.14$)

Solution: The tank is to be painted internally and externally. It means that the area to be painted is twice the total surface area.

The diameter of base of cylinder is 1 m

∴ radius is 0.5 m and height of cylinder is 2 m.

$$\begin{aligned}\therefore \text{total surface area of cylinder} &= 2\pi r (h + r) = 2 \times 3.14 \times 0.5 (2.0 + 0.5) \\ &= 2 \times 3.14 \times 0.5 \times 2.5 = 7.85 \text{ sqm}\end{aligned}$$

∴ the area of the surface to be painted = $2 \times 7.85 = 15.70$ sqm

∴ the total expenditure of painting the tank = $15.70 \times 80 = ₹1256$.

Ex. (2) A zinc sheet is of length 3.3 m and breadth 3 m. How many pipes of length 30 cm and radius 3.5 cm can be made from this sheet?

Solution: Area of rectangular sheet = length \times breadth

$$= 3.3 \times 3 \text{ sqm} = 330 \times 300 \text{ sqcm}$$

Length of pipe is same as the height of cylinder = $h = 30$ cm

Radius of pipe = Radius of base of cylinder = $r = 3.5$ cm,

The sheet required for a pipe = curved surface area of one pipe

$$\begin{aligned}&= 2\pi rh = 2 \times \frac{22}{7} \times \frac{35}{10} \times \frac{30}{1} \\ &= 2 \times 22 \times 15 = 660 \text{ sqcm}\end{aligned}$$

$$\text{Number of pipes made from the sheet} = \frac{\text{Area of sheet}}{\text{Curved surface area of a pipe}}$$

$$= \frac{330 \times 300}{660} = 150$$

∴ from the zinc sheet 150 pipes can be made.

Practice Set 16.2

- In each example given below, radius of base of a cylinder and its height are given. Then find the curved surface area and total surface area.
(1) $r = 7$ cm, $h = 10$ cm (2) $r = 1.4$ cm, $h = 2.1$ cm (3) $r = 2.5$ cm, $h = 7$ cm
(4) $r = 70$ cm, $h = 1.4$ cm (5) $r = 4.2$ cm, $h = 14$ cm
- Find the total surface area of a closed cylindrical drum if its diameter is 50 cm and height is 45 cm. ($\pi = 3.14$)

3. Find the area of base and radius of a cylinder if its curved surface area is 660 sqcm and height is 21 cm
4. Find the area of the sheet required to make a cylindrical container which is open at one side and whose diameter is 28 cm and height is 20 cm. Find the approximate area of the sheet required to make a lid of height 2 cm for this container.



Let's learn.

Volume of a cylinder

To find how much water a tank of cylindrical shape can hold, we have to find the volume of the tank.

A common formula for volume of any prism = area of base \times height

Base of a cylinder is circular. \therefore volume of a cylinder = $\pi r^2 h$

Solved Examples

Ex. (1) Find the volume of a cylinder whose height is 10 cm and radius of base is 5 cm ($\pi = 3.14$)

Solution : Radius of base of cylinder $r = 5$ cm and height $h = 10$ cm

$$\text{volume of cylinder} = \pi r^2 h = 3.14 \times 5^2 \times 10 = 3.14 \times 25 \times 10 = 785 \text{ cc.}$$

Ex. (2) Height of a cylindrical drum is 56 cm. Find the radius of the drum if the capacity of that drum is 70.4 litre. ($\pi = \frac{22}{7}$)

Solution : Let the radius of cylindrical drum be = r

$$\text{capacity of drum} = \text{volume of drum} = 70.4 \times 1000 \text{ cc}$$

$$1 \text{ litre} = 1000 \text{ ml} \therefore 70.4 \text{ litre} = 70400 \text{ ml}$$

$$\therefore \text{volume of water} = \pi r^2 h = 70400$$

$$\therefore r^2 = \frac{70400}{\pi h} = \frac{70400 \times 7}{22 \times 56} = \frac{70400}{22 \times 8} = \frac{8800}{22} = 400$$

$$\therefore r = 20, \quad \therefore \text{radius of the drum is 20 cm.}$$

Ex. (3) Radius of a solid copper cylinder is 4.2 cm and its height is 16 cm. How many discs of diameter 1.4 cm and thickness 0.2 cm can be made from this cylinder melting it.

Solution: Radius of the base of the cylinder = $R = 4.2$ cm

height of the cylinder = $H = 16$ cm

Volume of cylinder = $\pi R^2 H = \pi \times 4.2 \times 4.2 \times 16.0$

Radius of the base of the disc = $1.4 \div 2 = 0.7$ cm

Thickness of disc = height of disc = 0.2 cm

Volume of a disc = $\pi r^2 h = \pi \times 0.7 \times 0.7 \times 0.2$

Let n discs be made from the molten cylinder.

$\therefore n \times$ volume of one disc = volume of cylinder

$$n = \frac{\text{Volume of cylinder}}{\text{Volume of one disc}} = \frac{\pi R^2 H}{\pi r^2 h} = \frac{R^2 H}{r^2 h} = \frac{4.2 \times 4.2 \times 16}{0.7 \times 0.7 \times 0.2}$$

$$= \frac{42 \times 42 \times 160}{7 \times 7 \times 2} = 6 \times 6 \times 80 = 2880$$

\therefore 2880 discs will be made from the cylinder.

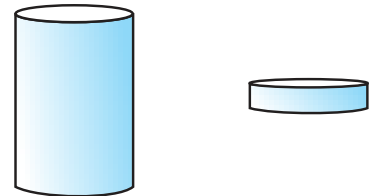

Now I know.

Curved surface area of cylinder = $2\pi rh$

Total surface area of cylinder = $2\pi r(h + r)$

Volume of cylinder = $\pi r^2 h$



Practice Set 16.3

- Find the volume of the cylinder if height (h) and radius of the base (r) are as given below.
 - $r = 10.5$ cm, $h = 8$ cm
 - $r = 2.5$ m, $h = 7$ m
 - $r = 4.2$ cm, $h = 5$ cm
 - $r = 5.6$ cm, $h = 5$ cm
- How much iron is needed to make a rod of length 90 cm and diameter 1.4 cm?
- How much water will a tank hold if the interior diameter of the tank is 1.6 m and its depth is 0.7 m ?
- Find the volume of the cylinder if the circumference of the cylinder is 132 cm and height is 25 cm.

Euler's Formula :

Leonard Euler, a great mathematician, at a very young age discovered an interesting formula regarding the faces, vertices and edges of solid figures.

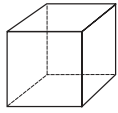
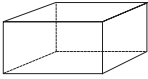
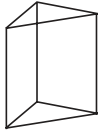
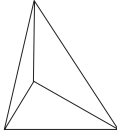
Count and write the faces, vertices and edges of the following figures and complete the table. From the table verify Euler's formula, $F + V = E + 2$.

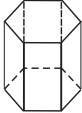
Name	Cube	Cuboid	Triangular Prism	Triangular pyramid	Pentagonal pyramid	Hexagonal prism
Shapes						
Faces (F)	6					8
Vertices (V)	8					12
Edges (E)		12			10	

kkk

Answers

Practice Set 16.1

1. 1680 c cm 2. 3 cm 3. 2000 bricks 4. 1,80,000 litre.

Practice Set 16.2

1. (1) 440 sq cm, 748 sq cm (2) 18.48 sq cm, 30.80 sq cm
(3) 110 sq cm, 149.29 sq cm (4) 616 sq cm, 31416 sq cm
(5) 369.60 sq cm, 480.48 sq cm
2. 10,990 sq cm 3. 5 cm, 78.50 sq cm
4. 2376 sq cm, the approximate area for lid is 792 sq cm.

Practice Set 16.3

1. (1) 2772 c cm (2) 137.5 c m (3) 277.2 c cm (4) 492.8 c cm
2. 138.6 c cm 3. 1408 litre 4. 34650 c cm

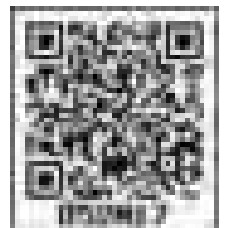



Let's recall.

In the adjoining figure O is the centre of the circle.

With reference to the figure fill in the blanks.

- Seg OD is of the circle.
- Seg AB is of the circle.
- Seg PQ is of the circle.
- is the central angle.
- Minor arc : arc AXD, arc BD,,,
- Major arc : arc PAB, arc PDQ,
- Semicircular arc : arc ADB,....
- $m(\text{arc DB}) = m\angle \dots\dots\dots$ • $m(\text{arc DAB}) = 360^\circ - m\angle \dots\dots\dots$

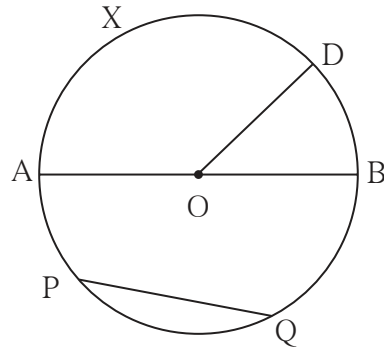

Let's learn.

Properties of chord of a circle

Activity I :

Draw chord AB of a circle with centre O.

Draw perpendicular OP to chord AB .

Measure seg AP and seg PB.

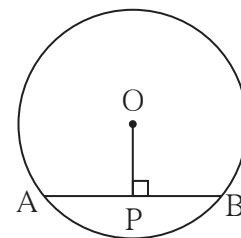

Draw five circles with different radii. Draw a chord and perpendicular from the centre to each chord in each circle. Verify with a divider that the two parts of the chords are equal. You will get the following property.

**The perpendicular drawn from the centre of a circle
to its chord bisects the chord.**

Activity II:

Draw five circles of different radii on a paper. Draw a chord in each circle. Find the midpoint of each chord. Join the centre of the circle and midpoint of the chord as shown in the figure. Name the chord as AB and midpoint of the chord as P. Check with set - square or protractor that $\angle APO$ or $\angle BPO$ are right angles.

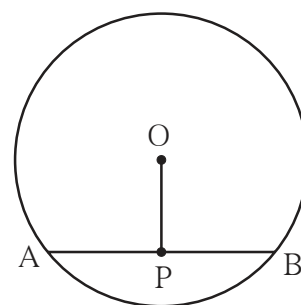

Check whether the same result is observed for the chord of each circle. You will get the following property.

The segment joining the centre of a circle and midpoint of its chord is perpendicular to the chord.

Solved Examples

Ex. (1) In a circle with centre O, seg PQ is a chord of length 7 cm. seg OA \perp chord PQ, then find $l(AP)$.

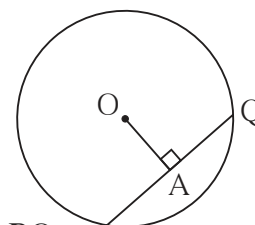

Solution: Seg OA \perp chord PQ, \therefore point A is midpoint of chord PQ

$$\therefore l(PA) = \frac{1}{2} l(PQ) = \frac{1}{2} \times 7 = 3.5 \text{ cm}$$

Ex. (2) Radius of a circle with centre O is 10 cm. Find the length of the chord if the chord is at a distance of 6 cm from the centre.

Solution: Distance of the chord from the centre of the circle is the length of perpendicular drawn from the centre of the circle to the chord.

AB is the chord of the circle with centre O.

seg OP \perp chord AB.

Radius of the circle = $l(OB) = 10$ cm.

$l(OP) = 6$ cm. $\triangle OPB$ is a right angled triangle.

According to Pythagoras theorem,

$$[l(OP)]^2 + [l(PB)]^2 = [l(OB)]^2$$

$$\therefore 6^2 + [l(PB)]^2 = 10^2$$

$$\therefore [l(PB)]^2 = 10^2 - 6^2$$

$$\therefore [l(PB)]^2 = (10 + 6)(10 - 6) = 16 \times 4 = 64$$

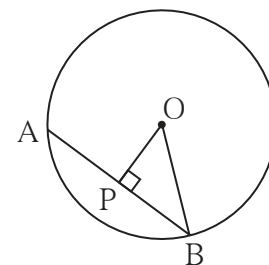

$$\therefore l(PB) = 8 \text{ cm.}$$

We know that, the perpendicular drawn from centre of the circle to the chord bisects the chord.

$$\therefore l(AB) = 2 \times l(PB) = 2 \times 8 = 16$$

\therefore length of chord AB is 16 cm.

Practice Set 17.1

- In a circle with centre P, chord AB is drawn of length 13 cm, seg PQ \perp chord AB, then find $l(QB)$.
- Radius of a circle with centre O is 25 cm. Find the distance of a chord from the centre if length of the chord is 48 cm.
- O is centre of the circle. Find the length of radius, if the chord of length 24 cm is at a distance of 9 cm from the centre of the circle.

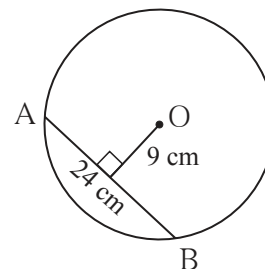
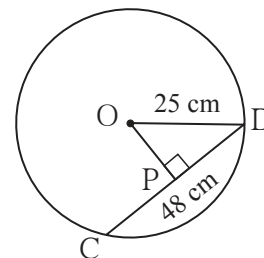
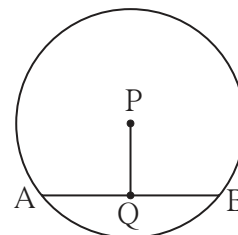

- C is the centre of the circle whose radius is 10 cm. Find the distance of the chord from the centre if the length of the chord is 12 cm.



Let's learn.

Arcs corresponding to the chord of a circle

In the adjoining figure, seg AB is a chord of a circle with centre O. Arc AXB is minor arc and arc AYB is a major arc. These two arcs are called corresponding arcs of chord AB. Moreover chord AB is called corresponding chord of arc AXB and arc AYB.

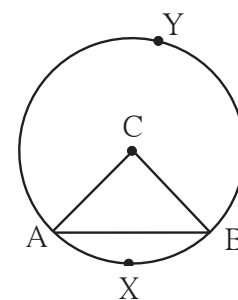

Congruent arcs

If the measures of two arcs of circle are same then two arcs are congruent.

In the circle with centre O

$$\therefore m\angle AOB = m\angle COD$$

$$\therefore m(\text{arc AXB}) = m(\text{arc CYD})$$

$$\therefore \text{arc AXB} \cong \text{arc CYD}$$

Verify this using tracing paper.

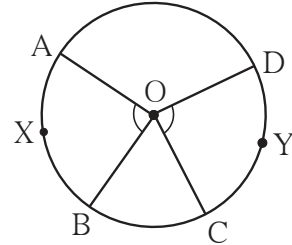

With the help of following activity find out the properties of the chord and the corresponding arc and remember them.

Activity I :

- (1) Draw a circle with centre O
- (2) Draw $\angle COD$ and $\angle AOB$ of same measure. You will find that the arc AXB and arc CYD are congruent.

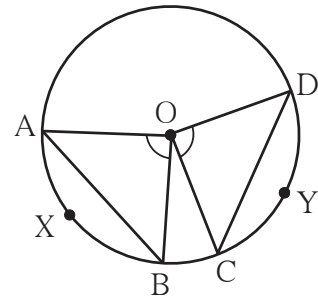

- (3) Draw chords AB and CD.
- (4) Using compass experience that the length of chord AB and chord CD is also same.

Activity II :

- (1) Draw a circle with centre C.
- (2) Draw the congruent chords AB and DE of the circle. Draw the radii CA, CB, CD and CE.
- (3) Check that $\angle ACB$ and $\angle DCE$ are congruent.
- (4) Hence show that measure of arc AB and arc DE is equal. Hence these arcs are congruent.

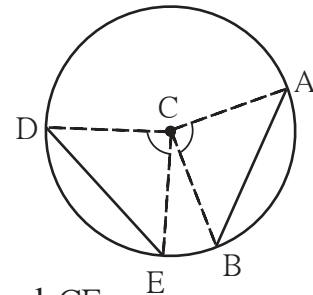

Now I know.

The chords corresponding to congruent arcs are congruent. In a circle if two chords are congruent then their corresponding minor arcs and major arcs are congruent

Practice Set 17.2

1. The diameters PQ and RS of the circle with centre C are perpendicular to each other at C. State, why arc PS and arc SQ are congruent. Write the other arcs which are congruent to arc PS
2. In the adjoining figure O is the centre of the circle whose diameter is MN. Measures of some central angles are given in the figure. Hence find the following
 - (1) $m\angle AOB$ and $m\angle COD$
 - (2) Show that arc $AB \cong$ arc CD .
 - (3) Show that chord $AB \cong$ chord CD

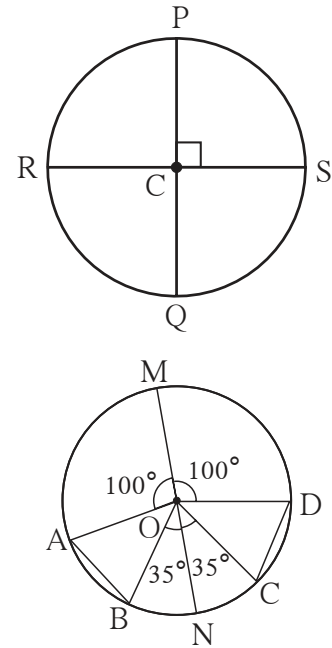

Answers

Practice Set 17.1

1. 6.5 cm 2. 7 cm 3. 15 cm 4. 8 cm

Practice Set 17.2

1. (1) Because the arcs are of equal measures, that is 90° each.
 (2) arc $PS \cong$ arc $PR \cong$ arc RQ
2. (1) $m\angle AOB = m\angle COD = 45^\circ$
 (2) arc $AB \cong$ arc CD because the arcs are of equal measures that is 45° each.
 (3) chord $AB \cong$ chord CD because corresponding chords of congruent arcs are congruent.

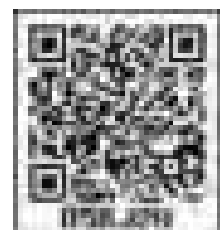

Miscellaneous Exercise 2

1. Questions and their alternative answers are given. Choose the correct alternative answer.
 - (1) Find the circumference of a circle whose area is 1386 cm^2 .
 (A) 132 cm^2 (B) 132 cm (C) 42 cm (D) 21 cm^2
 - (2) The side of a cube is 4 m . If it is doubled, how many times will be the volume of the new cube, as compared with the original cube ?
 (A) Two times (B) Three times (C) Four times (D) Eight times
2. Pranalee was practising for a 100 m running race. She ran 100 m distance 20 times. The time required, in seconds, for each attempt was as follows.
 $18, 17, 17, 16, 15, 16, 15, 14, 16, 15,$
 $15, 17, 15, 16, 15, 17, 16, 15, 14, 15$ Find the mean of the times taken for running.
3. $\triangle DEF$ and $\triangle LMN$ are congruent in the correspondence $EDF \leftrightarrow LMN$. Write the pairs of congruent sides and congruent angles in the correspondence.
4. The cost of a machine is ₹ $2,50,000$. It depreciates at the rate of 4% per annum. Find the cost of the machine after three years.
5. In $\square ABCD$ side $AB \parallel$ side DC , seg $AE \perp$ seg DC . If $l(AB) = 9 \text{ cm}$, $l(AE) = 10 \text{ cm}$, $A(\square ABCD) = 115 \text{ cm}^2$, find $l(DC)$.
6. The diameter and height of a cylindrical tank is 1.75 m and 3.2 m respectively. How much is the capacity of tank in litre ? ($\pi = \frac{22}{7}$)
7. The length of a chord of a circle of 16.8 cm , radius is 9.1 cm . Find its distance from the centre.
8. The following tables shows the number of male and female workers, under employment gurantee scheme, in villages A, B, C and D.

Village	A	B	C	D
No. of females	150	240	90	140
No. of males	225	160	210	110

- (1) Show the information by a sub-divided bar-diagram.
- (2) Show the information by a percentage bar diagram.

9. Solve the following equations.

(1) $17(x+4) + 8(x+6) = 11(x+5) + 15(x+3)$

(2) $\frac{3y}{2} + \frac{y+4}{4} = 5 - \frac{y-2}{4}$ (3) $5(1-2x) = 9(1-x)$

10. Complete the activity according to the given steps.

(1) Draw rhombus ABCD. Draw diagonal AC.

(2) Show the congruent parts in the figure by identical marks.

(3) State by which test and in which correspondence ΔADC and ΔABC are congruent.

(4) Give reason to show $\angle DCA \cong \angle BCA$, and $\angle DAC \cong \angle BAC$

(5) State which property of a rhombus is revealed from the above steps.

11. The shape of a farm is a quadrilateral. Measurements taken of the farm, by naming its corners as P, Q, R, S in order are as follows. $l(PQ) = 170$ m, $l(QR) = 250$ m, $l(RS) = 100$ m, $l(PS) = 240$ m, $l(PR) = 260$ m.

Find the area of the field in hectare (1 hectare = 10,000 sq.m)

12. In a library, 50% of total number of books is of Marathi. The books of English are $\frac{1}{3}$ rd of Marathi books. The books on mathematics are 25% of the English books. The remaining 560 books are of other subjects. What is the total number of books in the library?

13. Divide the polynomial $(6x^3 + 11x^2 - 10x - 7)$ by the binomial $(2x + 1)$. Write the quotient and the remainder.

Answers

1. (1) B (2) D 2. 15.7 second

3. side ED \cong side LM, side DF \cong side MN, side EF \cong side LN, $\angle E \cong \angle L$,

$\angle D \cong \angle M$, $\angle F \cong \angle N$ 4. ₹ 2,21,184 5. 14 cm 6. 7700

7. 3.5 cm 9. (1) $x = 16$, (2) $y = \frac{9}{4}$ (3) $x = -4$ 11. 3.24 hectare

12. 1920 13. $3x^2 + 4x - 7$, remainder 0

इयत्ता ५ वी, ८ वी शिष्यवृत्ती परीक्षा मार्गदर्शिका



- मराठी, इंग्रजी, उर्दू, हिंदी माध्यमामध्ये उपलब्ध
- सरावासाठी विविध प्रश्न प्रकारांचा समावेश

- घटकनिहाय प्रश्नांचा समावेश
- नमुन्यादाखल उदाहरणांचे स्पष्टीकरण



पुस्तक मागणीसाठी www.ebalbharati.in, www.balbharati.in संकेत स्थळावर भेट द्या.

**साहित्य पाठ्यपुस्तक मंडळाच्या विभागीय भांडारांमध्ये
विक्रीसाठी उपलब्ध आहे.**



ebalbharati

विभागीय भांडारे संपर्क क्रमांक : पुणे - ☎ २५६५९४६५, कोल्हापूर- ☎ २४६८५७६, मुंबई (गोरेगाव)
- ☎ २८७७९८४२, पनवेल - ☎ २७४६२६४६५, नाशिक - ☎ २३९१५११, औरंगाबाद - ☎
२३३२१७१, नागपूर - ☎ २५४७७१६/२५२३०७८, लातूर - ☎ २२०९३०, अमरावती - ☎ २५३०९६५

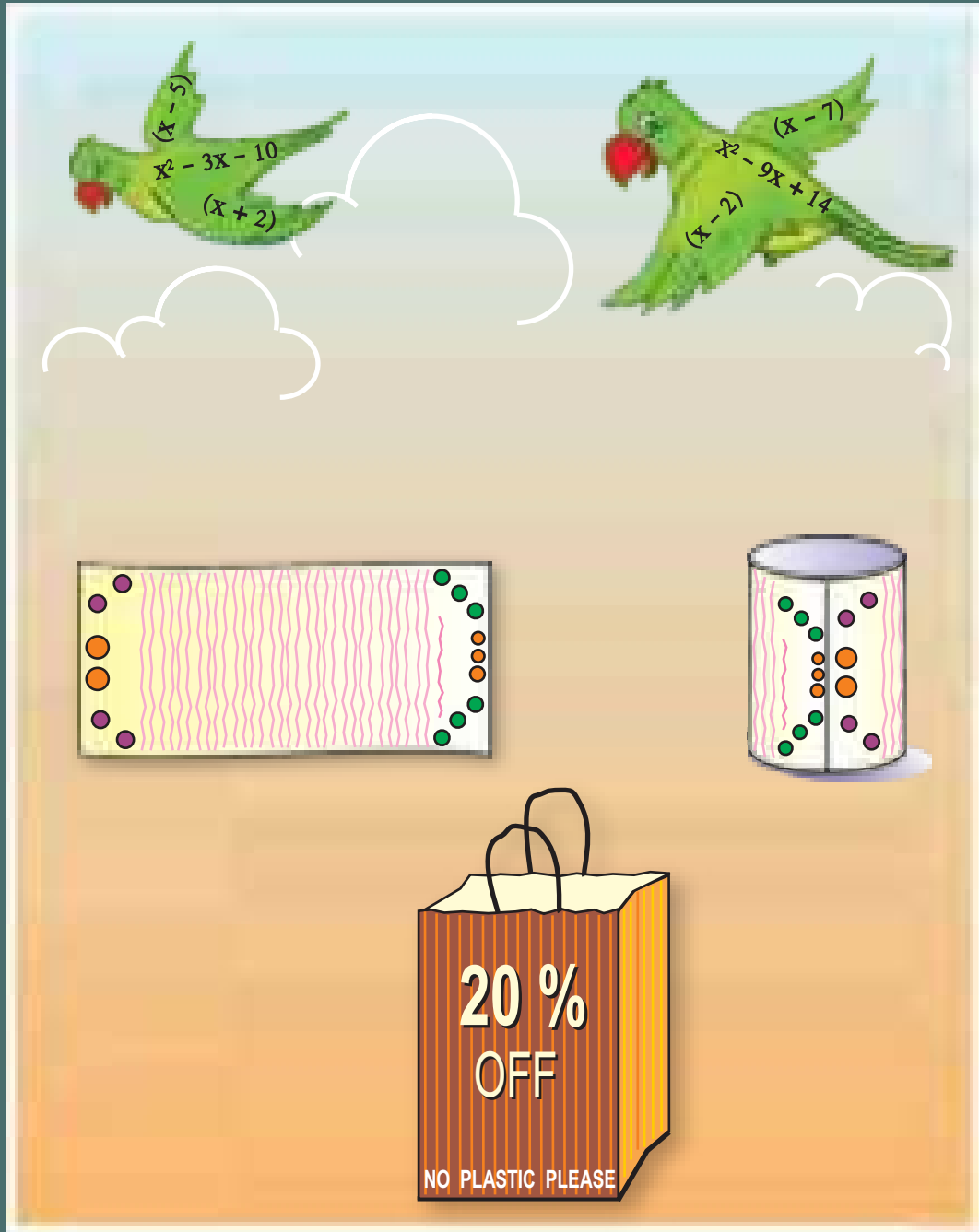

Maharashtra State Bureau of Textbook Production and Curriculum Research,
Pune.

इंग्रजी गणित इ.८ वी

₹ 48.00